



KC200 series general vector inverter User manual V1.1

Shenzhen Kinco Electric Co., LTD
en.kinco.cn

Preface

Thank you for purchasing the KC200 inverter developed by Kinco Electric (Shenzhen) Ltd.!

KC200 is a general vector inverter , mainly used to control and adjust the speed and torque of three-phase AC asynchronous motor and three-phase permanent magnet synchronous motor. It can be used to drive textiles, machine tools, packaging, food, fans, water pumps and various automated production equipment . This manual introduces the product's installation and wiring, parameter settings, function applications, fault countermeasures, maintenance and other detailed information.

Please read this user manual carefully before use. At the same time, please use the product only after fully understanding the safety precautions of the product.

Important Notes

After unpacking, please confirm whether the product packaging has been damaged during transportation.

In order to illustrate the details of the product, the illustrations in this manual sometimes show the state of the product with the outer casing or safety cover removed. When using this product, be sure to install the casing or cover as specified and operate in accordance with the instructions in the manual.

The illustrations in this manual are for illustration only and may differ from the product you ordered.

The company is committed to continuous product improvement and product functions will be continuously upgraded. The information provided is subject to change without prior notice.

If there is any problem with any of the above, please contact our company or your supplier to solve it.

Version change record

Version	Update Date	Update Content
V1.0	2024-09	First Edition Release
V1.1	2024-11	Add information about synchronous motor in sections 5.6, 7.2, 7.6, 7.7, 7.24, 7.25

Content

Preface	1
Important Notes	1
Version change record	1
1 Security information	7
1.1 Security definition	7
1.2 Security claims	7
1.3 Precautions for use	9
1.3.1 Motor and mechanical load	9
1.3.2 About the AC drive	10
1.4 Precautions for scrapping	11
2 Product information	12
2.1 Product confirmation	12
2.2 Nameplate and model number	12
2.3 Technical specification	12
2.4 Product series introduction	15
2.5 AC drive structure	16
2.6 Overall dimensions and gross weight	16
2.6.1 Dimensions and gross weight of the AC drive	16
2.6.2 Dimensions of the operation Panel and installation box	18
2.7 Installation requirements	20
3 System interface and wiring	21
3.1 Electrical wiring diagram	21
3.2 Peripheral system configuration	22
3.2.1 Main circuit terminal wiring and configuration	23
3.2.1.1 Main loop input/output terminal type	23
3.2.1.2 AC drive main circuit wiring method	24
3.2.2 Control circuit terminal wiring and configuration	24
3.2.2.1 Wiring of control loop terminals	24
3.2.2.2 Analog input terminal wiring	27
3.2.2.3 Analog output terminal wiring	27
3.2.2.4 Multi-function input terminal and operation control terminal wiring	28
3.2.2.5 Multi-Function Output Terminal Wiring	31
3.2.2.6 Relay output terminal (TA1-TB1-TC1, TA2-TB2-TC2) wiring	32
4 Operation panel layout and operating instructions	33
4.1 Operation panel layout	33
4.1.1 Appearance and key function description of the operation panel	33
4.1.1.1 Status indicator light	34
4.1.1.2 Data display	35
4.2 Menu description	36
4.3 Status parameter display	36
4.4 Parameter setting	38

4.5 M Multifunction Key Operation	38
4.6 Operation panel drive motor	39
5 Function introduction	41
5.1 Operation command setting	41
5.1.1 Run command channel setting	41
5.1.2 Operating panel control	41
5.1.3 Terminal I/O control	41
5.1.4 Communication control	43
5.2 Frequency reference sources	45
5.2.1 Setting frequency reference sources	45
5.2.2 Selecting source of main frequency reference	45
5.2.3 Setting main frequency through operating panel	46
5.2.4 Setting main frequency through analog input (AI Or Panel Potentiometer)	47
5.2.5 Setting the main frequency through communication	51
5.2.6 Setting main frequency through pulse input	53
5.2.7 Setting main frequency through PID	54
5.2.8 Setting main frequency through multi-reference	56
5.2.9 Setting the main frequency through simple PLC	57
5.2.10 Select the input method of auxiliary frequency command	58
5.2.11 Setting frequency based on main and auxiliary frequency references	58
5.2.12 Run command to bind main frequency command	60
5.2.13 Action setting below lower limit frequency	61
5.2.14 Setting frequency reference limits	61
5.2.15 Skip frequency	61
5.3 Jogging	62
5.4 Start-stop instruction	63
5.4.1 Startup mode	63
5.4.1.1 Direct start	63
5.4.1.2 Pre-excitation start	65
5.4.1.3 Speed tracking start	65
5.4.2 Stop mode	65
5.4.2.1 Decelerate to stop	65
5.4.2.2 Coast to stop	67
5.4.3 Acceleration and deceleration time setting	67
5.5 Control terminal	69
5.5.1 Digital input terminal	69
5.5.2 Analog input terminal	69
5.5.3 Digital output terminal	69
5.5.4 Analog output terminal	70
5.6 Motor configuration	70
5.6.1 Motor control mode selection	70
5.6.2 Motor parameter self-learning	71
5.7 Control performance	72
5.7.1 Speed loop and torque limit	72
5.7.1.1 Speed loop	72
5.7.1.2 Speed control torque upper limit	73
5.7.1.3 Torque control speed limit	74
5.7.1.4 Vector Control Slip Gain	75
5.7.2 Current loop	75
5.7.3 Over-current control	76
5.7.4 Over-voltage control	77
5.7.5 Under Voltage Control (Instant Stop Without Stopping)	78
5.8 Introduction to application function	79

5.8.1	Frequency detection	79
5.8.1.1	Frequency detection (FDT)	79
5.8.1.2	Frequency reaches detection amplitude	81
5.8.1.3	Any arrival frequency detection value	82
5.8.2	Current detection	82
5.8.2.1	Zero-current Detection	82
5.8.2.2	Output current exceeding limit detection	83
5.8.2.3	Arbitrary arrival current detection	84
5.8.3	Forward and reverse instruction	85
5.8.3.1	Forward and reverse dead - time	85
5.8.3.2	Reverse frequency prohibition and rotation direction selection	85
5.9	Introduction of auxiliary function	86
5.9.1	Hibernation and wakeup	86
5.9.2	Swing frequency control function	87
5.9.3	Fixed length function	88
5.9.4	Timing function	89
5.9.5	Counting function	90
5.9.6	Simple PLC function	91
5.10	User password	93
5.11	Parameter initialization and upload-download	94
5.11.1	Initialize (restore default Setting)	94
5.11.2	Upload and download	94
5.12	Fault and protection	94
5.12.1	Startup protection	95
5.12.2	Undervoltage/Overvoltage threshold	95
5.12.3	Phase loss protection	95
5.12.4	Fault resetting	96
5.12.5	Fault action protection selection	97
6	Troubleshooting	98
6.1	Common Faults and Diagnosis	98
6.1.1	Alarm and Fault Display	98
6.1.2	Restart upon faults	98
6.1.3	Common troubleshooting	99
6.1.4	Different control mode under trial operation treatment countermeasures	100
6.1.4.1	V/F Control Mode(VF control is not recommended for synchronous motor)	100
6.1.4.2	Vector control mode	100
6.2	List of fault codes	101
7	Quick list of function parameters	106
7.1	Parameter terminology description	106
7.2	Parameters list	106
7.3	Group F00: Environmental applications	106
7.4	Group F01: Basic parameters group	107
7.5	Group F02: Start/Stop control parameters	110
7.6	Group F03: Motor parameters	112
7.7	Group F04: Motor 1 encoder parameters	113
7.8	Group F05: V/f control parameters	113
7.9	Group F06: Speed loop and torque control parameters	115
7.10	Group F07: Current loop and flux control parameters	116

7.11 Group F08: DI terminal function parameters.....	117
7.12 Group F09: AI terminal function parameters.....	118
7.13 Group F10: DO terminal function Parameters.....	121
7.14 Group F11: AO terminal function parameters.....	122
7.15 Group F12: Auxiliary function parameters.....	123
7.16 Group F13: Protection Parameters.....	124
7.17 Group F14: Communication parameters.....	127
7.18 Group F15: Display parameters.....	132
7.19 Group F16: PID parameters.....	133
7.20 Group F17: Multi-reference parameters.....	134
7.21 Group F18: Extended terminal parameters.....	137
7.22 Group F19 : Communication mapping parameters.....	138
7.23 Group A00: Advanced performance parameters.....	139
7.24 Group A03: Motor 2 parameters.....	140
7.25 Group A04: Motor 2 encoder parameters.....	140
7.26 Group A05: Motor 2 V/F control parameters.....	141
7.27 Group A06: Motor 2 speed loop and torque control parameters.....	143
7.28 Group A07: Motor 2 current loop and magnetic flux control parameters.....	144
7.29 Group D0x: Monitoring parameters.....	144
7.29.1 Group D00: Status monitoring parameters.....	144
7.29.2 Group D01: Fault monitoring parameters.....	145
7.29.3 Group D02: System information.....	147
7.30 Input terminal function.....	147
7.31 Output terminal function.....	148
7.32 Fault code table.....	149
8 Inspection, maintenance and assurance.....	150
8.1 Inspection.....	150
8.2 Maintenance.....	151
8.3 Product Warranty.....	151
9 Accessory Recommendation.....	152
9.1 Braking Resistors.....	152
9.2 EMC Filter.....	152
9.2.1 External filters are available for single-phase models.....	152
9.2.2 External filters are available for three-phase models.....	153
9.2.3 Installation requirement.....	153
9.3 Common EMC problems and solutions.....	154
9.3.1 Ground cables and grounding issues.....	154
9.3.2 ESD discharge issues.....	154
9.3.3 Transient interference.....	154
9.3.4 Harness interference.....	154
9.3.5 Power supply fluctuation and inrush current.....	155
9.3.6 Leakage protection circuit breaker works incorrectly.....	155



9.3.7 Control loop interference	155
9.3.8 Communication interference	156
9.4 Other Optional Accessories	156
10 Compliance with certification standards	157
10.1 CE Certification	157
10.2 Meet the requirements of the EMC directive	157
Appendix 1: Modbus Communication Protocol	158
Appendix II: CANopen communication protocol	162

1 Security information

To ensure safe and reasonable use of this product, please fully understand the safety information described in this manual before using this product . Our company does not assume any legal responsibility for personal injury and equipment damage caused by failure to comply with the contents of the manual or illegal operation of the product.

1.1 Security definition

The following symbols are used in this manual to indicate important safety information. Failure to observe these precautions may result in personal injury, death, or damage to this product and associated systems.

	<p>Danger The information marked as dangerous is crucial for avoiding safety accidents.</p>
	<p>Warnings The information marked as a warning is necessary to avoid damaging the product or other equipment.</p>
<p>Note</p>	<p>Note The information marked as Note is helpful in ensuring proper operation of the product.</p>

1.2 Security claims

Operating qualifications

This product must be operated by trained professionals. In addition, operators must receive professional skills training, be familiar with the installation, wiring, operation and maintenance of equipment, and correctly respond to various emergencies that occur during use.

Unpacking and Acceptance

<p>Note</p>	<p>Attention!</p> <ul style="list-style-type: none"> ● Before unpacking, first check whether the appearance of the package is normal and intact, without obvious scratches, extrusion deformation, damage, or be affected with damp. For safety reasons, do not use products with damaged packaging or parts. ● Please verify that the model number and quantity match the order information as per the order list inside the box and the nameplate information on the product. ● Please confirm whether all terminal accessories are complete and there are no defects or rust on the surface of the product.
--------------------	--

Storage and Transportation

	<p>Warnings!</p> <p>During transportation, do not let the operating panel and cover plate be under pressure, otherwise there is a risk of personal injury or damage to property when the product falls. AC drive stored for more than 2 years should be gradually boosted with a voltage regulator when powered on, otherwise there is a risk of electric shock and explosion. Please store the product according to the specified requirements. The storage environment should be dry, free from corrosive gases, non-conductive dust, and direct sunlight. The temperature should be maintained below 60°C. During transportation and storage, precautions should be taken to avoid impacts and vibrations on the AC drive, as there is a risk of product damage.</p>
---	--

Installation requirements



Warnings!

- Install in a place that can withstand the weight of the AC drive, otherwise there is a risk of injury or damage to property when dropped.
- Please ensure that the installation is secure and the screws are tightened to prevent the product from falling and damaging during use.
- Before powering on the product, it must be installed in the electrical cabinet and ensure that all protective measures have been activated.
- During operation, it is strictly forbidden to touch the heat sink, fan, braking resistor, and other components of the product to check the temperature, as there is a risk of burns.
- This product must be installed inside an electrical enclosure when in use, and all protective measures must be activated.
- In applications with severe dust, metal debris, and oil pollution, equipment electrical cabinets with good sealing should be used.
- Due to the pulse waveform of the output voltage of the AC drive, if there are capacitors or lightning protection varistors installed on the output side to improve power factor, please be sure to remove or modify them on the input side of the AC drive.
- Please refer to Chapter 2 for instructions on installing equipment and retaining sufficient heat dissipation space. If the ambient temperature inside the cabinet exceeds the allowable range, it is necessary to consider derating for use.
- Static electricity in the human body can seriously damage internal sensitive devices. Before carrying out relevant operations, please follow the measures and methods specified in the Static Electricity Prevention Measures (ESD), otherwise the frequency converter may be damaged.

Danger!



- Please install on metal or other flame-retardant objects. Flammable objects are prohibited from touching/attaching to the product, otherwise there is a danger of fire..
- Do not install or use the product in environments with corrosive substances such as hydrogen sulfide, sulfur dioxide, chlorine gas, ammonia, sulfur, corrosive gases, acids, alkalis, salts, or in proximity to flammable gas environments and combustible materials, as it may pose a risk of fire.
- If there is any damage to the product surface or if any components are missing, please do not install or operate it, as it may pose a risk of fire or injury.
- Foreign objects such as screws, metal spacers, and metal rods that fall inside the AC drive pose a risk of fire and damage to property.
- Wiring operations must be carried out by a professionally qualified person, otherwise there is a risk of electric shock.
- Make sure that the input power is completely disconnected before wiring, otherwise there is a risk of electric shock.
- The grounding terminal of the AC drive must be reliably grounded, with a grounding resistance less than 10Ω, otherwise there is a risk of electric shock.
- The RB+ and RB- terminals are used to connect the braking resistor, and must not be shorted, otherwise the product may be damaged or cause a fire.
- Please do not add circuit breakers or contactors and other switching devices on the output side of the AC drive, if there are special working condition requirements, please contact the manufacturer for further communication.
- This product controls a potentially hazardous motion mechanism. Failure to comply with the regulations or to operate in accordance with this manual may result in personal injury or death and damage to the product and related systems.
- Please make sure that the power supply meets the requirements of the product before powering up, otherwise the product may be damaged or cause fire.
- Before powering up, please make sure that the terminals are connected reliably, the cables are connected tightly, and the protective cover must be put on, otherwise there is a risk of electric shock and explosion.
- Do not touch the product and terminals under power-on conditions, and do not disassemble the parts of the product, otherwise there is a risk of electric shock.
- Maintenance operations should be carried out after disconnecting the power supply for 10 minutes, at which time the charging indicator light is completely off or it is confirmed that the positive and negative bus voltages are below 36V, otherwise there is a risk of electric shock.
- Parts must be replaced only by a professional. It is strictly forbidden to leave wires or metal objects inside the machine, otherwise there is a risk of fire.
- After replacing the control board, the parameters must be set correctly before operation, otherwise there is a risk of damage to property.

1.3 Precautions for use

When using the KC200 series AC drive, please pay attention to the following points :

1.3.1 Motor and mechanical load

Compared with power frequency operation

The KC200 series AC drive is a voltage-type AC drive. The output voltage is a PWM wave and contains certain harmonics. Therefore, the temperature rise, noise and vibration of the motor during use increase slightly compared with power frequency operation.

Constant torque low speed operation

When the AC drive drives an ordinary motor to run at low speed for a long time, the output torque rating must be reduced due to the poor heat dissipation effect of the motor. If long-term operation at low speed and constant torque is required, a variable frequency motor must be selected.

Electronic thermal protection value of motor

When an adapted motor is selected, the AC drive can implement thermal protection for the motor. If the rated capacity of the motor and the AC drive do not match, the protection value must be adjusted or other protective measures must be taken to ensure the safe operation of the motor.

Operating at frequencies above 50Hz

If the operation exceeds 50Hz, in addition to considering the increase in vibration and noise of the motor, the operating speed range of the motor bearings and mechanical devices must also be ensured, and be sure to check in advance.

Lubrication of mechanical devices

When mechanical devices that require lubrication, such as reduction boxes and gears, operate at low speeds for a long time, damage may occur due to deterioration of the lubrication effect. Be sure to check in advance.

Negative torque load

For situations such as lifting loads, negative torque often occurs, and the AC drive often trips due to overcurrent or overvoltage faults. At this time, you should consider selecting a braking component with appropriate parameters.

Mechanical resonance point of load device

Within a certain output frequency range, the AC drive may encounter the mechanical resonance point of the load device, which must be avoided by setting the jump frequency.

Frequent starts and stops

It is advisable to control the start and stop of the AC drive through the terminals. It is strictly prohibited to use contactors and other switching devices on the input side of the AC drive for direct and frequent start and stop operations, otherwise the equipment will be damaged.

Motor insulation check before connecting AC drive

Before using the motor for the first time or reusing it after being left for a long time, the motor insulation should be checked to prevent damage to the AC drive due to insulation failure of the motor windings. The wiring is as shown in Figure 1-1. When testing, please use a 500V voltage megohmmeter to ensure that the measured insulation resistance is not less than $5M\ \Omega$.

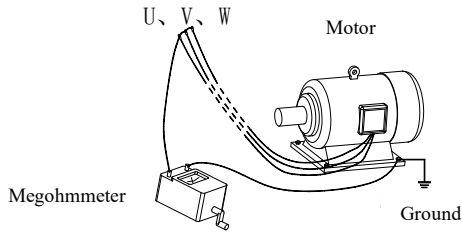

Figure 1-1 Motor insulation inspection diagram

1.3.2 About the AC drive

Capacitors or pressure-sensitive devices to improve power factor

Since the AC drive output is a PWM wave, if a capacitor to improve the power factor or a varistor for lightning protection is installed on the output side, it will cause the AC drive to trip or damage the device, so be sure to remove it. As shown in Figure 1-2.

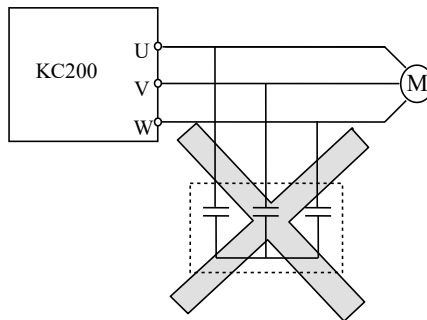

Figure 1-2 Capacitors are prohibited at the output end of the AC drive

The use of switching devices such as contactors installed at the output end of the AC drive

If you need to install a contactor or other switching device between the AC drive output and the motor, please ensure that the AC drive performs on-off operation when there is no output, otherwise the AC drive may be damaged.

Use outside the rated voltage value

It is not suitable to use the KC200 series AC drive outside the allowed operating voltage range. If necessary, please use the corresponding step-up or step-down device for voltage transformation.

Lightning surge protection

The AC drive is equipped with a lightning overcurrent protection device, which has certain self-protection capabilities against induced lightning.

Altitude and derating use

In areas with an altitude of more than 1,000 meters, the heat dissipation effect of the AC drive becomes poor due to the thin air, so it is necessary to derate the AC drive. Figure 1-3 shows the relationship between the rated current of the AC drive and the altitude.

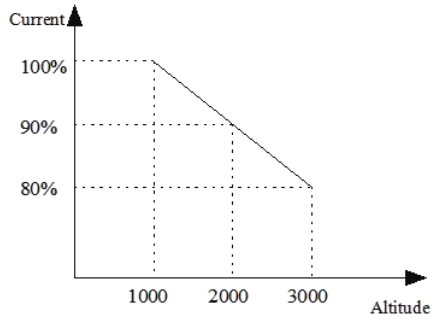

Figure 1-3 Frequency converter rated output current derated with altitude

1.4 Precautions for scrapping

When scrapping the AC drive, please note:

The electrolytic capacitors in the main circuit and the electrolytic capacitors on the printed circuit board may explode when burned. Toxic gases will be produced when plastic parts such as front panels are burned.

Please dispose of it as industrial waste.

2 Product information

2.1 Product confirmation

When you received the AC drive, please check the following items.

- Make sure the package and the unit is in the status as undamaged. And which is same as what you ordered.
- The thing which damaged by transportation isn't on the scope of guarantees, please contact with us by the service line to provide related assistance.

2.2 Nameplate and model number

Nameplate:



Designation rule

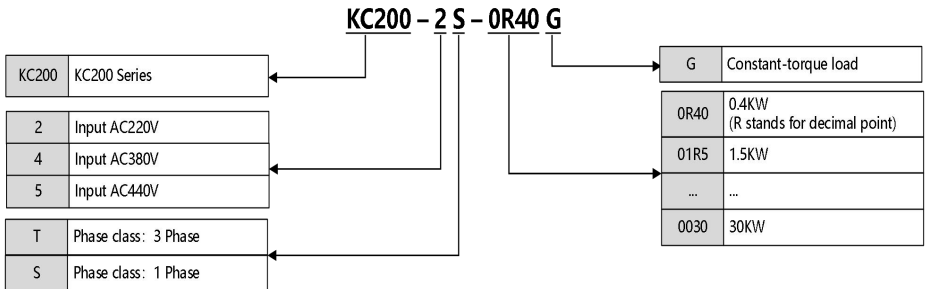

2.3 Technical specification

Table 2-1 General technical specifications

Item		Specification
Input	Rated voltage、Rated frequency	2S: Single phase 200V~240V 50Hz/60Hz; 4T/5T: Three phase 380V~480V 50Hz/60Hz
	Allowable fluctuation range of voltage	-15~10%
	Allowable fluctuation range of frequency	±5%
Output	Output voltage	0-Input voltage
	Maximum output frequency	600Hz

	Item	Specification
	Overload capacity	G type machine: 150% rated current for 60s, 180% rated current for 3s
Main control performance	Motor control method	V/F control, Open loop vector control (SVC), Closed loop vector control (FVC)
	Modulation mode	Space vector PWM modulation
	Maximum carrier frequency	16.0kHz
	Speed control range	Open loop vector control, rated load 1:100; Closed loop vector control, rated load 1:1000
	Steady speed accuracy	Open loop vector control: $\pm 0.5\%$ rated synchronous speed; Closed loop vector control: $\pm 0.02\%$ rated synchronous speed
	Starting torque	Open loop vector control: 150% rated torque at 0.5Hz; Closed loop vector control: 200% rated torque at 0Hz
	Torque response	Open loop vector control: < 20ms; Closed loop vector control: < 10ms
	Frequency accuracy	Digital setting: maximum frequency $\times \pm 0.01\%$; Simulation setting: Maximum frequency $\times \pm 0.2\%$
	Frequency resolution	Digital setting: 0.01Hz; Simulation setting: Maximum frequency $\times 0.05\%$
	Torque boost	Automatic torque boost; Manual torque is increased by 0.1% ~ 30.0%
Product basic functions	DC braking capability	Starting frequency: 0.00Hz ~ 50.00Hz Braking time: 0.0s ~ 60.0s Braking current value: 0% ~ 100% rated current
	V/F curve	Four modes: 1 user set V/F curve mode and 3 torque reduction characteristic curve mode
	Acceleration/ deceleration curve	Straight-line or S-curve acceleration/deceleration; Four groups of acceleration/deceleration time
	Multi-speed running	The product supports up to 16 speeds with the control terminal
	Built-in PID	The function facilitates closed-loop control of process control.
	Auto voltage regulation	When the mains voltage changes, the output voltage keeps constant automatically.
	Overvoltage/overcurrent stall control	Automatic current and voltage limit during operation to prevent frequent overvoltage trip
	Fast current limit	Minimize overcurrent faults and protect the normal operation of the drive
	Instantaneous power failure processing	The load feedback energy compensates for the voltage reduction in the transient power outage and keeps the driver running for a short time
	Running command	Operation panel given, control terminal given, communication control, which can be switched through a variety of ways

Item		Specification
	Frequency reference	Digital setting, analog voltage setting, analog current setting, pulse setting, communication setting
	Auxiliary frequency setting	Realize flexible auxiliary frequency fine-tuning and frequency synthesis
	Input terminal	Six digital input terminals, one of which supports high-speed pulse input up to 100KHz
		Two analog input terminals, one of which supports 0 ~ 10V/0 ~ 20mA input
	Output terminal	Two analog output terminals, both supporting 0 ~ 10V/0 ~ 20mA output
		2 digital output terminals, one of which supports 0.1kHz ~ 100kHz pulse square wave signal output, which can realize the output of physical quantities such as set frequency and output frequency.
2 sets of relay output terminals		
Communication	One 485 communication terminal, one CAN communication terminal	
Keyboard display	LED display	Single line 5-bit nixie tube, built-in keyboard and external keyboard
	Parameter copy	The external keyboard supports uploading and downloading the function parameter information of the AC drive to achieve fast parameter setting
	Condition monitoring	20 parameters such as set frequency, output frequency, output voltage and output current can be displayed
	Fault Alarm	Overvoltage, undervoltage, overcurrent, short circuit, phase loss, overload, overheating, etc
Protect function	Phase absence protection	Input phase loss protection, output phase loss protection
	Over-voltage protection	The main circuit stops when the DC voltage is above 800V
	low-voltage protection	The main circuit stops when the DC voltage is below 350V
	Overheat protection	Trigger protection when the AC drive bridge overheats
	Overload protection	Overload operation, to reach the overload time stop
	Over-current protection	Stop if the AC drive exceeds 2.5 times the rated current
	Short circuit protection	Output interphase short-circuit protection, output short-circuit protection to the ground
Environment	Installation site	In the altitude area of more than 1000 meters, due to the thin air caused by the poor heat dissipation effect of the AC drive, it needs to be derated, and 1% derated for every 100m rise
	Temperature, humidity	-10°C ~ +50°C, +40°C ~ +50°C please use derated, 5%RH ~ 95%RH (no condensation)
	Vibration	Less than 5.9m/s ² (0.6g)
	Storage temperature	-20°C ~ + 60°C
	Protection grade	IP20
	Installation Method	Wall mounted

2.4 Product series introduction

Table 2-2 AC drive series

AC drive type	Power capacity kVA	Input current A	Output current A	Adaptive motor kW
	Single-phase 220v/ three-phase 380v /three-phase 440v,50/60Hz			
KC200-2S-0R40G	1	5.3	2.5	0.4
KC200-2S-0R75G	1.5	8.2	4	0.75
KC200-2S-01R5G	3	14	7.5	1.5
KC200-2S-02R2G	4	23	10	2.2
KC200-4T/5T-0R75G	1.5	3.4	2.3	0.75
KC200-4T/5T-01R5G	2.5	5	3.7	1.5
KC200-4T/5T-02R2G	3.6	5.8	5.5	2.2
KC200-4T/5T-03R7G	5.8	10.5	8.8	3.7
KC200-4T/5T-05R5G	8.6	14.5	13	5.5
KC200-4T/5T-07R5G	11	20.5	17	7.5
KC200-4T/5T-0011G	16.5	26	25	11
KC200-4T/5T-0015G	21	35	32	15
KC200-4T/5T-0018G	24.5	38.5	37	18.5
KC200-4T/5T-0022G	29.5	46.5	45	22
KC200-4T/5T-0030G	39.5	62	60	30
KC200-4T/5T-0037G	49.5	76	75	37
KC200-4T/5T-0045G	59	92	90	45
KC200-4T/5T-0055G	72.5	113	110	55
KC200-4T/5T-0075G	100	157	152	75
KC200-4T/5T-0090G	116	180	176	90
KC200-4T/5T-0110G	138	260	210	110
KC200-4T/5T-0132G	166	232	252	132
KC200-4T/5T-0160G	200	282	304	160
KC200-4T/5T-0185G	230	326	350	185
KC200-4T/5T-0200G	250	352	380	200
KC200-4T/5T-0220G	280	385	426	220
KC200-4T/5T-0250G	309	437	470	250
KC200-4T/5T-0280G	342	491	520	280
KC200-4T/5T-0315G	395	580	600	315
KC200-4T/5T-0355G	437.5	624	665	355
KC200-4T/5T-0400G	629	670	725	400
KC200-4T/5T-0450G	715	792	820	450
KC200-4T/5T-0500G	800	835	950	500
KC200-4T/5T-0560G	896	920	1020	560

2.5 AC drive structure

The structure of the AC drive is shown in the following figure.

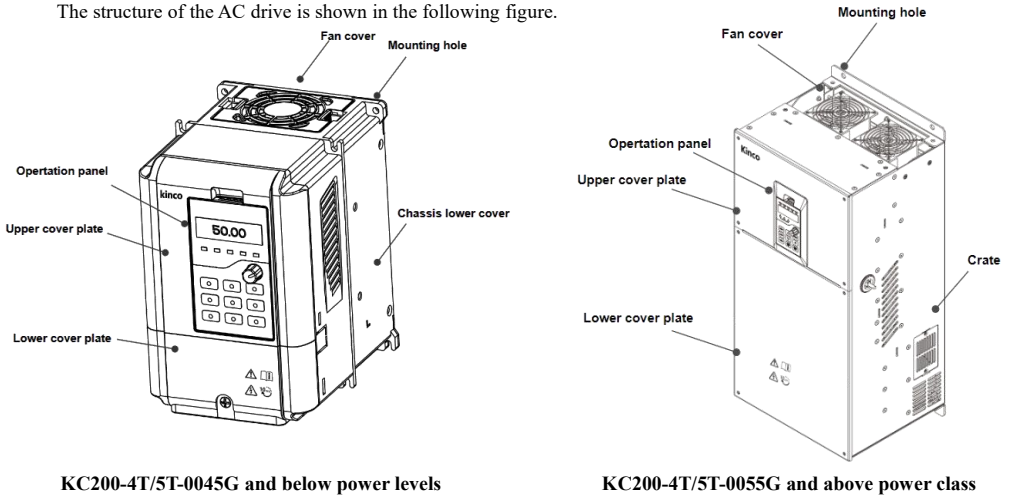

KC200-4T/5T-0045G and below power levels

KC200-4T/5T-0055G and above power class

Figure 2-1 Structure of the frequency converter

2.6 Overall dimensions and gross weight

2.6.1 Dimensions and gross weight of the AC drive

The dimensions of the AC drive are shown in the figure below

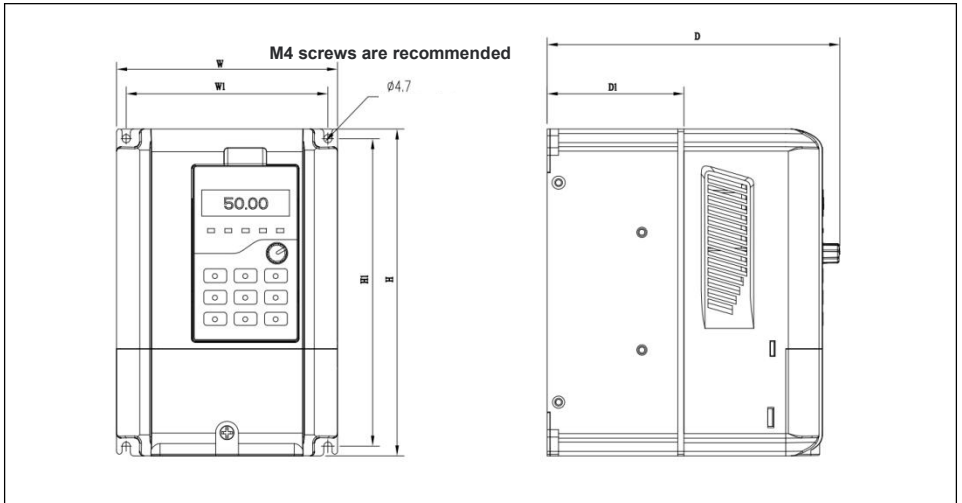

Figure 2-2 KC200-4T/5T-0045G AC drive with lower power

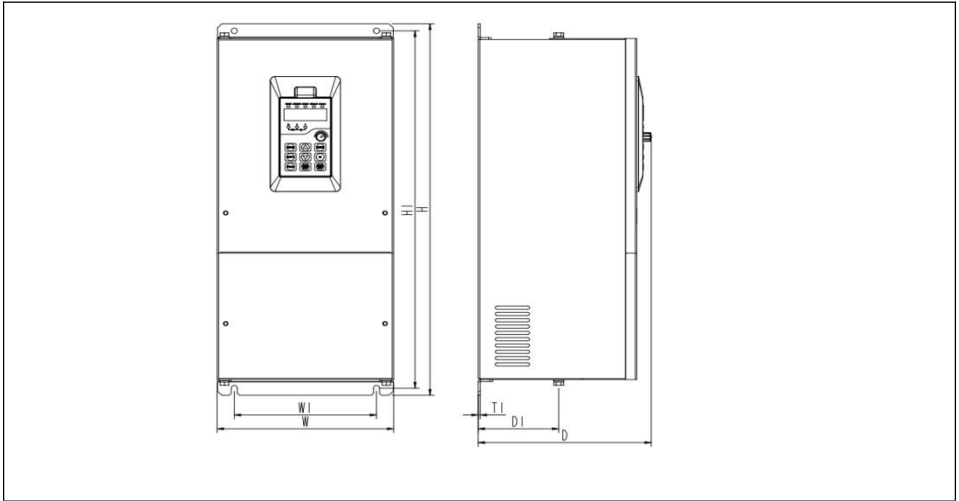

Figure 2-3 KC200-4T/5T-0055G~KC200-4T/5T-0560G

Table 2-3 Mechanical parameters

AC drive type G: constant torque load	Profile and mounting size (mm)							Approximate weight (Gross weight, kg)
	W	H	D	W1	H1	D1	Mounting hole d	
KC200-2S-0R40G	126	186	167	115	175	78	4.7	2
KC200-2S-0R75G								
KC200-2S-01R5G								
KC200-2S-02R2G								
KC200-4T/5T-0R75G								
KC200-4T/5T-01R5G								
KC200-4T/5T-02R2G								
KC200-4T/5T-03R7G								
KC200-4T/5T-05R5G	146	256	181	131	243	95	6	6
KC200-4T/5T-07R5G								
KC200-4T/5T-0011G								
KC200-4T/5T-0015G	170	320	207	151	303	118.5	5.8	8
KC200-4T/5T-0018G								
KC200-4T/5T-0022G								
KC200-4T/5T-0030G	225	360	234	206	342	130	6.5	9
KC200-4T/5T-0037G								
KC200-4T/5T-0045G								

AC drive type G: constant torque load	Profile and mounting size (mm)							Approximate weight (Gross weight, kg)
	W	H	D	W1	H1	D1	Mounting hole d	
KC200-4T/5T-0055G	285	617	258	220	596	132	10	35
KC200-4T/5T-0075G								
KC200-4T/5T-0090G	320	639	317	240	620	152	11	60
KC200-4T/5T-0110G								
KC200-4T/5T-0132G								
KC200-4T/5T-0160G	530	940	385	340	910	206	14	114
KC200-4T/5T-0185G								
KC200-4T/5T-0200G								
KC200-4T/5T-0220G	690	1006	380	500	974	207	14	156
KC200-4T/5T-0250G								
KC200-4T/5T-0280G								
KC200-4T/5T-0315G	810	1228	400	520	1196	209	14	225
KC200-4T/5T-0355G								
KC200-4T/5T-0400G								
KC200-4T/5T-0450G	810	1328	401.5	520	1296	209	14	225
KC200-4T/5T-0500G								
KC200-4T/5T-0560G								

2.6.2 Dimensions of the operation Panel and installation box

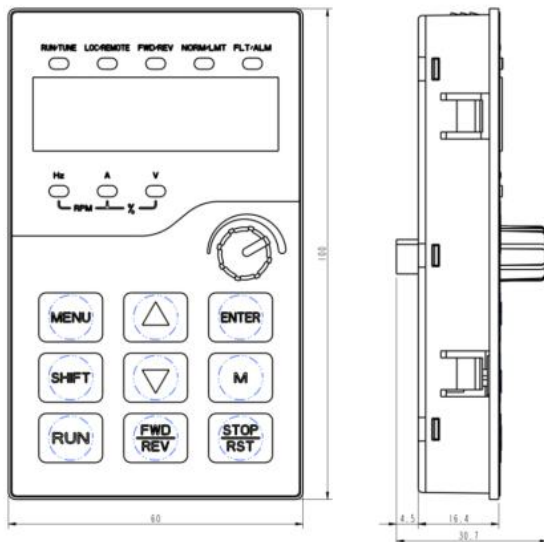

Figure 2-4 Dimensions of the operation panel

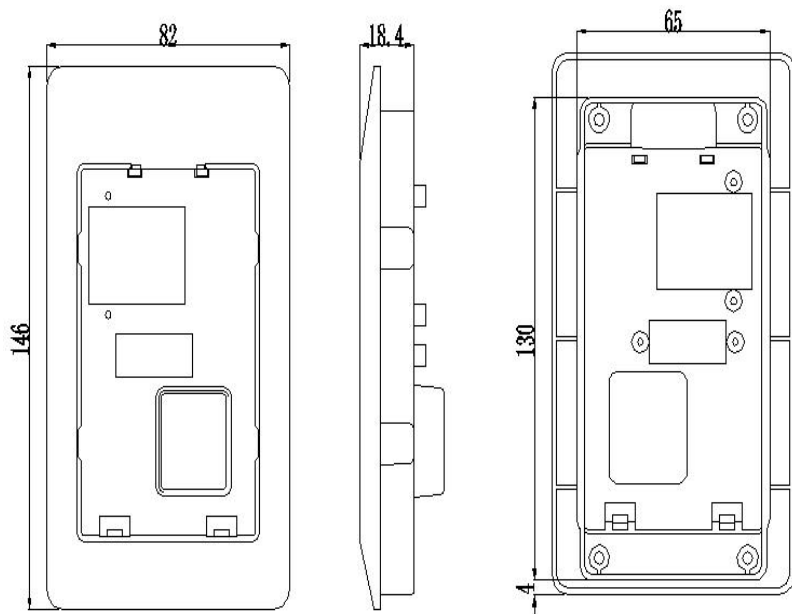

Figure 2-5 Dimensions of the installation box

Note: When the operation panel is mounted, the opening size of the tray is 65*130mm.
 Select external keyboard ,see **chapter 9.4!**

2.7 Installation requirements

It should be installed indoors in a well-ventilated place and should generally be installed vertically.

When choosing an installation environment, you should pay attention to the following:

- The ambient temperature is required to be within the range of -10°C~40°C. If the temperature exceeds 40°C, external forced cooling or derating is required;
- The humidity requirement is less than 95%, and there is no condensation of water droplets;
- Installed in places where the vibration is less than 5.9 meters/second² (0.6g);
- Avoid installing in places exposed to direct sunlight;
- Avoid installing in dusty and metal powder places;
- It is strictly prohibited to install in places with corrosive and explosive gases.

If you have special installation requirements, please consult and confirm in advance.

The installation intervals and distance requirements are shown in Figure 2-6 and Figure 2-7.

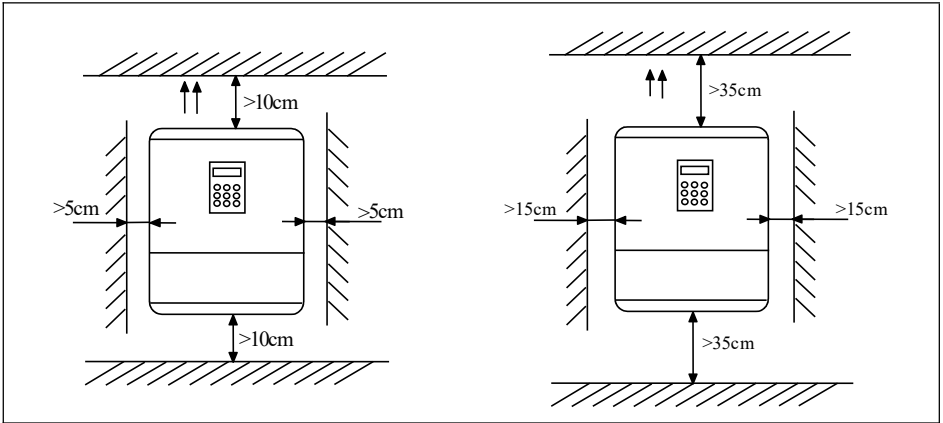

Figure 2-6 Installation separation distance (0045G and below)

Figure 2-7 Installation separation distance (0055G and above)

When two AC drives are installed up and down, use a baffle plate in the middle, as shown in Figure 2-8.

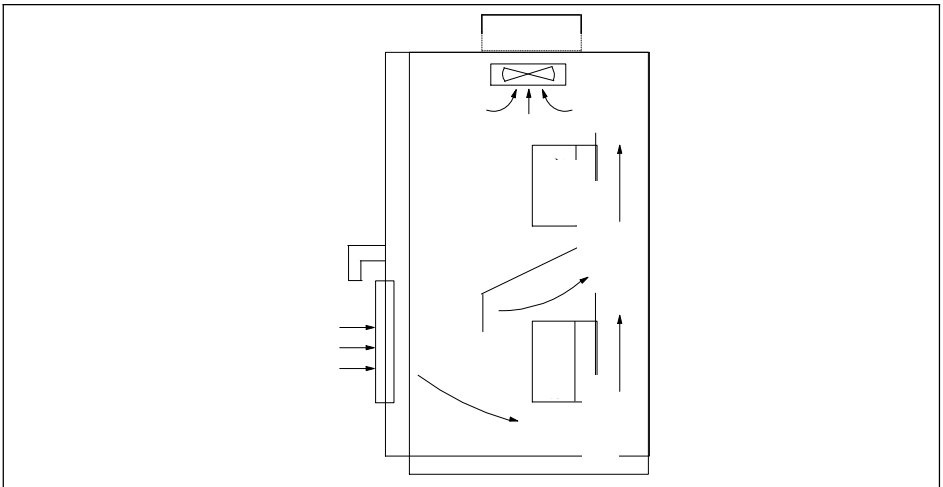

Figure 2-8 Installation of multiple AC drives

3 System interface and wiring

3.1 Electrical wiring diagram

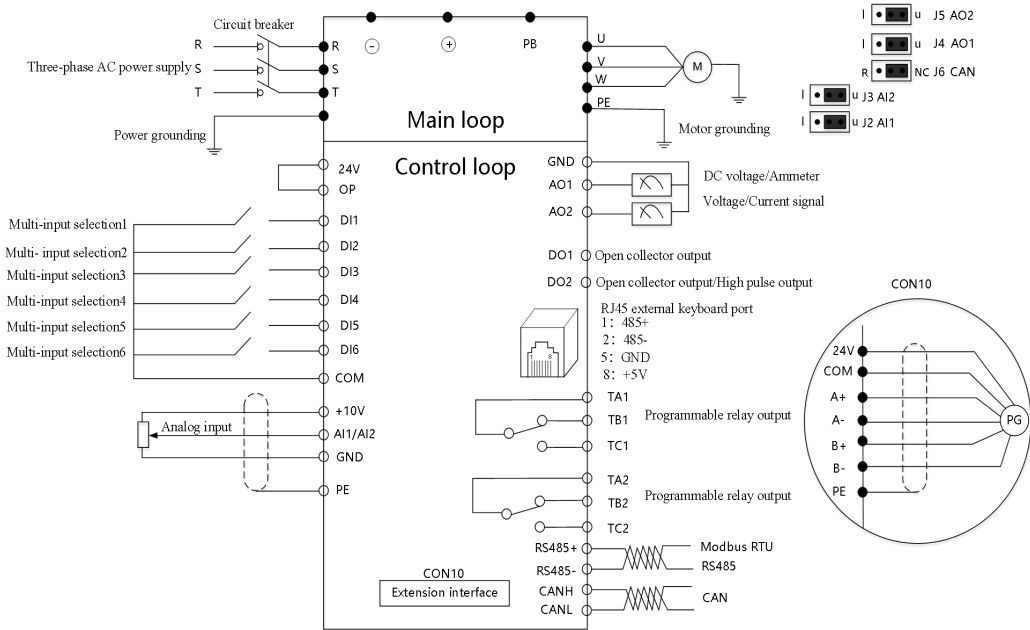

Figure 3-1 AC drive basic wiring connection diagram

Danger!

- Only after reliably cutting off the power supply to the AC drive and waiting for at least 10 minutes can you open the AC drive cover.
- Only when the voltage value between the main circuit terminals (+) and (-) is below DC36V, can the internal wiring work be started.
- The internal wiring work of the frequency converter can only be performed by trained and authorized qualified professionals.
- When connecting an emergency stop or safety circuit, carefully check its wiring before and after operation.
- Please check the voltage level of the AC drive before powering on, otherwise it may cause casualties and equipment damage.



Note!

- Before use, it is necessary to carefully verify whether the rated input voltage of the AC drive is consistent with the voltage of the AC power supply.
- The AC drive has passed the withstand voltage test before leaving the factory. Users are not allowed to perform the withstand voltage test on the AC drive.
- When an external braking resistor or braking unit is required, please refer to Chapter 2.
- Do not connect the power cable to U, V, and W.
- The ground cable must be copper with a diameter larger than 3.5mm and a ground resistance smaller than 10 Ω.
- There is a leakage current in the AC drive. The specific value of the leakage current is determined by the use conditions. To ensure safety, the AC drive and motor must be grounded, and the user must be installed in the power leakage protector (that is, RCD). The current setting value is 300mA.
- In order to provide input side overcurrent protection and outage maintenance convenience, the AC drive should be connected to the power supply through an air switch or a fuse switch

3.2 Peripheral system configuration

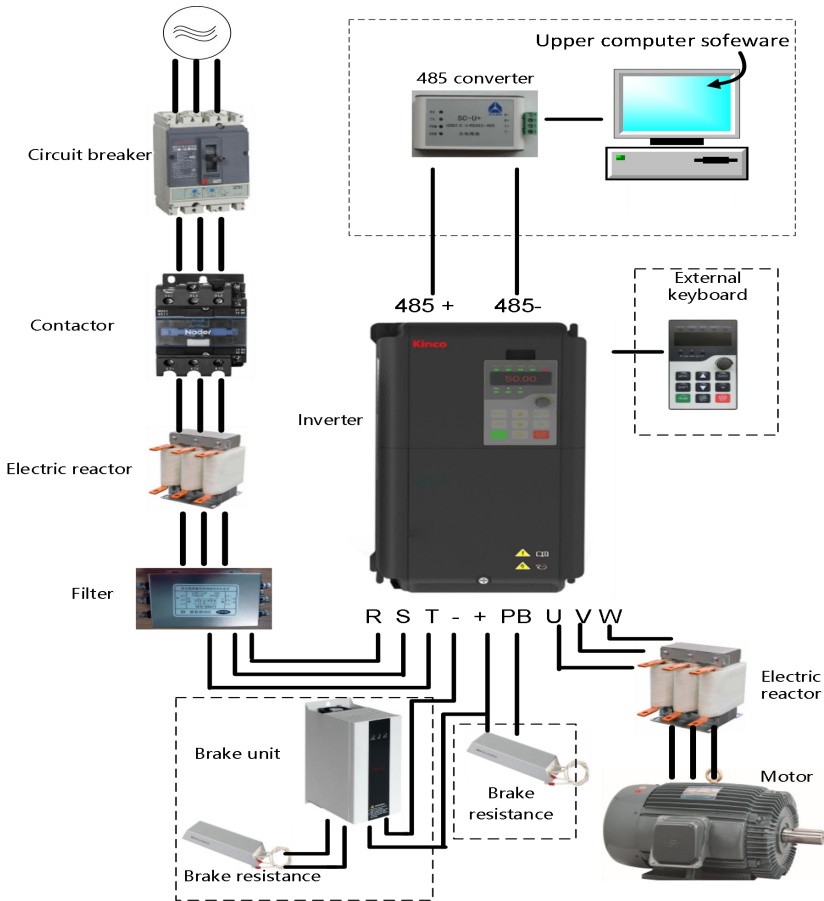

Figure 3-2 System peripheral configuration diagram

Table 3-1 Peripheral electrical configuration description

Name	Description
Circuit breaker or leakage protector	The capacity of the circuit breaker is generally selected based on 1.5 to 2 times the rated current of the AC drive. Since the output voltage of the frequency converter is PWM high-frequency pulse voltage, leakage current is inevitable. It is recommended to choose a B-type special leakage protector.
Contactor	It is easy to control, but frequent opening and closing of the contactor will cause the AC drive to malfunction.
Input AC reactor or DC reactor	Improve the impact of power factor and three-phase unbalance on the system Suppress the impact of peak current on the input terminal of the AC drive Reduce external interference
Input filter	Improve the anti-interference ability of AC drive and reduce the external interference of AC drive

Name	Description
Output AC reactor	When the cable from the AC drive to the motor exceeds 100 meters, it is recommended to install an AC reactor to suppress harmonic voltage and reduce leakage current.
Braking unit and braking resistor	Consume the energy fed back by the motor to achieve rapid braking

3.2.1 Main circuit terminal wiring and configuration

3.2.1.1 Main loop input/output terminal type

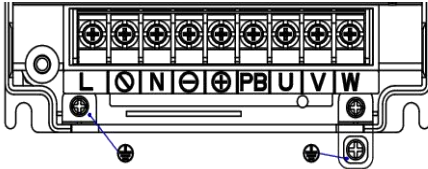

Applicable models: KC200-2S-0R40G~KC200-2S-02R2G

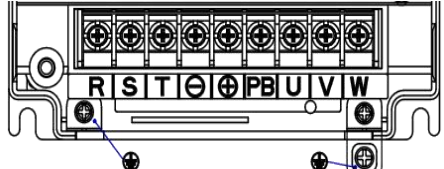

Applicable models: KC200-4T/5T-0R75G~KC200-4T/5T-03R7G

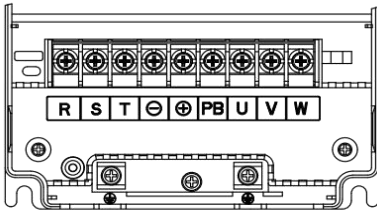

Applicable models: KC200-4T/5T-05R5G~KC200-4T/5T-0022G

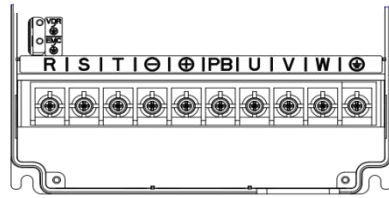

Applicable models: : KC200-4T/5T-0030G~KC200-4T/5T-0045G

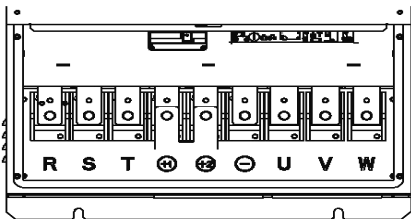

Applicable models: KC200-4T/5T-0055G~KC200-4T/5T-0560G

Table 3-2 Main circuit terminal function description

Terminal name	Function Description
R、S、T	Three-phase 380V/Three-phase 440V input terminal
L、N	Single-phase 220V input terminal
-	DC negative bus output terminal
+1 +2	Reserved terminals for external DC reactor
+2 -	External braking unit terminals
+ PB	Access terminal of braking resistor

U、V、W	Three-phase AC output terminal
	Shield ground terminal

3.2.1.2 AC drive main circuit wiring method

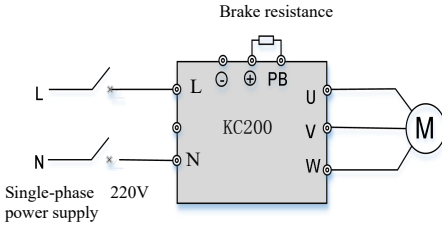

KC200-2S-0R40G~KC200-2S-02R2G

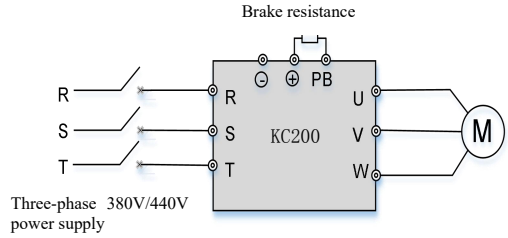

KC200-4T/5T-0R75G~KC200-4T/5T-0045G

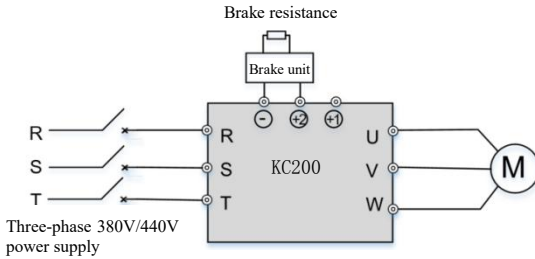

KC200-4T/5T-0055G~KC200-4T/5T-0560G

3.2.2 Control circuit terminal wiring and configuration

3.2.2.1 Wiring of control loop terminals

Before putting the AC drive into use, the terminal wiring should be performed correctly. Please refer to Table 3-3 for the function description of the control loop terminals.

Table 3-3 Control loop terminal function

Serial number	Function
1	Analog input and output ports, switching input and output ports, RS485 communication port, CAN communication port, relay output port

Note

It is recommended to use wires of 1mm² or more as the connection wires of the control loop terminals.

Control loop terminal arrangement is shown as follows:

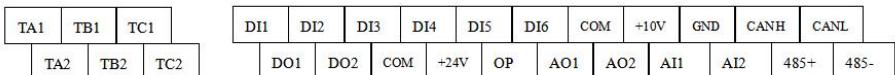



Figure 3-3 Control terminal arrangement diagram

Please refer to Table 3-4 for the function description of each terminal.

Table 3-4 Interface board terminal CNA function table

Category	Terminal silk screen	Name	Terminal function description	Specification
Shield		Shield ground	Used for terminal wiring shield grounding. The shielding layers of analog signal lines, 485/CAN communication lines, and motor cables can be connected to this terminal.	Internally connected to the main circuit terminal PE
Power supply	+10V	+10V power supply	Reference ground for analog signals and +10V power supply	The maximum allowable output current is 10mA
	GND	+10V power ground	Reference ground for analog signals and +10V power supply	Internally isolated from COM
Simulate input	AI1	Analog single-ended input AI1	Accepts single-ended input of analog voltage or current. The voltage/current input is selected by jumper AI1 on the control board (reference ground: GND)	12-bit resolution Input voltage/current range: 0 ~ 10V/0 ~ 20mA Input impedance at voltage input: 20k Ω Input impedance for current input: 500 Ω
	AI2	Analog single-ended input AI2	Accepts single-ended input of analog voltage or current. The voltage/current input is selected by jumper AI2 on the control board (reference ground: GND)	
Simulate output	AO1	Analog output 1	Provides analog voltage/current output. The output voltage and current are selected by jumper AO1 on the control board. The factory default output voltage is shown in the description of function code F11.00 (reference ground: GND).	Voltage output range: 0~10V Current output range: 0/4~20mA
	AO2	Analog output 2	Provides analog voltage/current output. The output voltage and current are selected by jumper AO2 on the control board. The factory default output voltage is shown in the description of function code F11.01 (reference ground: GND).	Voltage output range: 0~10V Current output range: 0/4~20mA
Communication	RS485+	RS485 communication interface	485 differential signal positive terminal	Standard RS485 communication interface Use twisted pair or shielded twisted pair
	RS485-		485 differential signal negative terminal	
	CANH	CAN communication interface	CAN high level terminal	Use twisted pair or shielded twisted pair
	CANL		CAN low level terminal	

Category	Terminal silk screen	Name	Terminal function description	Specification
Multifunction input terminal	DI1	Multifunction input terminal 1	DI1~DI6 can be programmably defined as switching input terminals with multiple functions. DI6 can also be used as a high-speed pulse input terminal. For details, see function parameters F08.00~F08.05.	Compatible with bipolar input, support NPN and PNP connection, active level input voltage range: 9V~30V DI-DI5 is a low-speed input with an input impedance of 4.7k Ω and a maximum input frequency of 200Hz DI6 as a high-speed input, input impedance 2.2k Ω , maximum input frequency 100kHz
	DI2	Multifunction input terminal 2		
	DI3	Multifunction input terminal 3		
	DI4	Multifunction input terminal 4		
	DI5	Multifunction input terminal 5		
	DI6	Multifunction input terminal 6		
Multifunction Output terminal	DO1	Open collector Output terminal	It is programmable and defined as a switching output terminal with multiple functions. For details, see function parameter F10.00 (common terminal: COM)	Maximum working voltage: 30V Maximum output current: 50mA
	DO2	High speed pulse output terminal	Can be used as high-speed pulse output terminal; It can also be used as an open collector output terminal, see functional parameter F11.02 (common end: COM)	High-speed pulse output maximum frequency 100kHz;
Power supply	+24V	+24V Power supply	Provides external +24V power supply, which can be used as working power supply for digital input and output terminals and external sensor power supply.	Maximum output current: 200mA
Common terminal	OP	Multifunction input common end	The factory default is short-circuited with +24V. When using external signals to drive DI1~DI6, the OP needs to be connected to the external power supply and disconnected from the +24V power terminal.	Common terminal of DI1~DI6
	COM	24V power supply common end	There are 2 common terminals in total, used in conjunction with other terminals	COM and GND are internally isolated

Category	Terminal silk screen	Name	Terminal function description	Specification
Relay output terminals (2 sets)	TA1/TB1/TC1 TA2/TB2/TC2	Relay output	Programmable relay output terminals defined as multiple functions, see function parameter F10.02 for details	TA1-TB1,TA2-TB2: normally closed, TA1-TC1,TA2-TC2: normally open, contact capacity: AC 250V/3A DC 30V/1A

3.2.2.2 Analog input terminal wiring

AI1 and AI2 terminals accept single-ended input of analog voltage or current. The voltage/current input is selected by jumpers AI1 and AI2 on the control board. The wiring method is as follows:

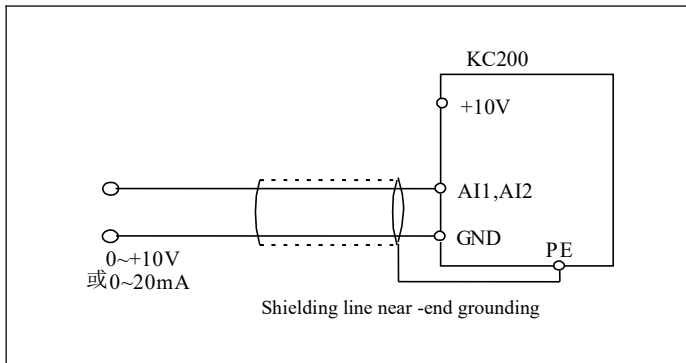

Figure 3-4 AI1/AI2 terminal configuration diagram

3.2.2.3 Analog output terminal wiring

Analog output terminals AO1 and AO2 can be connected to external analog meters to indicate a variety of physical quantities. Select the output 0~10V or 0~20mA through the control board jumpers AO1 and AO2. The terminal wiring method is as follows:

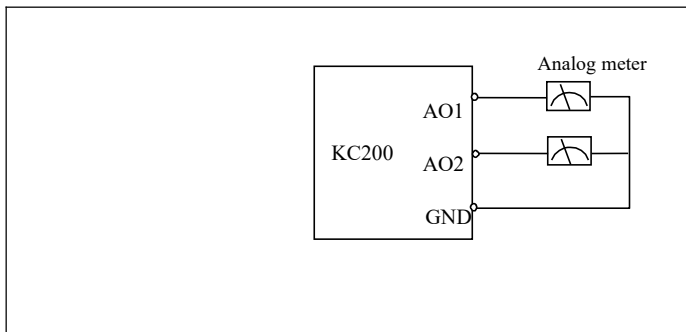

Figure 3-5 Analog output terminal wiring

Note:

1. When using analog inputs, a filter capacitor or common-mode inductor can be installed between the input signal and GND.
2. It is recommended that the voltage of the analog input signal not exceed 15V.
3. Analog input and output signals are susceptible to external interference. Shielded cables must be used during wiring and must be well grounded. The wiring length should be as short as possible.
4. The analog output terminal can withstand a maximum voltage of 15V.

3.2.2.4 Multi-function input terminal and operation control terminal wiring

The KC200 multi-function input terminal uses a full-bridge rectifier circuit, as shown in Figure 3-6. OP is the common terminal of DI1~DI6. The current flowing through the PLC terminal can be a source current or a sink current. The external interface between DI1~DI6 is very flexible. The typical wiring method is as follows:

1. Dry contact method

1) Use the 24V power supply inside the AC drive, and the wiring method is as shown in Figure 3-6.

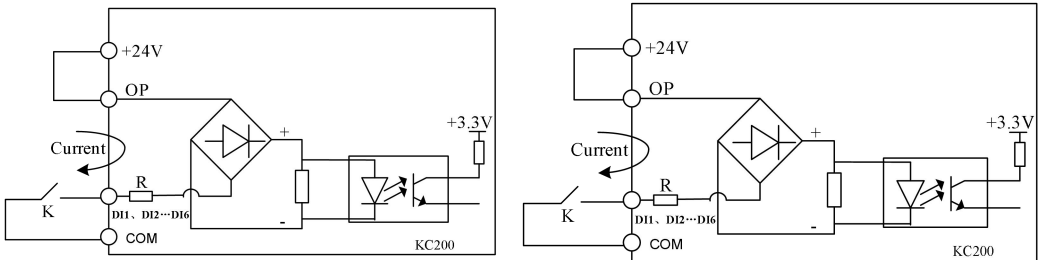

Figure 3-6 The connection method of using the internal 24V power supply

2) Use an external power supply (the power supply must meet the UL CLASS 2 standard, and a 4A fuse needs to be added to the power supply and interface). The wiring method is as shown in Figure 3-7 (note that the connecting wire between the OP and the 24V terminal is removed).

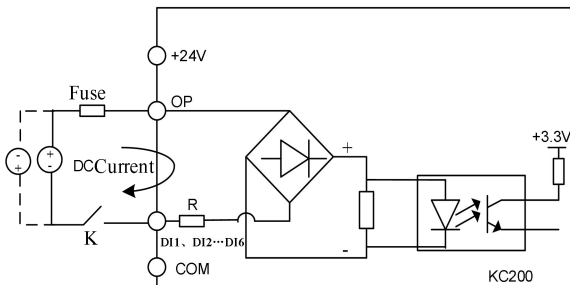

Figure 3-7 Use the connection method of external power supply

2. Source (drain) method

1) Use the internal +24V power supply of the AC drive, and the external controller is an NPN type common emitter output connection method, as shown in Figure 3-8.

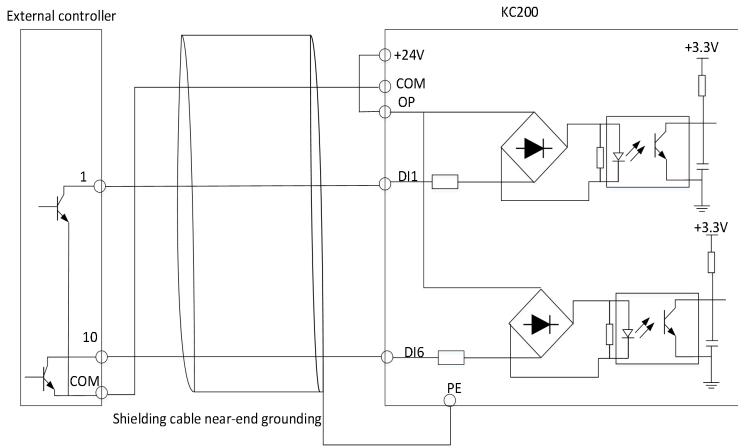

Figure 3-8 Source connection of the +24V power supply in the AC drive

2) Use the internal +24V power supply of the AC drive, and the external controller is a PNP type common emitter output connection method (note that the connection line between the OP and the 24V terminal is removed), as shown in Figure 3-9.

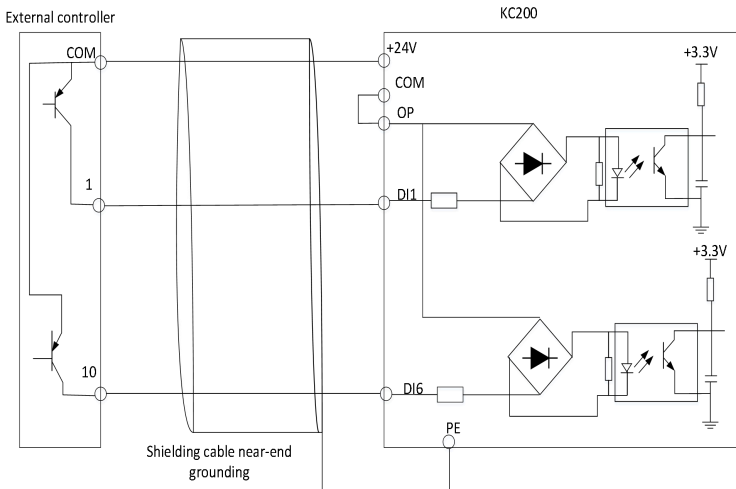

Figure 3-9 Drain connection of the +24V power supply inside the AC drive

3) Use the source connection method of external power supply: (be careful to remove the connection line between OP and 24V terminal)

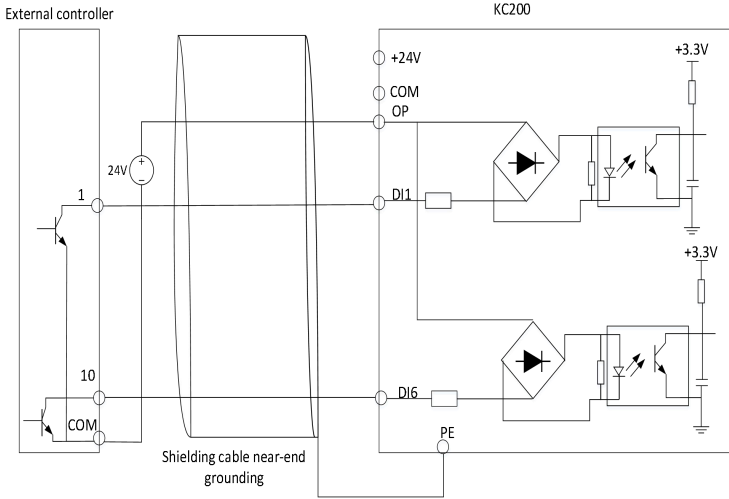

Figure 3-10 Source connection of an external power supply

4) Use the drain connection method of the external power supply (note that the connection line between the OP and the 24V terminal is removed)

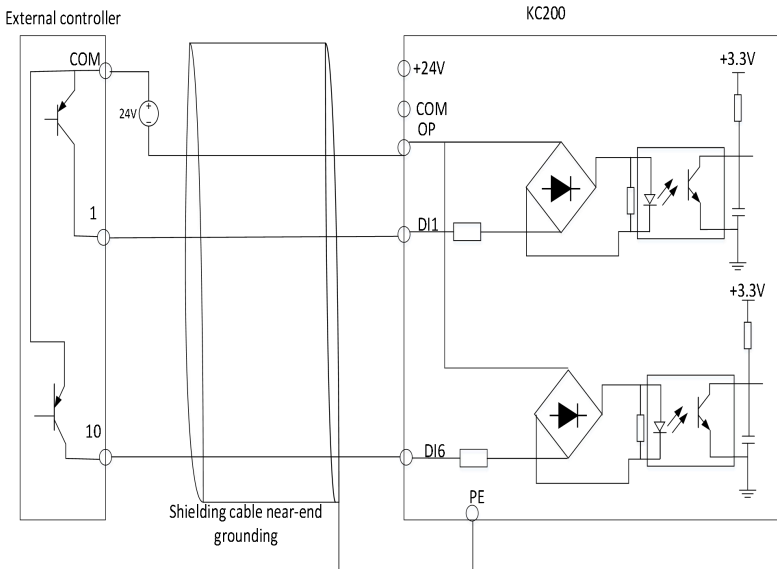

Figure 3-11 Drain connection of an external power supply

3.2.2.5 Multi-Function Output Terminal Wiring

1. The multi-function output terminal DO1 can use the 24V power supply inside the AC drive. Please refer to Figure 3-12 for the wiring method.1.

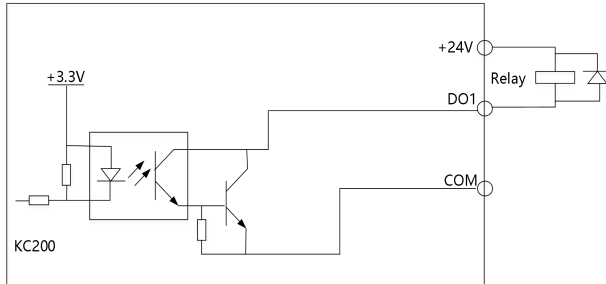

Figure 3-12 Multi-function output terminal wiring method 1

2. The multi-function output terminal DO1 can also use an external power supply. Please refer to Figure 3-13 for the wiring method.

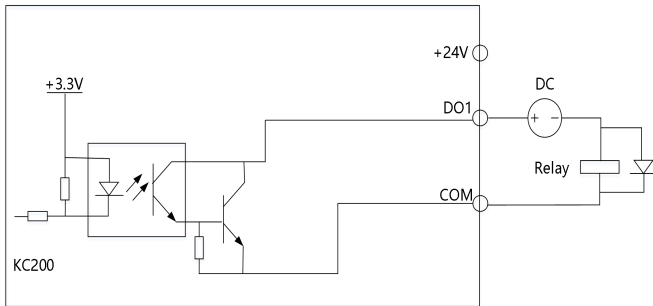

Figure 3-13 Multi-function output terminal wiring method 2

3. DO2 is used as digital pulse frequency output and can use the 24V power supply inside the AC drive. For the wiring method, please see Figure 3-14.

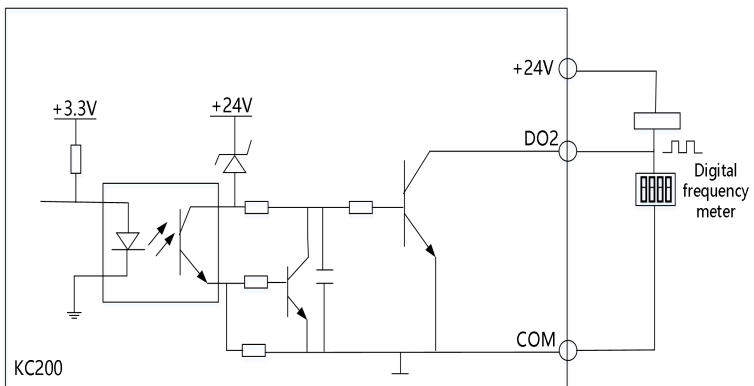

Figure 3-14 Output terminal DO2 connection mode 1

4. DO2 is used as digital pulse frequency output, and an external power supply can also be used. Please see Figure 3-15 for the wiring method.

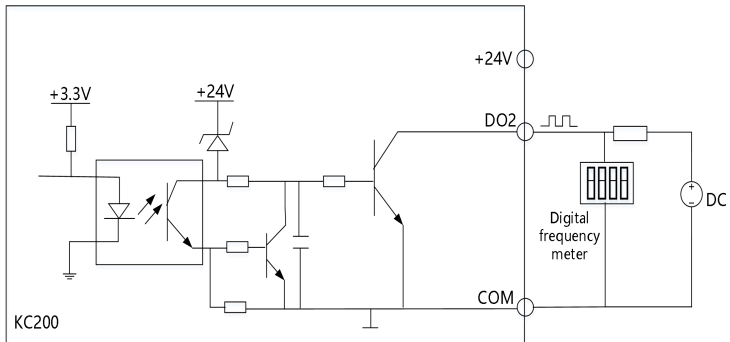

Figure 3-15 Output terminal DO2 connection mode 2

3.2.2.6 Relay output terminal (TA1-TB1-TC1, TA2-TB2-TC2) wiring

If you drive an inductive load (such as an electromagnetic relay, contactor), a surge voltage absorption circuit should be installed; such as: RC absorption circuit (note that its leakage current should be less than the holding current of the controlled contactor or relay), varistor, Or freewheeling diode, etc. (used in DC electromagnetic circuit, be sure to pay attention to the polarity when installing). The components of the absorption circuit should be installed nearby at both ends of the coil of the relay or contactor.

Notice

1. Do not short-circuit the 24V terminal and COM terminal, otherwise the control board may be damaged.
2. Please use multi-core shielded cables or stranded wires (1mm 2 or more) to connect the control terminals.
3. When using a shielded cable, the near end of the cable shield (the end close to the AC drive) should be connected to the ground terminal PE of the AC drive.
4. When wiring, control cables should be kept at least 20cm away from the main circuit and strong current lines (including power lines, motor lines, relay lines, contactor connection lines, etc.)

Avoid parallel placement, and it is recommended to use vertical wiring to prevent the AC drive from malfunctioning due to interference.

5. In Figure 3-12 and Figure 3-13, for non-24V relays, appropriate resistors should be selected according to the relay parameters and connected in series in the relay circuit.

6. The digital output terminal cannot withstand voltages exceeding 30V.

4 Operation panel layout and operating instructions

4.1 Operation panel layout

4.1.1 Appearance and key function description of the operation panel

The operation panel is the main unit for the AC drive to accept commands and display parameters. It is LED type. The LED type operation panel is shown in Figure 4-1.

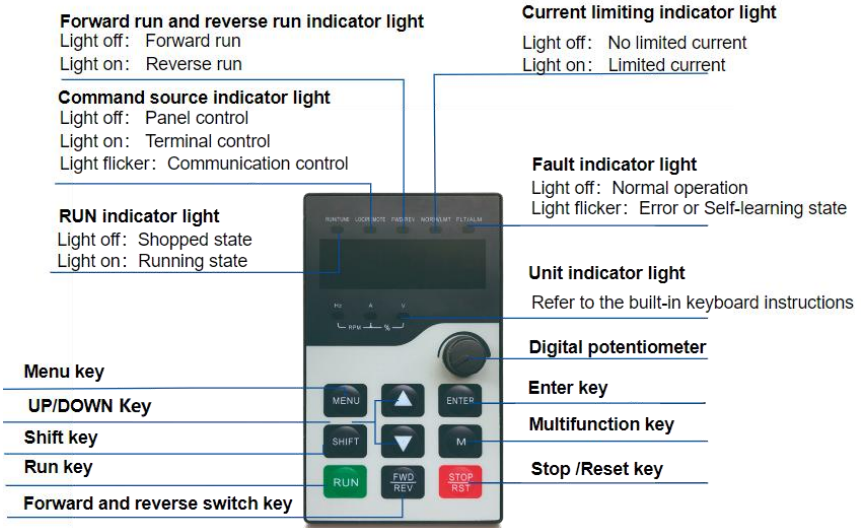











Figure 4-1 LED operation panel

There are 9 buttons on the AC drive operation panel, and the function definition of each button is shown in Table 4-1.

表 4-1 LED keyboard key function introduction

LED key board	Function
Digital potentiometer 	Clockwise rotation increases the operating value, counterclockwise rotation decreases the operating value.
Menu key 	Enter the function menu interface when standby or running; When the parameter is in the modified state, press the key to exit the modification.
Shift key 	Standby or running switch display stop display parameter or running display parameter, you can view the definition by F15.10-F15.19; Press this key to shift to change the digit to the right when the parameter is changing status.
UP、DOWN key 	UP,DOWN operation bits.
Run key 	When run/stop is controlled by the keyboard, press this key to run the AC drive and the motor is forward.
	When the command given channel is keyboard control, press the key to stop the AC drive; Other command channels can be defined by parameter F15.01 whether they are valid; Fault state Press the key to reset the AC drive.
 Multifunction key	Select the function of this key by parameter F15.00[Keyboard Multifunction Key Selection].
 Enter key	Press this key after changing the value to confirm the change.
 FWD/REV key	Use this key to control the motor to rotate forward and reverse

4.1.1.1 Status indicator light











In the following table, the indicator  is on, the indicator  is off, and the indicator  is blinking.

Table 4-2 Operation panel indicator light description

Indicator status		Status instructions
RUN/TUNE Run indicator		Off: Shutdown state
		On: Running status
LOC/REMOTE Command source indicator		Off: Keyboard panel control
		On: Terminal control
		Blinking: Communication control
FWD/REV Forward and reverse indicator		Off: Forward running
		On: Reverse operation

NORM/LMT Current limit indicator		Off: No current limit	
		On: Current limiting state	
FLT/ALM Fault indicator		Off: No fault	
		On: Torque control status	
		Blinking: The AC drive is faulty or in the self-learning state	
Hz A V	Frequency Hz display	Hz A V	Voltage display
Hz A V	Current A display	Hz A V	RPM display
Hz A V	Percent % display		

4.1.1.2 Data display

The operation panel has a total of 5 digits LED data display, which can display the set frequency, output frequency, various monitoring data and alarm code.

Table 4-3 LED data display and actual data corresponding table

LED Display	Actual correspondence	LED display	Actual correspondence	LED display	Actual correspondence	LED display	Actual correspondence
	0		9		H		P
	1		A		h		q
	2		b		I		r
	3		C		J		T
	4		c		k		t
	5/S		d		L		U
	6		E		N		u/v
	7		F		n		y



Table 4-4 Special LED status display on the operation panel

LED Display	Meaning	LED Display	Meaning
	Restore factory parameters		Download keyboard parameters to the control board
	Control board parameters are uploaded to the key board		EST: Parameter tuning process The last two digits of the nixie tube change the number with the tuning step

4.2 Menu description

The operation panel adopts the 3-level menu structure for parameter setting and other operations. After entering the menu of each level, when the display bit flashes, you can press the UP key, DOWN key, SHIFT key to set.

The three level menus are as follows: Level-1 menu: Parameter group; Level-2 menu: Parameter; Level-3 menu: parameter Settings and the initial monitoring interface.

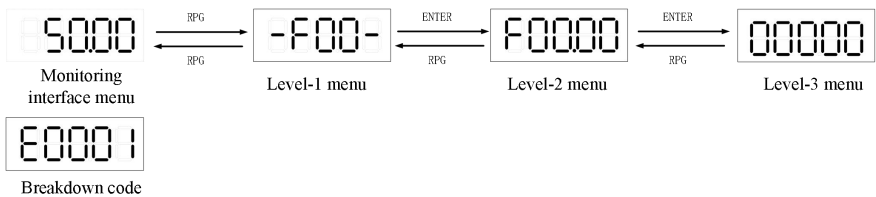

Figure 4-3 Operation hierarchy diagram of the standard menu

When the AC drive menu mode selects the check menu, the LED panel only displays parameters different from the factory value, that is, there is no first-level menu.



Figure 4-4 Operation hierarchy diagram of level of verify menu

Table 4-5 Menu mode selection parameters

Parameter Code (address)	Name	Content	Parameter Description
F00.02 (0x0002)	Menu Mode selection	0: Standard menu 1: Verify menu	0: Standard menu ,Displays all parameters. 1: Verify menu , Display parameters that differ from the factory values.

4.3 Status parameter display

When in the monitoring interface menu, you can switch by the keyboard SHIFT key to display the running shutdown parameters.

In the running state, you can view the running state parameters by holding down SHIFT key. The default

display status parameters are: operating frequency, given frequency, output current, output voltage, bus voltage.

In the shutdown state, you can view the status parameters by holding down SHIFT key. The default display status parameters are: set frequency, bus voltage, AI voltage, keyboard potentiometer voltage.

If you want to view other status parameters, please refer to the following running shutdown parameter display Settings.

Table 4-6 LED running display parameters

Parameter code (address)	Name	Content	参数说明
F15.10 (0x0F0A)	LED display 1 in running state	0: Disabled	In the running or shutdown state, press the SHIFT key on the keyboard operation panel to view the status value of up to 5 running display parameters of the AC drive in real time.
F15.11 (0x0F0B)	LED display 2 in running state	1: Main frequency X 2: Auxiliary frequency Y 3: Setting frequency (after acceleration and deceleration)	
F15.12 (0x0F0C)	LED display 3 in running state	4: Reference frequency (target value) 5: Running frequency 6: Output voltage	
F15.13 (0x0F0D)	LED display 4 in running state	7: Output current 8: DC-Bus voltage 9: Setting torque 10: Output torque	
F15.14 (0x0F0E)	LED display 5 in running state	11: Output power 12: Setting speed 13: Running speed	
F15.15 (0x0F0F)	LED display 1 in stop state	14: AC drive operating status 15: AC drive temperature 16: Motor temperature 17: DI state 18: DO state	
F15.16 (0x0F10)	LED display 2 in stop state	19: AI voltage before correction 20: AI voltage 25: Operating panel potentiometer voltage before correction 26: Operating panel potentiometer voltage	
F15.17 (0x0F11)	LED display 3 in stop state	27: AO output 29: Input PULSE frequency (0.01KHz) 30: Output PULSE frequency(0.01KHz) 31: V/f separation target voltage 32: V/f separation output voltage	
F15.18 (0x0F12)	LED display 4 in stop state	33: Communication setpoint 34: PID reference 35: PID feedback 36: PID error	
F15.19 (0x0F13)	LED display 5 in stop state	37: PID integral value 38: PID output 40: Count value 45: Power factor angle 46: Motor speed feedback 48: Load speed	

		57: Remaining running time 58: Current power-on duration 59: Current running duration 60: High-order bits of accumulative power consumption 61: Low-order bits of ccumulative power consumption 62: High-order bits of current power consumption 63: Low-order bits of current power consumption	
--	--	--	--

4.4 Parameter setting

Application examples:

Change the parameter keypad number given frequency F01.10 from 50.00Hz to 15.00Hz.

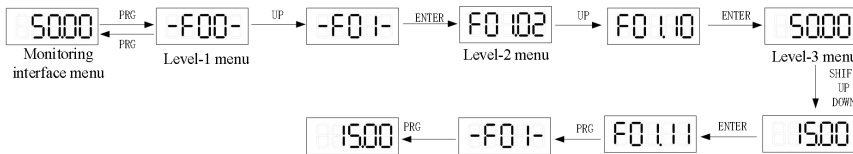

Figure 4-5 Schematic diagram of changing the operating frequency

During the level-3 menu operation, you can press the PRG key or ENTER key to return to the Level-2 menu. The difference between the two is:

1. Press ENTER key to save the setting parameter and return to the secondary menu, and automatically move to the next parameter;
2. Press PRG key to abandon the current parameter modification and directly return to the upper-level menu corresponding to the current parameter.

In the third level menu state, if the parameter setting value does not blink, it means that the parameter value cannot be set. The possible reasons are as follows:

1. The parameter is an unchangeable parameter;
2. The AC drive is in the running state, the parameter cannot be changed in the running state, and can be changed only after stopping;
3. The user password is currently set.

4.5 M Multifunction Key Operation

The M key on the operation panel is a Multi-function key, and the function of the Multi-function key can be set by parameter F15.00. In the shutdown or running state, press this key to switch the command channel, forward and reverse operation, and forward and reverse click operation.

Table 4-7 Function key selection parameters

Parameter code (address)	Name	content	Parameter Description
F15.00 (0x0F00)	Multi-function key	0: Multi-function key disabled 1: Switch between operating panel command channel and remote command channel (terminal command channel or communication command channel) 2: Forward and reverse switching 3: Forward jog 4: Reverse jog	The M key on the operation panel is a Multi-function key, and the function of M key is set by this parameter. 0: The M key is invalid This key is not functional. 1: Switch between the command channel of the operation panel and the remote command channel (terminal command channel or communication command channel) F01.03 Set to 0(Operation panel), no effect after pressing M key; F01.03 is set to 1(Terminal), and the switch between terminal and operation panel can be realized by M key; F01.03 is set to 2(Communication), and the switch between communication and operation panel can be realized by M key. 2: Forward and reverse switch Use the M key to switch the direction of the frequency command. This feature only works if the run command channel is the Operations panel. 3: Forward turn click Positive turn point motion (FJOG) is achieved through the M key. This feature only works when the run command channel is the operation panel. 4: Reverse the tap Reverse dotting via the M key (RJOG) This feature only works when the run command channel is the operation panel.

4.6 Operation panel drive motor

Press the RUN and STOP/RST keys on the operation panel to start and stop the motor.

Operation steps:

1. Check before power-on;

Check the installation and wiring according to the installation manual. For detailed checks, refer to the

Pre-power-on check in the Installation Guide.

2. Press the power switch to switch on the AC drive power supply;
3. Check the display 50.00 on the operation panel, indicating successful power-on;



Figure 4-6 Frequency converter power-on display

4. Press the RUN key to start the motor, and the motor shaft starts to accelerate and rotate. At the same time, the panel displays the current running frequency, as shown in the picture below. After the acceleration is completed, the frequency value is displayed as 50.00. Hold down the SHIFT key to switch the running state parameters displayed;



Figure 4-7 Steady operation of the frequency converter

5. Press the STOP key to slow down the motor and stop the machine.

5 Function introduction

5.1 Operation command setting

5.1.1 Run command channel setting

Operation commands are used to control the start, stop, forward run, reverse run, and jog operations of the AC drive. Three command sources are available: operating panel, terminal I/O, and communication.

You can select the operation command source by setting F01.03.

Table 5-1 Operation command source parameter

Parameter code (address)	Name	Content	Default (Value Range)	参数说明
F01.03 (0x0103)	Operation command source	0:Operating panel control 1: Terminal I/O control 2: Communication control	0 (0~2)	Select the input channel for the AC drive control command. AC drive control commands include: start, stop, forward, reverse, point and so on. 0: Operating panel control Control commands are input using the RUN, STOP/RES, and M keys on the operating panel. This mode is suitable for initial commissioning. 1: Terminal I/O control Control commands are input through the DI terminals of the AC drive. The DI terminal control commands can be set based on different scenarios, such as start/stop, forward/reverse run, jog, two-wire/threewire control, and multi-speed. It is suitable for most applications. 2: Communication control Control commands are input through remote communication. This mode applies to remote control or centralized control of multiple equipment.

5.1.2 Operating panel control

When F01.03 is set to 0, the start and stop of the AC drive are controlled by pressing keys (RUN and STOP/RES) on the operating panel.

When you press RUN, the AC drive starts to run (the RUN indicator is on).

When you press STOP/RES during running, the AC drive stops running (the RUN indicator is off).

5.1.3 Terminal I/O control

1. When F01.03 is set to 1, operation command sources select Terminal I/O Control.

2. When F08.00 is set to 1 (forward run) or set to 2 (reverse run), the start and stop of the AC drive are controlled through terminals.

3. DI is assigned with the Three-wire operation control function, and You can set F08.10 to select a terminal control mode.

Four terminal I/O control modes are available,

including two-wire mode 1, two-wire mode 2, three-wire mode 1, and three-wire mode 2.

Table 5-2 Terminal control mode parameter

Parameter code (address)	Name	Content	Default (Value Range)	Description
F08.10 (0x080A)	Terminal control mode	0: two-wire mode 1 1: two-wire mode 2 2: three-wire mode 1 3: three-wire mode 2	0 (0~3)	This parameter defines the mode in which the AC drive is controlled by external terminals.

The multi-function input terminals of DI1 to DI6 can be selected as external input terminals. That is, you can set F08.00 to F08.03 to select the functions of DI1 to DI6 input terminals. For details about the functions, see F08.00(DI1) to F08.06(DI4) in 7.2 Parameter Overview.

Application examples:

The DI1 terminal is assigned the forward operation function, and the DI2 terminal is assigned the reverse operation function. Connect the forward running switch to DI1 terminal and the reverse running switch to DI2 terminal.

Table 5-3 DI1 set to FWD, DI2 set to REV parameter

Parameter	Name	Reference	Function Description
F08.10	Terminal control mode	0	Two-wire mode 1
F08.00	DI1 function	1	Forward RUN(FWD)
F08.01	DI2 function	2	Reverse RUN(REV)
F08.02	DI3 function	3	Three-wire operation control

0: Two-wire mode 1

Integration of operation and direction. This is the most commonly used two-wire mode. The factory default is DI1(Forward RUN) and DI2 (Reverse RUN) terminal commands to determine the forward or reverse operation of

K1	K2	Operation command
0	0	Stop
1	0	Forward run
0	1	Reverse run
1	1	Stop

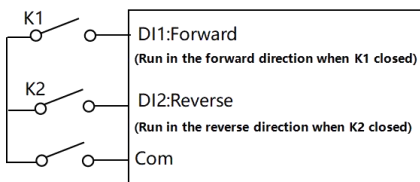

the motor. See the following figure.

Figure 5-1 Schematic diagram of two-wire control 1

1: Two-wire mode 2

Separation of operation and direction. The forward run terminal DI1 defined in this mode is the run enable terminal , The direction is defined by the state of the reverse run terminal DI2 , See the following figure.

K1	K2	Operation command
0	0	Stop
1	0	Forward run
1	1	Reverse run
0	1	Stop

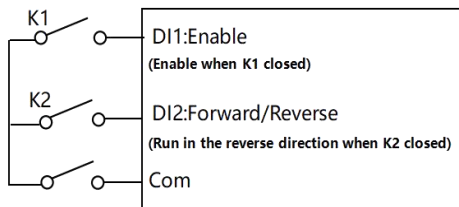

Figure 5-2 Schematic diagram of two-wire control 2

2: Three-wire mode 1

In this mode, the stop of the AC drive are controlled through the three-wire running control terminal (DI3), and the running command is generated by the forward run terminal DI1(Forward RUN) or the reverse run terminal DI2 (Reverse RUN), and the two control the running direction at the same time. See the following figure.

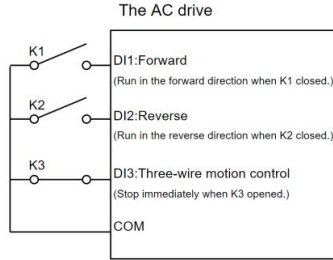

Figure 5-3 Schematic diagram of three-wire mode 1

3: Three-wire mode 2

In this mode, the stop of the AC drive are controlled through the three-wire running control terminal (DI3). The running command is generated by the forward run terminal DI1(Forward RUN), and the direction is defined by the state of the reverse run terminal DI2 (Reverse RUN). The three-wire operation control terminal (DI3) is a valid input. See the following figure.

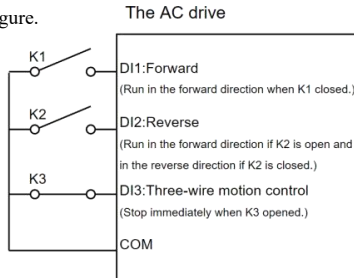

Figure 5-4 Schematic diagram of three-wire mode 2

5.1.4 Communication control

When F01.03 is set to 2, the start and stop of the AC drive are controlled through communication. When the AC drive is controlled through serial communication, the host controller must send a write command to the AC drive.

Here takes the Modbus protocol as an example to describe how to control the AC drive through communication.

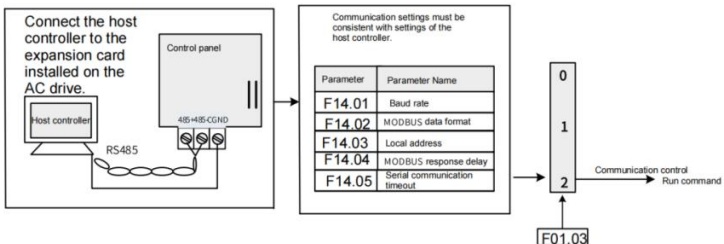

Figure 5-5 Setting commands through communication

Application :

To make the AC drive run in reverse direction, the host computer sends the write command 01 06 70 00 00 02 12 CB (hexadecimal). The following table describes the meaning of each byte in the command. (The command is in hexadecimal format.)

For other communication addresses and control commands, see "Appendix I: Modbus Protocol".

Table 5-4 Communication command 01 06 70 00 00 02 12 CB interpretation

Command	Description
01H(configurable)	AC drive address
06H	Write command
7000H	Control command communication address
0002H(reverse RUN)	Control command
12CBH	CRC check

Table 5-5 The master and slave communication commands and responses

Host Command		Slave Response	
ADDR	01H	ADDR	01H
CMD	06H	CMD	06H
High-order bits of parameter address	70H	High-order bits of parameter address	70H
Low-order bits of parameter address	00H	Low-order bits of parameter address	00H
High-order bits of data content	00H	High-order bits of data content	00H
Low-order bits of data content	02H	Low-order bits of data content	02H
CRC high-order bits	12H	CRC high-order bits	12H
CRC low-order bits	CBH	CRC low-order bits	CBH

Here takes the CANopen protocol as an example to describe how to control the AC drive through communication.

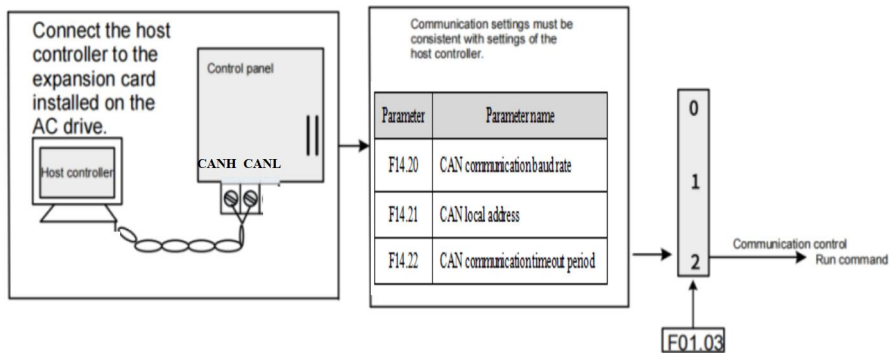

Figure 5-6 Setting commands through communication

Application :

To make the AC drive run in reverse direction, the host computer sends the write command 601 2B 70 20 00 02 00 (hexadecimal). The following table describes the meaning of each byte in the command. (The command is in hexadecimal format.)

For other communication addresses and control commands, see "Appendix II: CANopen Protocol".

Table 5-6 Communication command 601 2B 70 20 00 02 00 interpretation

Command	Description
601H	600+001,COB-ID,600 means the message type is SDO, 001 is the frequency converter address (can be set)
2BH	SDO writes commands that write two bytes of data
7020H	That is, 2070H, control command communication address primary index (low first, high last)
00H	Control command communication address subindex
0200H(Reverse RUN)	Control command

Table 5-7 The master and slave communication commands and responses

Host Command		Slave Response	
COB-ID	601H	COB-ID	581H
CMD	2BH	CMD	60H
Parameter primary index low	70H	Parameter primary index low	70H
Parameter primary index high	20H	Parameter primary index high	20H
Parameter subindex	00H	Parameter subindex	00H
Low-order bits of data content	02H	Low-order bits of data content	02H
High-order bits of data content	00H	High-order bits of data content	00H

5.2 Frequency reference sources

5.2.1 Setting frequency reference sources

The AC drive supports three frequency references: main frequency reference, auxiliary frequency reference, and main and auxiliary frequency superposition.

5.2.2 Selecting source of main frequency reference

The AC drive supports more than 8 main frequency sources, including operating panel digital setting, AI, panel potentiometer, communication, pulse input, PID, multi-reference, simple PLC, which can be selected by setting F01.04 (0 to 9).

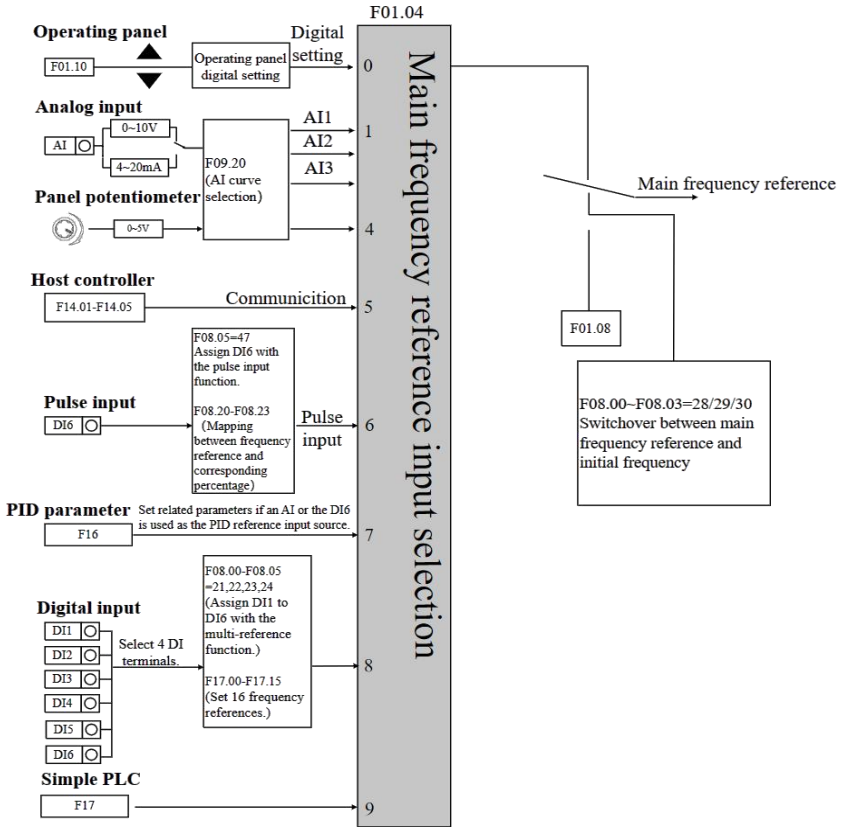

Figure 5-7 Main frequency reference selection

Table 5-8 Source of main frequency reference parameter

Parameter code (address)	Name	Content	Default (Value Range)
F01.04 (0x0104)	Main frequency source X	0: Keyboard number given frequency (F01.10) 1: AI1 given 2: AI2 Given 3: AI3 given 4: The keyboard potential meter is fixed 5: Communication given 6: Pulse given (DI6) 7: PID given 8: Multi -stage speed instructions 9: Simple PLC	0 (0~9)

5.2.3 Setting main frequency through operating panel

When the main frequency is set through operating panel (F01.04 is set to 0), the frequency can be corrected by the UP and DOWN keys. F01.17 determines whether the corrected frequency is remembered during shutdown or power failure.

Table 5-9 Frequency related parameters

Parameter code (address)	Name	Content	Default (Value Range)
F01.10 (0x010A)	Digital setting frequency	This parameter defines the Digital setting frequency.	50.00Hz (0.00Hz~F01.11)
F01.11 (0x010B)	Maximum frequency	This parameter defines the maximum output frequency of the AC drive.	50.00Hz (50.00~600.00Hz)

Table 5-10 Frequency retention parameter

Parameter code (address)	Name	Content	Default (Value Range)
F01.17 (0x0111)	Retention of digital setting of frequency	Ones: Stop retention selection 0: Non-retention 1: Retention Tens: Power down retention selection 0: Non-retention 1: Retention	00 (00~11)

5.2.4 Setting main frequency through analog input (AI Or Panel Potentiometer)

When the main frequency is set through analog input, AI(F01.04 is set to 1,2,3), or Panel Potentiometer(F01.04 is set to 4) can be used.

When an AI terminal is used as the frequency source(the operating panel potentiometer Settings are the same as the AI Settings), it supports a variety of AI curves. Therefore, first introduce the setting method of AI curve, and then introduce how to select the corresponding AI curve of AI terminal. take AI1 for example, see the following steps.

Table 5-11 Set the AI input primary frequency steps

Step 1: Setting AI Curve

Step	Related Parameters	Description
Step 1 Set the AI curve: Set the relationship between the AI voltage/current inputs and frequency setpoints.	F09.21~F09.48	Curve 1 setting and Curve 5 setting
Step 2 Select an AI curve for the AI terminal: Select a curve and filter time for the AI terminal.	F09.00~F09.20	AI gain, offset, filter time, AI curve type
Step 3 Select an AI terminal as the frequency reference source: Select the AI terminal for setting the frequency reference based on terminal characteristics.	F01.04 (Main frequency reference source X)	F01.04 = 1 Select AI

There are 5 types of AI curves, curve 1, curve 2 and curve 3 are 2 points curve, and curve 4 and curve 5 are 4 point curves. Related parameters are F09.21 ~ F09.24 (curve 1), F09.25 ~ F09.28 (curve 2), F09.29 ~ F09.32 (curve 3), F09.33 ~ F09.40 (curve 4), F09.41 ~ F09.48 (curve 5). The setting of the AI curve is actually the relationship between the setting voltage (or analog quantity input current) and the set value of its representative.

Taking the setting method of AI curve 1 as an example to explain the setting method of 2-point curve 1, curve 2, and curve 3, the related parameters are F09.21 ~ F09.24.

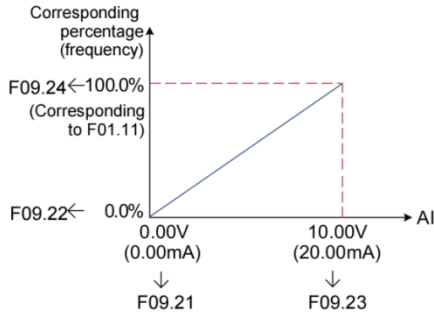

Figure 5-8 Settings of AI curve 1

When AI is given as a frequency given, the 100.0% of the voltage or current input is the percentage of the corresponding setting of the corresponding setting. When the analog input is a current input, the IMA current is equivalent to 0.5V voltage, and 0 to 20mA is equivalent to -10 to 10V voltage.

The functions of curve 4 and curve 5 are similar to curve 1 ~ curve 3, which can achieve a more flexible corresponding relationship. In the curve 4 and 5, the X-axis represents an analog input voltage (or analog input current), and the Y axis represents the setting of the corresponding setting of an analog input, that is, the percentage of the relative to maximum frequency (F01.11). There are 4 points on the AI curve 4 and 5, which are minimum input, turning point 1. Attack point 2. Maximum input. F09.33 corresponds to the X-axis of the minimum input point, that is, the minimum analog input voltage (or minimum analog input current). When the curve 4 and the curve 5 are set, the minimum input voltage, turning point 1 voltage, turning point 2 voltage, and maximum voltage of the curve must increase in order. The correlation parameters of curve 4 are F09.33 ~ F09.40, and the correlation parameters of curve 5 are F09.41 ~ F09.48.

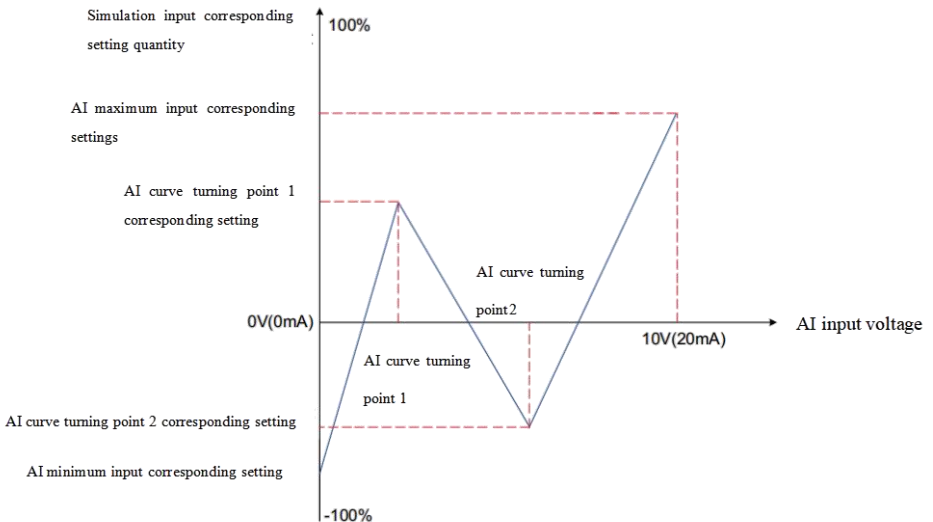

Figure 5-9 Setting AI curves 4 and 5

Step 2: Selecting AI Curve for AI Terminal

The curves of terminals Analog Input are determined by F09.20.

Longer AI input filter time indicates stronger anti-interference capability but slower adjustment response.

Shorter filter time indicates faster adjustment response but weaker anti-interference capability. If the onsite analog input is prone to interference, you can increase the filter time to stabilize the detected analog input. However, increasing the AI filter time will slow down the response to analog detection. Therefore, the filter time must be set properly based on actual conditions.

Step 3: The setting method of the AI terminal as the main frequency

The control board provides 2 analog input terminal AI and a panel potential meter with its own panel. AI1 and AI2 terminals can be voltage input of 0 to 10V, or 0 ~ 20mA current input. AI3 (optional expansion card) support-10 ~+10V voltage input. Take AI1 for example, the following introduces the setting method of the AI terminal as the main frequency.

For example, the AI terminal selects the curve 1 (the ones position of F09.20 is set to 1), and when the AI voltage input terminal is used as a frequency source, it needs to reach 2V ~ 10V corresponding to 10 Hz to 40Hz. The parameter setting method is as shown in Figure:

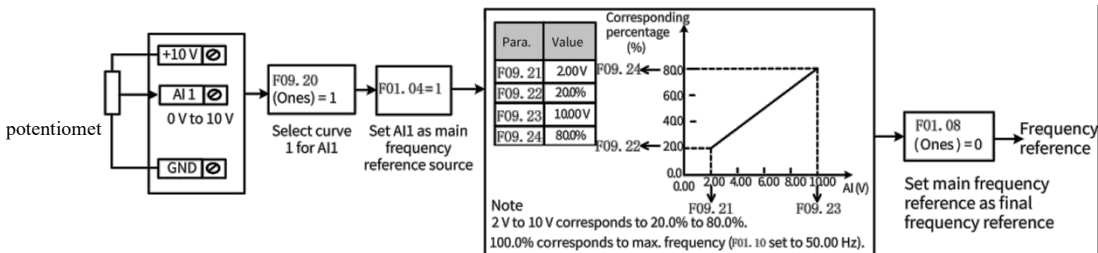

Figure 5-10 Parameter settings for AI voltage input as the main frequency source

The AI terminal can be used as an analog voltage input (-10V ~ 10V) or an analog current input (0mA ~ 20mA). When the AI channel is an analog current input, if the input current ranges from 0mA to 20mA, the input voltage ranges from -10V to 10V. If the input current is 4mA to 20mA, then 4mA corresponds to -8V and 20mA corresponds to 10V.

Table 5-12 AI terminal function parameter

Parameter code (address)	Name	Content	Default (Value Range)
F09.00 (0x0900)	AI1 gain	Adjust the input analog value of the AI1 terminal	1.00 (-10.00~10.00)
F09.01 (0x0901)	AI1 offset	Set the AI1 input offset to adjust the zero of the terminal output	0.0% (-100.0%~100.0%)
F09.02 (0x0902)	AI1 Filter time	Define the size of the simulation signal to eliminate interference signals.	0.10s (0.00s~10.00s)
F09.03 (0x0903)	AI2 gain	Adjust the input analog value of the AI2terminal	1.00 (-10.00~10.00)
F09.04 (0x0904)	AI2 offset	Set the AI2 input offset to adjust the zero of the terminal output	0.0% (-100.0%~100.0%)
F09.05 (0x0905)	AI2 Filter time	Define the size of the simulation signal to eliminate interference signals.	0.10s (0.00s~10.00s)
F09.06 (0x0906)	AI3 gain	Adjust the input analog value of the AI3 terminal	1.00 (-10.00~10.00)
F09.07 (0x0907)	AI3 offset	Set the AI3 input offset to adjust the zero of the terminal output	0.0% (-100.0%~100.0%)
F09.08 (0x0908)	AI3 Filter time	Define the size of the simulation signal to eliminate interference signals.	0.10s (0.00s~10.00s)
F09.09 (0x0909)	Keyboard potentiometer gain	Adjust the value of the keyboard potentiometer input analog	1.00 (-10.00~10.00)

F09.10 (0x090A)	Keyboard potentiometer offset	Set the keyboard potentiometer offset to adjust the zero point of the terminal output.	0.0% (-100.0%~100.0%)
F09.11 (0x090B)	Keyboard potentiometer filter time	Defines the size of the filter for the analog signal to eliminate interference signals.	0.10s (0.00s~10.00s)
F09.12 (0x090C)	AI upper and lower limit cutoff values	Set the upper and lower limit cutoff values of the AI terminal	0.0% (0.0%~20.0%)
F09.13 (0x090D)	AI upper and lower limit truncation selection	Units digit: AI1 Tenth place: AI2 Hundreds: AI3 Thousands place: keyboard potentiometer 0: No truncation 1: Truncate	0 (0000~1111)
F09.20 (0x0914)	AI curve type	Units digit: AI1 Tenth place: AI2 Hundreds: AI3 Thousands place: keyboard potentiometer 1: Curve 1 2: Curve 2 3: Curve 3 4: Curve 4 5: Curve 5	0X1321 (0X1111~0X3555)
F09.21 (0x0915)	AI curve 1 minimum input	Set the minimum signal input to AI curve 1. Voltage signals lower than this value will be processed as the minimum value.	0.00V (0.00~F09.23)
F09.22 (0x0916)	AI curve 1 minimum input corresponding setting	Corresponds to the set percentage value	0.0% (-100.0%~100.0%)
F09.23 (0x0917)	AI curve 1 maximum input	Set the maximum signal input to AI curve 1. Voltage signals higher than this value are processed as the maximum value.	10.00V (F09.21~10.00V)
F09.24 (0x0918)	AI curve 1 maximum input corresponding setting	Corresponds to the set percentage value	100.0% (-100.0%~100.0%)
F09.25 (0x0919)	AI curve 2 minimum input	Set the minimum signal input to AI Curve 2. Voltage signals lower than this value will be processed as the minimum value.	0.00V (0.00V~F09.27)
F09.26 (0x091A)	AI curve 2 minimum input corresponding setting	Corresponds to the set percentage value	0.0% (-100.0%~100.0%)
F09.27 (0x091B)	AI curve 2 maximum input	Set the maximum signal input to AI curve 2. Voltage signals higher than this value are processed as the maximum value.	10.00V (F09.25~10.00V)
F09.28 (0x091C)	AI curve 2 maximum input corresponding setting	Corresponds to the set percentage value	100.0% (-100.0%~100.0%)
F09.29 (0x091D)	AI curve 3 minimum input	Set the minimum signal input to AI curve 3. Voltage signals lower than this value will be processed as the minimum value.	0.00V (0.00V~F09.31)
F09.30 (0x091E)	AI curve 3 minimum input corresponding setting	Corresponding to the set percentage value	0.0% (-100.0%~100.0%)
F09.31 (0x091F)	AI curve 3 maximum input	Set the maximum signal input to AI curve 3. Voltage signals higher than this value are processed as the maximum value.	10.00V (F09.29~10.00V)

F09.32 (0x0920)	AI curve 3 maximum input corresponding setting	Corresponds to the set percentage value	100.0% (-100.0%~100.0%)
F09.33 (0x0921)	AI curve 4 minimum input	Set the minimum signal input to AI curve 4. Voltage signals lower than this value will be processed as the minimum value.	0.00V (0.00V~F09.35)
F09.34 (0x0922)	AI curve 4 minimum input corresponding setting	Corresponding to the set percentage value	0.0% (-100.0%~100.0%)
F09.35 (0x0923)	AI curve 4 inflection point 1 input	Set the signal input to the AI curve 4 inflection point 1	3.50V (F09.33~F09.37)
F09.36 (0x0924)	AI curve 4 inflection point 1 input corresponding setting	Corresponds to the set percentage value	35.0% (-100.0%~100.0%)
F09.37 (0x0925)	AI curve 4 inflection point 2 input	Set the signal input to the AI curve 4 inflection point 2	7.00V (F09.35~F09.39)
F09.38 (0x0926)	AI curve 4 inflection point 2 input corresponding setting	Corresponds to the set percentage value	70.0% (-100.0%~100.0%)
F09.39 (0x0927)	AI curve 4 maximum input	Set the maximum signal input to AI curve 4. Voltage signals higher than this value are processed as the maximum value.	10.00V (F09.37~10.00V)
F09.40 (0x0928)	AI curve 4 maximum input corresponding setting	Corresponds to the set percentage value	100.0% (-100.0%~100.0%)
F09.41 (0x0929)	AI curve 5 minimum input	Set the minimum signal input to AI curve 5. Voltage signals lower than this value will be processed as the minimum value.	0.00V (-10.00V~F09.43)
F09.42 (0x092A)	AI curve 5 minimum input corresponding setting	Corresponds to the set percentage value	0.0% (-100.0%~100.0%)
F09.43 (0x092B)	AI curve 5 inflection point 1 input	Set the signal input to AI curve 5 inflection point 1	3.50V (F09.41~F09.45)
F09.44 (0x092C)	AI curve 5 inflection point 1 input corresponding setting	Corresponds to the set percentage value	35.0% (-100.0%~100.0%)
F09.45 (0x092D)	AI curve 5 inflection point 2 input	Set the signal input to AI curve 5 inflection point 2	7.00V (F09.43~F09.47)
F09.46 (0x092E)	AI curve 5 inflection point 2 input corresponding setting	Corresponds to the set percentage value	70.0% (-100.0%~100.0%)
F09.47 (0x092F)	AI curve 5 maximum input	Set the maximum signal input to AI curve 5. Voltage signals higher than this value are processed as the maximum value.	10.00V (F09.45~10.00V)
F09.48 (0x0930)	AI curve 5 maximum input corresponding setting	Corresponds to the set percentage value	100.0% (-100.0%~100.0%)

5.2.5 Setting the main frequency through communication

KC200 supports Modbus communication protocol. When performing Modbus communication, you need to set F14.01 (baud rate), F14.02 (data format), and F14.03 (local address).

Application examples:

Step 1, set parameter F01.04 = 5, and select communication as the main frequency command source;

Step 2: Send a write command to the AC drive through the host computer;

The following uses the Modbus protocol as an example to illustrate the process of specifying the main

frequency through communication. For example, when the frequency is set to 50.00Hz using the communication reference method, the write command sent is 01 06 70 10 27 10 88 F3.

Table 5-13 Communication command 01 06 70 10 27 10 88 F3 Interpretation table

Byte	meaning
01H(Can be set)	AC drive address
06H	write command
7010H	mailing address
2710H (converted to decimal 10000, refers to 100% of the maximum frequency)	Target frequency value
88F3H	CRC check

In the same way, when the frequency is set to 25.00Hz using the communication given method, the write command sent is 01 06 70 10 13 88 9F 99. Among them, 13 88 is 5000 converted to hexadecimal, which refers to 50% of the maximum frequency.

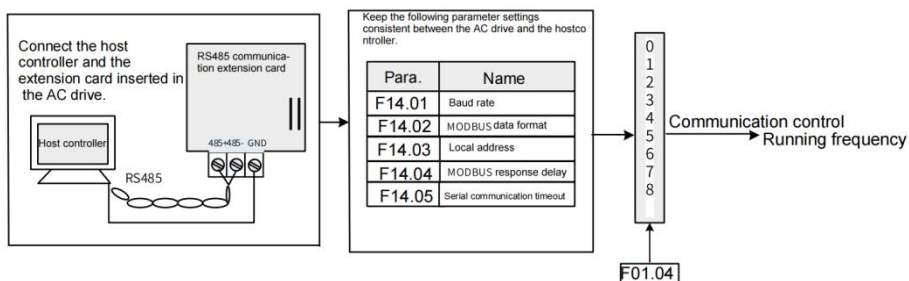

Figure 5-11 Communication as main frequency related parameter settings

Table 5-14 Correspondence between host command and slave response information

Host Command		Slave Response	
ADDR	01H	ADDR	01H
CMD	06H	CMD	06H
High-order bits of parameter address	70H	High-order bits of parameter address	70H
Low-order bits of parameter address	10H	Low-order bits of parameter address	10H
High-order bits of data content	27H	High-order bits of data content	27H
Low-order bits of data content	10H	Low-order bits of data content	10H
CRC high-order bits	88H	CRC high-order bits	88H
CRC low-order bits	F3H	CRC low-order bits	F3H

The frequency range corresponding to the given frequency range of the communication method is 0% ~ 100.00% (100.00% corresponds to the maximum frequency). Assume that F01.11 "Maximum frequency" is set to 50.00Hz. If the frequency value written in the write command is 2710H, convert the decimal value to 10000. Then the actual written frequency value is 50.00*100%=50.00Hz.

KC200also supports CANopen communication protocol. When CANopen communication is performed, F14.20(CAN communication baud rate) and F14.21(CAN local address) need to be set.

Application examples:

- Step 1, set parameter F01.04 = 5, and select communication as the main frequency command source;
- Step 2: Send a write command to the AC drive through the host computer;

The following uses the CANopen protocol as an example to illustrate the process of specifying the main frequency through communication. For example, when the frequency is set to 50.00Hz using the communication reference method, the write command sent is 601 2B 70 20 10 10 27.

Table 5-15 Communication command 601 2B 70 20 10 10 27 interpretation table

Byte	meaning
601H	600+001,COB-ID,600 means the message type is SDO, 001 is the frequency converter address (can be set)
2BH	SDO writes commands that write two bytes of data
7020H	Communication address primary index , Low byte is in front and high byte is behind. The high byte 20 indicates function code main index high, which is always 0x20. The low byte 70 indicates the corresponding communications control parameter group address high byte 0x70
10H	Target frequency value
1027H	Target frequency value, low bit in the front and high bit in the back, that is, 2710H(converted to decimal 10000, referring to 100% of the maximum frequency)

In the same way, when the frequency is set to 25.00Hz using the communication given method, the write command sent is 601 2B 70 20 10 88 13. Among them, 1388 is 5000 converted to hexadecimal, which refers to 50% of the maximum frequency.

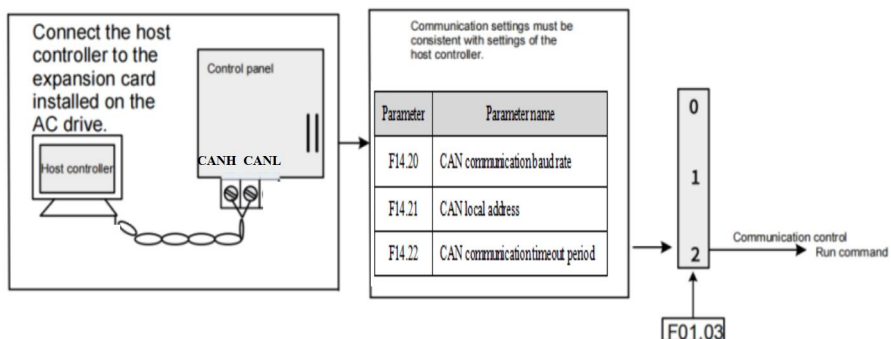

Figure 5-12 Communication as main frequency related parameter settings

Table 5-16 Correspondence between host command and slave response information

Host Command		Slave Response	
COB-ID	601H	COB-ID	581H
CMD	2BH	CMD	60H
Parameter primary index low	70H	Parameter primary index low	70H
Parameter primary index high	20H	Parameter primary index high	20H
Parameter subindex	10H	Parameter subindex	10H
Low-order bits of data content	10H	Low-order bits of data content	10H
High-order bits of data content	27H	High-order bits of data content	27H

The frequency range corresponding to the given frequency range is 0% ~ 100.00%(100.00% corresponds to the maximum frequency). Suppose F01.11 "Max frequency" is set to 50.00Hz. If the frequency of the write command is 2710H, convert the decimal to 10000. Then the actual written frequency value is 50.00*100%=50.00Hz.

5.2.6 Setting main frequency through pulse input

Set the main frequency through PULSE pulse. Only DI6 supports high-speed pulse input.

Pulse given signal specifications: input voltage range 0V ~ 30V, frequency range 0kHz ~ 100kHz.

Table 5-17 Digital pulse input (DI6) as the main frequency command Setting steps

Step	Related Parameters	Description
Select digital pulse input (DI6) as frequency command	F01.04、F08.05	Set F01.04 = 6 and select the main frequency command as "PULSE pulse reference (DI6)". Set F08.05 = 47, and select the DI6 terminal function as "high-speed pulse input (DI6)".
Corresponding relationship curve between set pulse frequency and set frequency	F08.20~F08.23	Typical setting curve 【1】
Set maximum frequency	F01.11	When digital pulse is used as frequency reference, it corresponds to 100.0% of the setting, which is the relative maximum frequency F01.11.
Set the filter time for the set frequency	F08.24	Set the frequency filter time.

【1】The typical setting curve when high-speed pulse input is used as frequency command is as shown in the figure below.

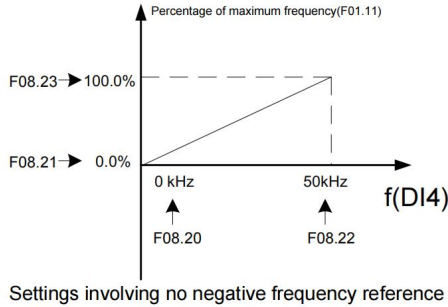

Figure 5-13 Typical setting curve when DI6 is used as frequency command

Table 5-18 High speed pulse input setting parameters

Parameter code (address)	Name	Content	Default (Value Range)
F08.20 (0x0814)	Minimum pulse input frequency	This parameter defines Minimum pulse input frequency.	0.00kHz (0.00kHz~F08.22)
F08.21 (0x0815)	Percentage corresponding to minimum pulse input frequency	This parameter defines the Percentage corresponding.	0.0% (-100.0%~100.0%)
F08.22 (0x0816)	Maximum pulse input frequency	This parameter defines Maximum pulse input frequency.	50.00kHz (F08.20~100.00kHz)
F08.23 (0x0817)	Percentage corresponding to maximum pulse input frequency	This parameter defines the Percentage corresponding.	100.0% (-100.0%~100.0%)
F08.24 (0x0818)	Pulse filter time	This parameter defines Pulse filter time.	0.10s (0.00s~10.00s)

5.2.7 Setting main frequency through PID

As a general process control method, PID control is a closed-loop mechanism in which each controlled variable is stabilized at the target level through proportional, integral, and differential calculation of the difference between the feedback signal and the target signal of the controlled variable. The output of PID control is used as the running frequency, which generally applies to on-site closed-loop control applications, such as constant pressure closed-loop control and constant tension closed-loop control.

Proportional gain K_p : Once the deviation between PID output and input occurs, the PID controller adjusts the output to reduce the deviation. The speed at which the deviation decreases depends on the proportional coefficient K_p . A larger K_p tends to reduce the deviation faster, but may cause system oscillation, especially at large hysteresis. A smaller K_p indicates lower possibility of oscillation but also slower adjustment. (The value 100.0 indicates that when the difference between PID feedback and reference is 100.0%, the adjustment amplitude of the PID controller on the output frequency reference is the maximum frequency.)

Integral time T_i : It determines the integral adjustment intensity of the PID controller. Shorter integral time indicates greater adjustment intensity. (Integral time refers to the time required for continuous adjustment of the integral regulator to reach the maximum frequency when the deviation between the PID feedback and reference is 100.0%.)

Derivative time T_d : It defines the deviation variation adjustment intensity of the PID controller. Longer derivative time indicates greater adjustment intensity. (Derivative time refers to the time within which the feedback value change reaches 100.0%, and the adjustment amplitude reaches the maximum frequency.)

Application

- Step 1: Set F01.04 to 7 to select PID as the main frequency reference input source.
 - Step 2: Set F16.00 to select a source of PID target reference. If F16.00 is set to 0, set F16.01 (digital setting of PID). The value 100% of this parameter corresponds to the maximum value of PID feedback.
 - Step 3: Set F16.03 to select a PID feedback source.
 - Step 4: Set F16.16 to select a PID action direction.
- The following figure shows the logic of process PID control parameter configuration.

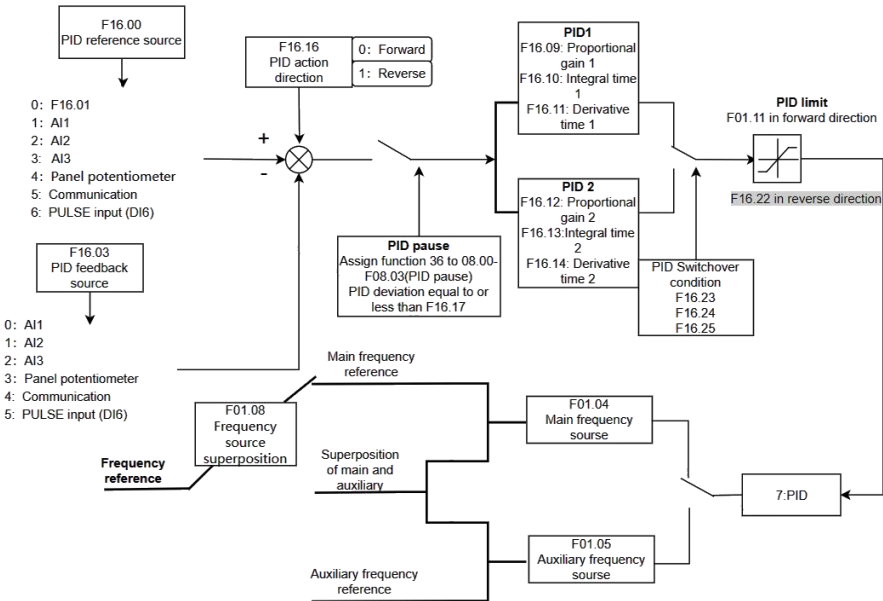

Figure 5-14 Process PID Control parameter setting block diagram

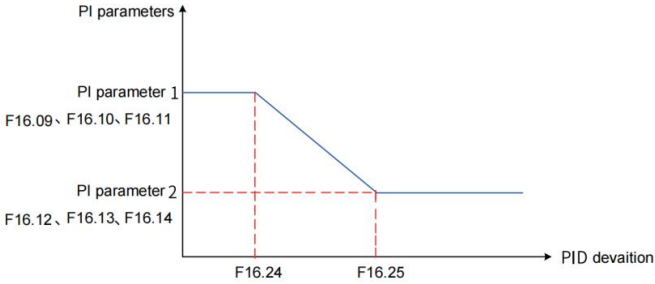

Figure 5-15 PID parameter switching

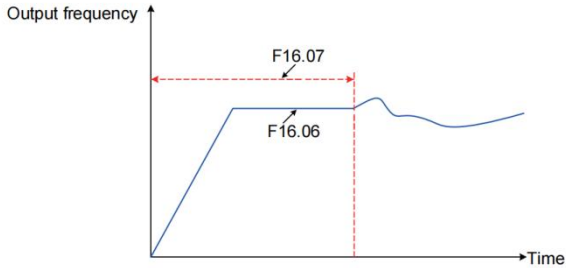

Figure 5-16 PID Initial value function diagram

5.2.8 Setting main frequency through multi-reference

Using the multi-speed command as the input source of the main frequency command is suitable for applications that do not need to continuously adjust the operating frequency of the AC drive and only need to use several frequency values.

KC200 can set up to 16 operating frequencies, which can be selected by a combination of 4 DI terminal input signals. The parameters of the multi-speed command 0 setting mode are F17.00, and the relevant parameters of the multi-speed command 1 to multi-speed command 15 are F17.01 to F17.15.

In addition to the main frequency command, the multi-speed command can also be used as a voltage source for V/F separation and a setting source for process PID.

Application examples:

1. Set parameter F01.04=8 and select multi-speed command as the main frequency;
2. Set the DI terminal function selection. If DI1, DI2, DI3, and DI4 are selected as the signal input terminals for multi-speed frequency designation, set F08.00, F08.01, F08.02, and F08.03 to 21 to 24. The function value specifies the corresponding multi-speed command input terminals 1 to 4.

DI1, DI2, and DI3 are used as signal input terminals for multi-speed frequency designation, and are composed of 4-digit binary numbers in sequence. The values are combined according to the status to select the multi-speed frequency. 4 multi-speed command terminals can be combined into 16 states, and these 16 states correspond to 16 command setting values. The details are as shown in the table below:

Table 5-19 Multi-speed command function description

K4	K3	K2	K1	Reference	Parameter
OFF	OFF	OFF	OFF	Multi-reference 0	Correspond to the channel selected by F17.00

OFF	OFF	OFF	ON	Multi-reference 1	F17.01
OFF	OFF	ON	OFF	Multi-reference 2	F17.02
OFF	OFF	ON	ON	Multi-reference 3	F17.03
OFF	ON	OFF	OFF	Multi-reference 4	F17.04
OFF	ON	OFF	ON	Multi-reference 5	F17.05
OFF	ON	ON	OFF	Multi-reference 6	F17.06
OFF	ON	ON	ON	Multi-reference 7	F17.07
ON	OFF	OFF	OFF	Multi-reference 8	F17.08
ON	OFF	OFF	ON	Multi-reference 9	F17.09
ON	OFF	ON	OFF	Multi-reference 10	F17.10
ON	OFF	ON	ON	Multi-reference 11	F17.11
ON	ON	OFF	OFF	Multi-reference 12	F17.12
ON	ON	OFF	ON	Multi-reference 13	F17.13
ON	ON	ON	OFF	Multi-reference 14	F17.14
ON	ON	ON	ON	Multi-reference 15	F17.15

5.2.9 Setting the main frequency through simple PLC

The first step is to set parameter F01.04=9 and select simple PLC as the main frequency input command. The second step is to set parameters F17.19-F17.50, set parameters F01.23-F01.30, and define the running time and acceleration and deceleration time of each speed.

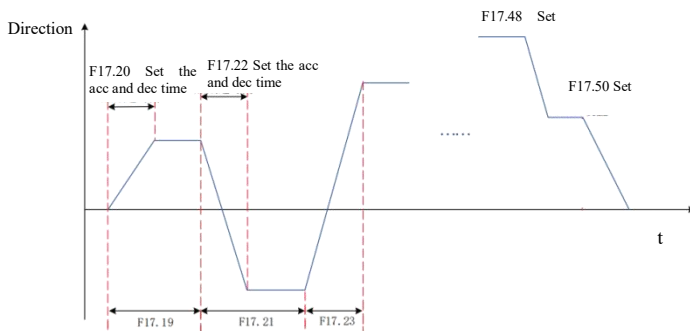

Figure 5-17 Schematic diagram of simple PLC setting master frequency

The third step is to set F17.17, select the simple PLC cycle mode, the timing unit and whether to remember the PLC operating stage and operating frequency before the power failure or shutdown after power failure or shutdown.

5.2.10 Select the input method of auxiliary frequency command

There are 8 kinds of auxiliary frequency instructions of AC drive, which are keyboard number set frequency, AI, keyboard potentiometer, communication set, pulse input, PID, multi-speed instruction, simple PLC. You can select F01.05 by setting parameter values (0 to 9). The auxiliary frequency instruction, when used as an independent frequency given channel, is used in the same way as the main frequency instruction, and the logic block diagram is shown in 5-6. In addition, the auxiliary frequency instruction can also be used as a superposition setting, that is, the combination of the main frequency instruction and the auxiliary frequency instruction to achieve the frequency setting. For details, see "5.2.11 Setting Frequency Based on Main and Auxiliary Frequency References".

Table 5–20 Auxiliary frequency given channel parameter table

Parameter code (address)	Name	Content	Default (Value Range)
F01.05 (0x0105)	Auxiliary frequency source Y	0: Keyboard digital given frequency (F01.10) 1: AI1 given 2: AI2 given 3: AI3 given 4: Keyboard potentiometer given 5: Communication given 6: PULSE pulse setting (DI6) 7: PID given 8: Multi-speed command 9: Simple PLC	0 (0~9)

5.2.11 Setting frequency based on main and auxiliary frequency references

Main and auxiliary frequency reference superposition is used to set the frequency reference by combining the main frequency reference and auxiliary frequency reference. F01.08 defines the relationship between the target frequency and the main and auxiliary frequency references, which is described as follows.

Table 5–21 Relationship between target frequency and main and auxiliary frequency references

No.	Relationship Between Target Frequency and Main and Auxiliary Frequency References	
1	Main frequency reference	The main frequency reference is directly used as the target frequency.
2	Main and auxiliary operation	There are four main and auxiliary operation results: main frequency reference + auxiliary frequency reference, main frequency reference – auxiliary frequency reference, larger value between main frequency reference and auxiliary frequency reference, and smaller value between main frequency reference and auxiliary frequency reference.
3	Frequency switchover	Any of the preceding three frequency sources selected or switched by using the DI terminal. The DI terminal must be assigned with function 28 to 30(frequency reference switchover).

- 0: Operating panel digital setting (F01.10)
- 1: AI1
- 2: AI2
- 3: AI3
- 4: Panel potentiometer
- 5: Communication
- 6: PULSE reference (D16)
- 7: PID
- 8: Multi-reference
- 9: Simple PLC

- 0: Main frequency source X
- 1: Main and auxiliary operation result (based on the tens)
- 2: Switchover between main frequency source X and auxiliary frequency source Y
- 3: Switchover between main frequency source X and main and auxiliary operation result
- 4: Switchover between auxiliary frequency source Y and main and auxiliary operation result

- Terminal function:
- 28: Switchover between main frequency source X and auxiliary frequency source Y
 - 29: Switchover between main frequency source X and main and auxiliary operation result
 - 30: Switchover between auxiliary frequency source Y and main and auxiliary operation result

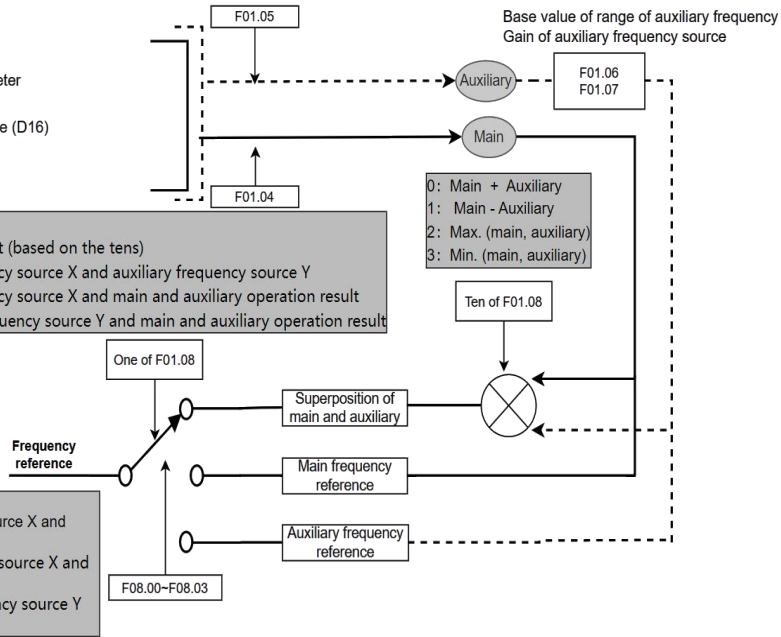



Figure 5-18 Frequency command is the main and auxiliary frequency command superimposed given diagram

Table 5-22 Frequency source parameter

Parameter code (address)	Name	Content	Default (Value range)
F01.08 (0x0108)	Frequency source superposition	Ones: Frequency source selection 0: Main frequency source X 1: Main and auxiliary operation result (based on the tens) 2: Switchover between main frequency source X and auxiliary frequency source Y 3: Switchover between main frequency source X and main and auxiliary operation result 4: Switchover between auxiliary frequency source Y and main and auxiliary operation result Tens: Main and auxiliary frequency source operation 0: Main + Auxiliary 1: Main - Auxiliary 2: Max. (main, auxiliary) 3: Min. (main, auxiliary)	0 (0x00~0x34)
F01.06 (0x0106)	Base value of range of auxiliary frequency source Y	0: Relative to the maximum frequency 1: Relative to main frequency X reference	0 (0~1)
F01.07 (0x0107)	Gain of auxiliary frequency source Y	This parameter defines gain of auxiliary frequency source Y.	100.0% (0.0~150.0%)

When the main frequency is set through main and auxiliary frequency reference superposition, the following need to pay attention to.

1. When the auxiliary frequency reference is set to the digital setting, the frequency is corrected by the UP  and DOWN  keys(or DI terminal is assigned with UP, DOWN) on the basis of the main given frequency. In this case, operating panel digital setting(F01.10) are ineffective.
2. When the auxiliary frequency reference is set to analog input(AI or Panel Potentiometer) or PULSE input, 100% the percentage corresponding refers to the range of auxiliary frequency source Y, set by F01.06 and F01.07.
3. The auxiliary frequency sources and the main frequency sources cannot be set to the same channel, that is, do not set F01.04 and F01.05 to the same value; otherwise, confusion may occur.

5.2.12 Run command to bind main frequency command

By setting F01.09, the respective frequency commands of the three operating commands of the AC drive can be set. The running command channel and the main frequency given channel can be bundled arbitrarily and switched synchronously. This function defines bundled combinations between 3 running command channels and 7 frequency given channels.

When the specified command channel (F01.03) sets the frequency binding channel (the corresponding bit of F01.09), F01.04 will not work at this time, but will be determined by the frequency given channel specified by F01.09.

The setting diagram is as follows:

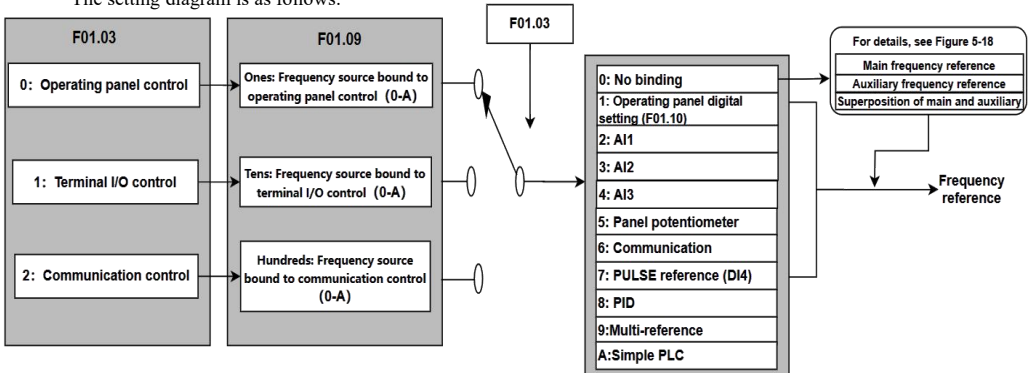

Figure 5-19 Main Frequency Source Bound To The Command Source

Table 5-23 Frequency source bound to the command source parameter

Parameter code (address)	Name	Content	Default (Value range)
F01.09 (0x0109)	Frequency source bound to the command source	Ones: Frequency source bound to operating panel control Tens: Frequency source bound to terminal I/O control Hundreds: Frequency source bound to communication control 0: No binding 1: Operating panel digital setting(F01.10) 2: AI1 3: AI2 4: AI3 5: Panel potentiometer 6: Communication 7: PULSE input(DI6) 8: PID 9: Multi-reference A:Simple PLC	0x000 (0x000~ 0xAAA)

5.2.13 Action setting below lower limit frequency

The frequency lower limit defines the minimum running frequency for the motor.

If the frequency of the AC drive is set to a value below the frequency lower limit (F01.14), you need to set F02.29 to select the action of the AC drive. The actions include the following: run at frequency lower limit, stop in F02.20 mode, and run at zero speed.

0: Run at frequency lower limit

When the running frequency is lower than the frequency lower limit, the AC drive runs at the frequency lower limit.

1: Stop

When the running frequency is lower than the frequency lower limit, the AC drive stops in F02.20 mode.

2: Run at zero speed

When the running frequency is lower than the frequency lower limit, the AC drive runs at zero speed.

Table 5-24 Setting frequency lower limit parameter table

Parameter code (address)	Name	Content	Default (Value range)
F02.29 (0x021D)	Action to take when frequency is below lower limit	0: Run at frequency lower limit 1: Stop in F02.20 mode 2: Run at zero speed	0 (0~2)

5.2.14 Setting frequency reference limits

Maximum frequency: Defines the maximum output frequency.

Frequency upper limit: Limits the maximum operating frequency for motors.

Frequency upper limit source: Defines the reference source of the frequency upper limit.

Related parameter: F01.11~F01.13

5.2.15 Skip frequency

By setting the skip frequency, the AC drive can avoid the mechanical resonance point of the load. Two skip frequency points can be set in KC200. If both skip frequencies are set to 0, the skip frequency function is cancelled¹

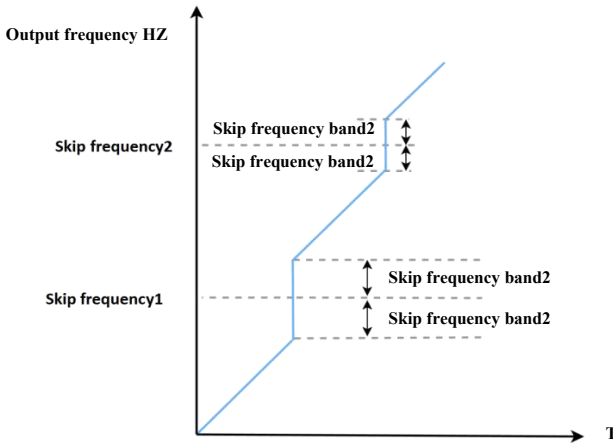

Figure 5-20 Skip frequency diagram

In the figure above, during the acceleration and deceleration process, the operating frequency accelerates to the jump frequency boundary, and the operating frequency of the AC drive will skip the jump frequency, and the jump amplitude is 2 times the jump frequency amplitude.

Table 5-25 Skip frequency related parameter

Parameter code (address)	Name	Content	Default (Value Range)	Description
F02.37 (0x0225)	Skip frequency 1	This parameter defines the first skip frequency.	0.00Hz (0.00Hz~F00.11)	The skip frequency enables the AC drive to avoid any frequency at which a mechanical resonance may occur. This parameter defines the skip frequency. If it is set to 0, the skip frequency is canceled.
F02.39 (0x0227)	Skip frequency 2	This parameter defines the second skip frequency.	0.00Hz (0.00Hz~F00.11)	
F02.38 (0x0226)	Skip frequency band 1	This parameter defines the skip frequency band 1.	0.00Hz (0.00Hz~5.00Hz)	During acceleration, when the running frequency increases to a value that is close to the skip frequency, the AC drive operating frequency skips over the skip frequency. The skip range is twice the value of skip frequency band. During deceleration, when the running frequency decreases to a value that is close to the skip frequency, the AC drive operating frequency skips over the skip frequency. The skip range is twice the value of skip frequency band.
F02.40 (0x0228)	Skip frequency band 2	This parameter defines the skip frequency band 2.	0.00Hz (0.00Hz~5.00Hz)	
F02.36 (0x0224)	Skip frequency enable during acceleration/ deceleration	0: Disabled 1: Enabled	0 (0~1)	This parameter defines whether the skip frequency function is enabled during acceleration/deceleration. 0: During acceleration/deceleration, when the running frequency reaches the skip frequency boundary, the AC drive continues to run at the running frequency. 1: During acceleration/deceleration, when the running frequency reaches the skip frequency boundary, the AC drive skips over the skip frequency. The skip range is twice the value of skip frequency band.

5.3 Jogging

In some applications, the AC drive needs to run at low speed for a short period of time to facilitate testing of the equipment. In this case, inching operation is used. During inching operation, the starting mode is fixed to direct starting mode (F02.00=0), and the stopping mode is fixed to deceleration stop (F02.20=0).

The relationship between output frequency and acceleration and deceleration time during jog operation is shown in the figure below:

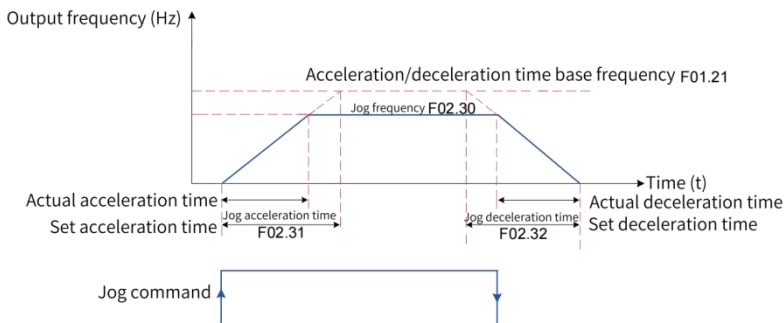

Figure 5-21 Inching operation diagram

Table 5-26 Jogging related parameter

Parameter code (address)	Name	Content	Default (Value range)
F01.03 (0x0103)	Operation command source	0: Operating panel control 1: Terminal I/O control 2: Communication control	0 (0~2)
F01.21 (0x0115)	Base value of the acceleration/deceleration	0: Relative to the maximum frequency 1: Relative to the setting frequency	0 (0~1)
F15.00 (0x0F00)	M key function	0: M key disabled 1: Switchover between operating panel control and remote control (terminal I/O control or communication control) 2: Switchover between forward and reverse run 3: Forward jogging 4: Reverse jogging	0 (0~4)
F02.30 (0x021E)	Jog frequency	This parameter defines the running frequency of the AC drive in <u>jogging</u> mode.	5.00Hz (0.00Hz~F01.11)
F02.31 (0x021F)	Jog acceleration time	This parameter defines the acceleration time of the AC drive in <u>jogging</u> mode.	10.0s (0.1s~6000.0s)
F02.32 (0x0220)	Jog deceleration time	This parameter defines the deceleration time of the AC drive in <u>jogging</u> mode.	10.0s (0.1s~6000.0s)
F02.28 (0x021C)	Reverse frequency inhibition	0: Disabled 1: Enabled	0 (0~1)
F02.35 (0x0223)	Jog preferred	0: OFF Jog preferred 1: Jog preferred	0 (0~1)

Application examples:

The following uses the operation panel jog operation as an example to introduce the parameter settings in jog operation.

Table 5-23 Parameter settings for jog operation using the operation panel

Step	Forward Jogging	Reverse Jogging
1	Set F15.00 to 3 to assign the forward jogging function to the M key.	Set F15.00 to 4 to assign the reverse jogging function to the M key. Set F02.28 (reverse frequency inhibition) to 0 to allow reverse run.
2	Set F01.03 to 0 to select the operating panel as the command source.	Set F01.03 to 0 to select the operating panel as the command source.
3	Set F02.30 (jog frequency), F02.31 (jog acceleration time), and F02.32 (jog deceleration time) properly.	Set F02.30 (jog frequency), F02.31 (jog acceleration time), and F02.32 (jog deceleration time) properly.
4	Press down the M key when the AC drive is in stop state. The AC drive starts to jog in the forward direction. Release the M key. The AC drive decelerates to stop.	Press down the M key when the AC drive is in stop state. The AC drive starts to jog in the forward direction. Release the M key. The AC drive decelerates to stop.

5.4 Start-stop instruction

5.4.1 Startup mode

The AC drive supports three startup modes: direct start, pre-excitation start and speed tracking start. You can set F02.00 to select the startup mode of the AC drive.

5.4.1.1 Direct start

When F02.00 is set to 0, the direct start mode is adopted, which applies to most load applications.

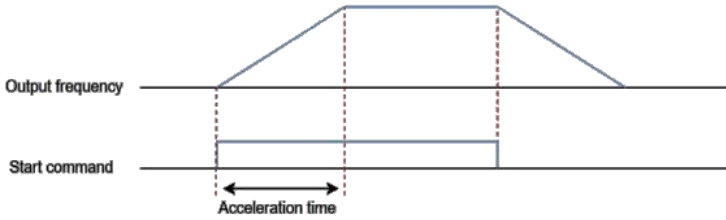

Figure 5-22 Timing diagram of direct start

Startup with startup frequency.

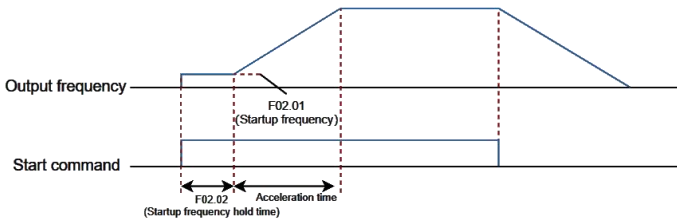

Figure 5-23 Timing diagram of startup with startup frequency

Startup with DC braking is applicable to applications where the motor may rotate at startup.

If the DC braking time is set to 0, the AC drive starts to run at the startup frequency. If the DC braking time is not 0, the AC drive performs DC braking first and then starts to run at the startup frequency. This mode applies to most small-inertia load applications where the motor is likely to rotate at startup.

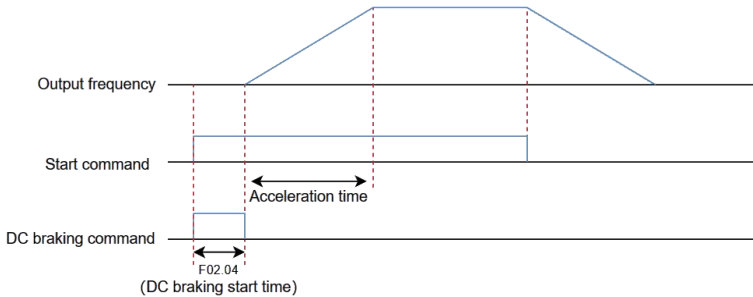

Figure 5-24 Timing diagram of startup with DC braking

The following figure shows the frequency curve during startup:

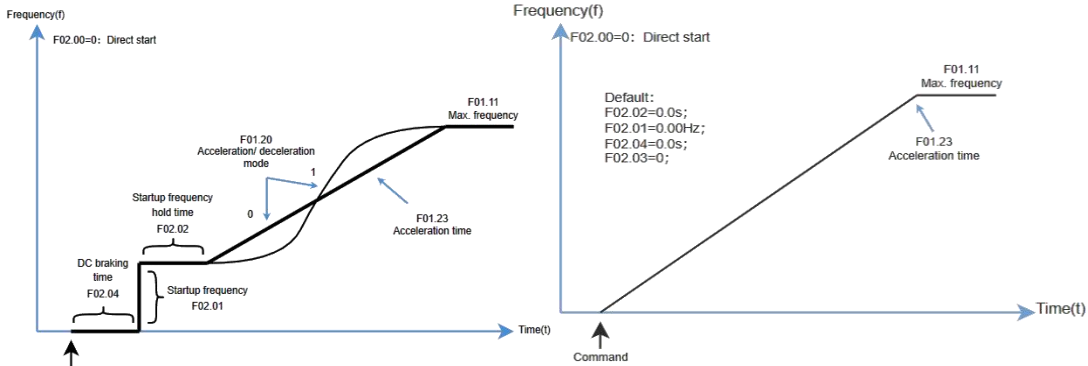

Figure 5-25 Direct start mode

5.4.1.2 Pre-excitation start

When F02.00 is set to 1, the AC drive enters the pre-excitation start mode, which is only applicable to the SVC control mode. Pre-excited the motor before starting can improve the fast response characteristics of the motor, reduce the starting current, meet the application requirements requiring a relatively short acceleration time, and the starting sequence is consistent with the DC braking restart.

5.4.1.3 Speed tracking start

Set the parameter F02.00=2, the AC drive speed tracking start, suitable for restarting the rotating motor, can avoid the occurrence of over current.

5.4.2 Stop mode

There are two ways to stop the AC drive: deceleration stop and free stop. Set parameter F02.20 to select the stop method of the inverter as needed.

5.4.2.1 Decelerate to stop

Set parameter F02.20=0, the AC drive decelerates to a stop. At this time, after the stop command is valid, the AC drive reduces the output frequency according to the deceleration time. After the frequency drops to 0, the inverter will stop output.

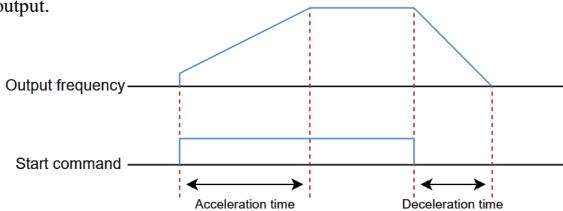

Figure 5-26 Deceleration parking sequence diagram

By setting parameters F02.23 to F02.26, select whether to use the DC braking function at the end of the shutdown period.

Table 5-28 Shutdown setting parameters table

Parameter code (Address)	Name	Content	Factory value (Setting range)
F02.23 (0x0217)	Start frequency of DC braking at stop	The AC drive starts DC braking when the running frequency decreases to the value of this parameter during deceleration to stop	0.00Hz (0.00Hz~F01.11)
F02.24 (0x0218)	DC braking delay at stop	When the running frequency decreases to the start frequency of DC braking at stop, the AC drive stops output and starts DC braking after this waiting time.	0.0s (0.0s~100.0s)
F02.25 (0x0219)	DC braking current at stop	This parameter defines the stopping DC braking current, a larger DC braking current indicates stronger braking force	0% (0%~150%)
F02.26 (0x021A)	Stop DC braking time	This parameter defines the shutdown DC brake hold time	0.0s (0.0s~100.0s)

After the operating frequency is reduced to the setting value of F02.23(stop DC braking initial frequency), the inverter stops output for a period of time according to the setting value of F02.24(stop DC braking waiting time), and then starts the DC braking process after the waiting time reaches. This function can be used to prevent over-current failures that may occur when DC braking starts at higher speeds.

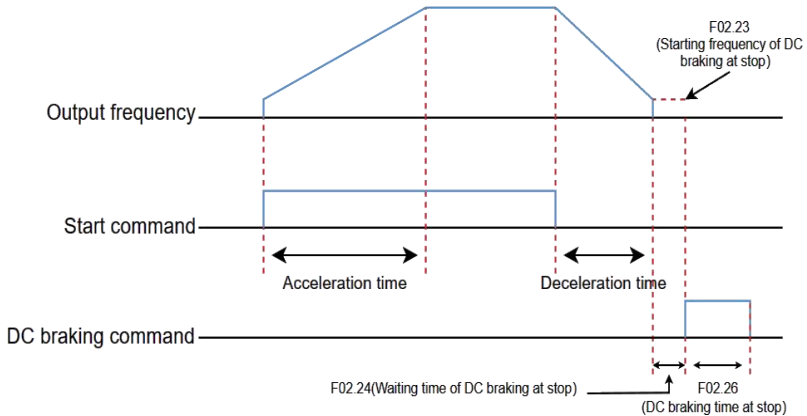

Figure 5-27 Shutdown DC braking timing diagram

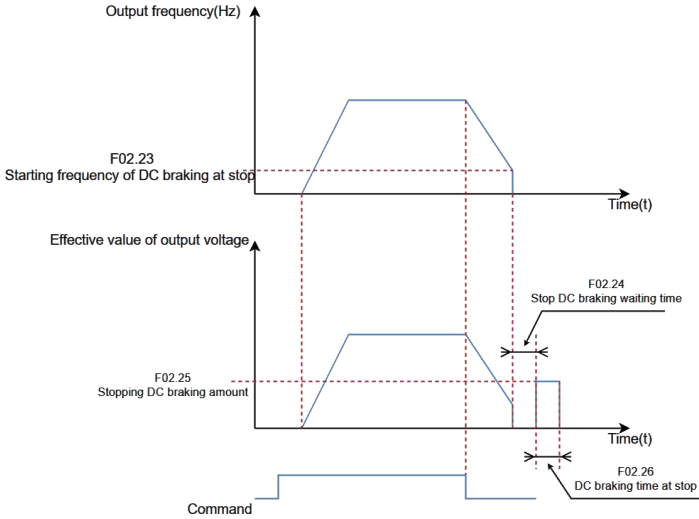

Figure 5-28 Shutdown DC braking process diagram

5.4.2.2 Coast to stop

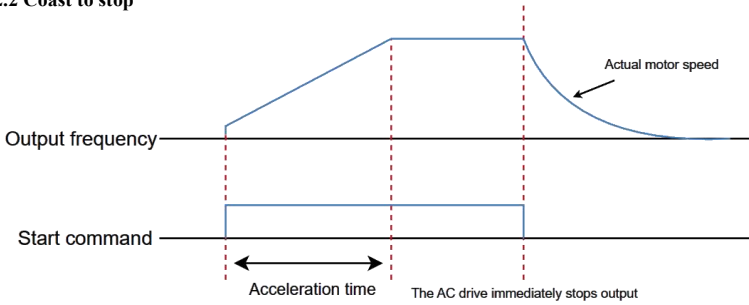

Figure 5-29 Coast to stop timing diagram

5.4.3 Acceleration and deceleration time setting

The acceleration time indicates the time required for the output frequency of the AC drive to rise from 0 to the acceleration/deceleration base frequency (F01.21). The deceleration time indicates the time required for the output frequency of the AC drive to decrease from the acceleration/deceleration base frequency (F01.21) to 0 Hz.

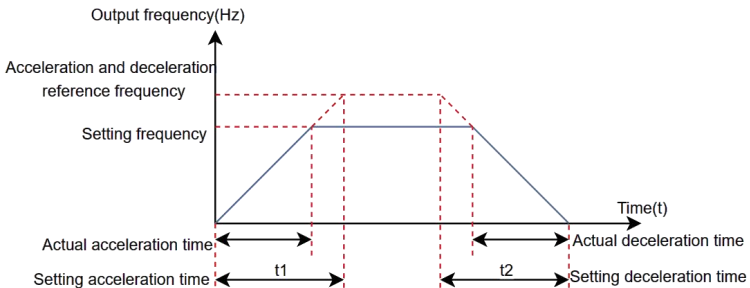

Figure 5-30 Acceleration and deceleration time diagram

The AC drive provides totally four groups of acceleration/deceleration time, which can be selected by using a DI terminal (assigned with function 32/33). The acceleration/deceleration time is defined by the following parameters:

Table 5-29 Acceleration and deceleration time setting parameters table

Parameter code (Address)	Name	Content	Factory value (Setting range)
F01.23 (0x0117)	Acceleration time 1	Acceleration time 1 of output frequency from 0.00Hz to F01.21	5.5KW (220V: 3.7KW) and below: 10.0s 11KW~45KW (220V: 5.5KW~22KW): 20.0s 55KW (220V: 30KW) and above: 50.0s (0.0s~6000.0s)
F01.24 (0x0118)	Deceleration time 1	Deceleration time 1 of output frequency from F01.21 to 0.00Hz	
F01.25 (0x0119)	Acceleration time 2	Acceleration time 2 of output frequency from 0.00Hz to F01.21	
F01.26 (0x011A)	Deceleration Time 2	Deceleration time 2 of output frequency from F01.21 to 0.00Hz	
F01.27 (0x011B)	Acceleration time 3	Acceleration time 3 of output frequency from 0.00Hz to F01.21	
F01.28 (0x011C)	Deceleration Time 3	Deceleration time 3 of output frequency from F01.21 to 0.00Hz	
F01.29 (0x011D)	Acceleration time 4	Acceleration time 4 of output frequency from 0.00Hz to F01.21	
F01.30 (0x011E)	Deceleration Time 4	Deceleration time 4 of output frequency from F01.21 to 0.00Hz	

The AC drive can also automatically switch the acceleration and deceleration time based on the switching frequency. At this time, the DI terminal function cannot be set to the 32 (acceleration/deceleration time switching terminal 1) and 33 (acceleration/deceleration time switching terminal 2) functions.

During the acceleration process, if the operating frequency is less than F01.35, select acceleration time 2; if the operating frequency is greater than F01.35, select acceleration time 1. During the deceleration process, if the operating frequency is greater than F01.36, select deceleration time 1. If the operating frequency is less than F01.36, select deceleration time 2.

Table 5-30 Acceleration and deceleration time switching parameters table

Parameter code (Address)	Name	Content	Factory value (Setting range)
F01.35 (0x0123)	Switching frequency between acceleration time 1 and acceleration time 2	This parameter defines the switching frequency between acceleration time 1 and acceleration time 2	0.00Hz (0.00Hz~F01.11)
F01.36 (0x0124)	Switching frequency between deceleration time 1 and deceleration time 2	This parameter defines the switching frequency between deceleration time 1 with deceleration time 2	0.00Hz (0.00Hz~F01.11)

The schematic diagram of acceleration and deceleration time switching is shown in the following figure::

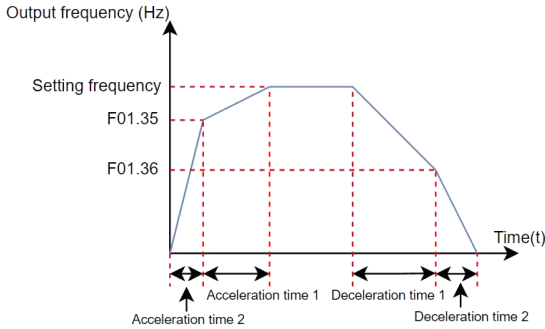

Figure 5-31 Acceleration and deceleration time switching diagram

5.5 Control terminal

5.5.1 Digital input terminal

KC200 comes standard with 6 multi-functional digital input terminals (DI6 can be used as a high-speed pulse input terminal).

The input function of each DI terminal can be defined by setting the values of parameters F08.00~F08.06. For specific functions, see "7.30 Terminal input function selection".

At the same time, you can also set the effective characteristics, filter time and delay time of the DI terminal.

For high-speed pulse input terminal settings, please refer to "5.2.6 Setting the main frequency through pulse input".

Related parameters: Group F08.

5.5.2 Analog input terminal

KC200 comes standard with 2 analog multi-function input terminals (AI1, AI2)

Table 5-31 Description of analog (AI) terminals

Terminal	Name	Type	Input range	Impedance
AI1-GND AI2-GND	Control board analog input terminal	Voltage mode ^[1]	0V~10VDC	20kΩ
		Current mode ^[1]	0mA~20mA	500Ω

[1] Use jumper caps J2 and J3 to select whether AI1 and AI2 are voltage type or current type respectively.

Please refer to "5.2.4 Setting the main frequency through analog quantity (AI or panel potentiometer)" for the AI curve setting method.

Related parameters: Group F09.

5.5.3 Digital output terminal

KC200 comes standard with 2 multi-function digital output terminals (DO1, DO2) and 2 sets of multi-function relay output terminals (TA1/TB1/TC1, TA2/TB2/TC2). Among them, DO1 and DO2 are transistor outputs and can drive a 24V DC low-voltage signal loop; TA1/TB1/TC1 and TA2/TB2/TC2 are relay outputs and can drive a 250V AC control loop.

Table 5-32 List of Digital Output Terminals (DO)

Port name	Corresponding parameters	Output characteristic description
DO1-COM DO2-COM	When F10.05=0, F10.00, F10.01	Transistor; Drive capability: 24VDC, 50mA
DO2-COM	When F10.05=1, F11.02	Transistor; Can output high-frequency pulses from 0.1kHz to 100kHz; Drive capability: 24VDC, 50mA
TA1-TB1-TC1 TA2-TB2-TC2	F10.02, F10.03	Relay; Drive capacity: 250VAC, 3A

By setting the values of parameters F10.00, F10.01, F10.02 and F10.03, each digital output function can be defined to indicate various working states and alarms of the AC drive. For specific functions, see "7.31 Terminal Output Function choose".

Related parameters: F10 group.

5.5.4 Analog output terminal

KC200 comes standard with 2 analog output terminals AO1 and AO2. Use jumper caps J4 and J5 to select whether the AO1 and AO2 outputs are voltage type or current type.

AO1 and AO2 can be used to indicate internal operating parameters in analog mode, and the indicated parameter attributes can be selected through parameters F11.00 and F11.01.

The zero drift of the analog output and the deviation of the output amplitude can be corrected through the AO output curve, as shown in the figure below. If the zero bias is represented by "b", the gain is represented by k, the actual output is represented by Y, and the standard output is represented by X, then the actual output is: $Y=kX+b$.

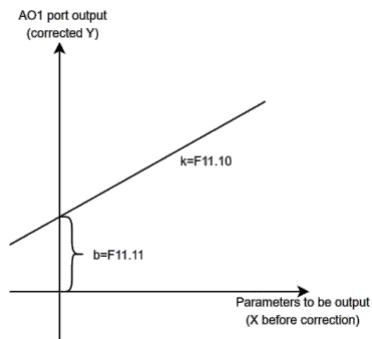

Figure 5-32 AO signal correction characteristic curve

Among them, the zero deviation coefficient of AO is 100% corresponding to 10V (or 20mA), and zero deviation=zero deviation coefficient \times 10V (or 20mA). Standard output refers to the quantity represented by the analog output corresponding to 0V~10V (or 0mA~20mA) without zero bias and gain correction.

Related parameters: F11 group.

5.6 Motor configuration

5.6.1 Motor control mode selection

The motor control mode is set through parameter F01.02 (If motor 2 is selected, it is A00.02,and the corresponding parameter self-learning function code is A03.09). Set to 0, select V/F control (speed open loop control); Set to 1, select Speed Sensorless Vector Control (SVC);Set to 2, select Speed Sensor Vector Control (FVC).

V/F control (speed open loop control): suitable for situations where load requirements are not high or one AC

drive drives multiple motors, such as fan and pump loads. It can be used in situations where one frequency converter drives multiple motors, this control mode is not recommended for synchronous motor.

Speed Sensorless Vector Control (SVC): Refers to open-loop vector control, suitable for high-performance control situations . One AC drive can only drive one motor. Load such as machine tools, centrifuges, wire drawing machines, injection molding machines, etc;

Speed Sensor Vector Control (FVC): Refers to closed-loop vector control, suitable for high-performance control situations .Such as tension control, crane, position control and other high requirements.

5.6.2 Motor parameter self-learning

The process of obtaining the internal electrical parameters of the controlled motor from the AC drive is called self-learning. The methods of self-learning include: static self-learning (partial parameters), rotating self-learning (all parameters), manual input of motor parameters, and other methods. The static self-learning and rotating self-learning are set through parameter F03.09 or A03.09.

The adaptability and tuning effects of several debugging methods are shown in the table below.

Table 5-33 Debugging Methods

Tuning mode	Applicable situation	Tuning effect
No-load motor rotation self-learning (all parameters) F03.09/A03.09 = 2	Where the motor is easily separated from the application system	Best
Static self-learning (partial parameters) F03.09/A03.09 = 1	Where the motor is difficult to separate from the load and does not allow dynamic tuning operation. Synchronous motor cannot learn back electromotive force (F03.23), manual input is required.	Normal
Manual input parameter	When the motor is difficult to separate from the application system, the parameters of the same type of motor that has been successfully tuned by the AC drive are copied and input to the corresponding parameters of F03.10 – F03.14(Asynchronous motor, synchronous motor is F03.20~F03.24)	Preferably

Application :

The steps for automatic tuning of motor parameters are as follows:

- 1.If the motor can be completely disconnected from the load, in the event of a power outage, mechanically separate the motor from the load to allow the motor to rotate freely without load;
- 2.After powering on, first select the frequency converter command command command (F01.03) as the operation panel command channel;
3. Accurately input the nameplate parameters of the motor (such as F03.02~F03.06), please input the following parameters according to the actual motor parameters (based on the current motor selection).

Table 5-34 Motor parameter table needs to be input during self-learning

Parameter code (address)	Name
F03.02 (0x0302)	Rated motor power
F03.03 (0x0303)	Rated motor voltage
F03.04 (0x0304)	Rated motor current
F03.05 (0x0305)	Rated motor frequency
F03.06 (0x0306)	Rated motor speed

4.F03.09 (tuning selection) select 2 and press the ENTER key to confirm. At this time, the keyboard displays EST • 00, as shown in the following figure:



Figure 5-33 Self learning mode operation panel

5. Press the RUN key on the keyboard, and the frequency converter will learn the motor parameters from F03.10 to F03.14 (Asynchronous motor, synchronous motor is F03.20~F03.24). The RUN indicator light will remain on, and the ALM light will flash. The tuning operation will last for about 2 minutes. When the above display information disappears, it will return to the normal parameter display state, indicating that the tuning is completed.

After this complete tuning, the frequency converter will automatically calculate the following parameters of the motor.

Table 5-35 Motor parameter table calculated by self-learning (asynchronous motor)

Parameter code (address)	Name
F03.10 (0x030A)	Asynchronous motor stator resistance
F03.11 (0x030B)	Asynchronous motor rotor resistance
F03.12 (0x030C)	Asynchronous motor leakage inductance
F03.13 (0x030D)	Asynchronous motor mutual inductance
F03.14 (0x030E)	Asynchronous motor no-load current

Table 5-36 Motor parameter table calculated by self-learning (synchronous motor)

Parameter code (address)	Name
F03.20 (0x0314)	Synchronous motor stator resistance
F03.21 (0x0315)	Synchronous motor d- axis inductance
F03.22 (0x0316)	Synchronous motor q- axis inductance
F03.23 (0x0317)	Synchronous motor back electromotive force
F03.24 (0x0318)	Encoder installation angle (the parameter is only learned when F01.02 =2)

5.7 Control performance

5.7.1 Speed loop and torque limit

5.7.1.1 Speed loop

The PI parameters of the speed loop are divided into two groups: low speed and high speed. When the operating frequency is less than F06.04 (switching frequency 1), the PI adjustment parameters of the speed loop are F06.00 (proportional gain of the low speed loop) and F06.01 (integration time of the low speed loop). When the operating frequency is greater than F06.05 (switching frequency 2), the speed loop PI adjustment parameters are F06.02 (high-speed speed loop proportional gain) and F06.03 (high-speed speed loop integration time). The PI parameters of the speed loop between switching frequency 1 and switching frequency 2 are linearly switched between two sets of PI parameters, as shown in the following figure.

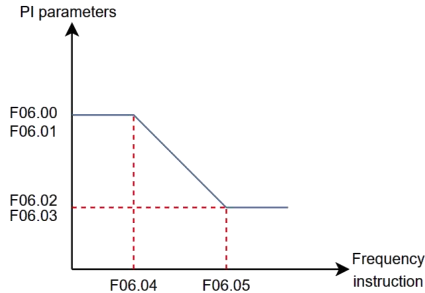

Figure 5-34 Speed loop PI Parameter diagram

By setting the proportional gain and integral time of the speed regulator, you can adjust the dynamic response to speed changes in vector control. Increasing the proportional gain or reducing the integral time can speed up dynamic response of the speed loop. However, excessively large proportional gain or excessively short integral time may cause system oscillation.

In this case, if the parameters obtained by auto-tuning cannot meet the requirements, make fine adjustments based on the parameter values. Increase the proportional gain first to ensure that the system does not oscillate, and then reduce the integral time to ensure that the system has quick response and small overshoot.

Table 5-37 Speed Loop PI Related Parameters Table

Parameter code (address)	Name	Content	Factory value (Setting range)
F06.00 (0x0600)	Low speed loop proportional gain	This parameter defines the low speed loop proportional gain	60 (1~500)
F06.01 (0x0601)	Low speed loop integration time	This parameter defines low speed loop integration time	0.20s (0.01s~5.00s)
F06.02 (0x0602)	High speed loop proportional gain	This parameter defines the high speed loop proportional gain	30 (1~500)
F06.03 (0x0603)	High speed loop integration time	This parameter defines the high speed loop integration time	0.50s (0.01s~5.00s)
F06.04 (0x0604)	Switchover frequency 1	This parameter defines the switchover frequency 1 of the speed loop	5.00Hz (0.00Hz~F06.05)
F06.05 (0x0605)	Switchover frequency 2	This parameter defines the switchover frequency 2 of the speed loop	10.00Hz (F06.04~F01.11)

Explanation:

Improper setting of PI parameters may lead to excessive speed overshoot. Even over-voltage faults occur when overshoot falls back.

5.7.1.2 Speed control torque upper limit

There are two control method for vector control (SVC): speed control and torque control ,and the two control methods have different torque upper limits, which are divided into two groups of parameter settings.

In speed control mode, there are 5 settings for the torque upper limit source. In the electric state, the torque upper limit source is selected by F06.11, and in the power generation state, the torque upper limit source is selected by F06.13. If F06.11 is set to 1-6, the torque upper limit distinguishes between the electric state and the power generation state. The full range of the electric state torque upper limit is set by F06.12 (the torque upper limit in the electric state is based on the rated current of the frequency converter), and the full range of the power generation state torque upper limit is set by F06.14, as shown in the following figure.

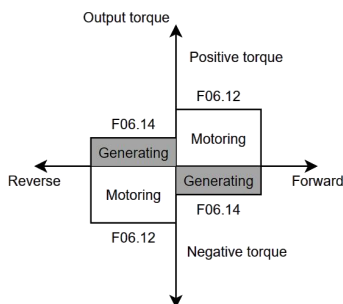

Figure 5-35 Speed control torque upper limit diagram

You can also set the channel for F06.11 by setting F06.10=1 torque limit lock.

Table 5-38 Speed control torque related parameter table

Parameter code (address)	Name	Content	Factory value (Setting range)
F06.10 (0x060A)	Torque lock selection under speed control	0: Not locked 1: The electric power generation torque lock is the setting channel of F06.11	0 (0~1)
F06.11 (0x060B)	Torque upper limit source under speed control (electric)	0: Digital setting (F06.12) 1: AI1 given 2: AI2 given 3: AI3 given 4: Keyboard potentiometer given 5: Communication given 6: PULSE pulse setting (DI6)	0 (0~6)
F06.12 (0x060C)	Torque upper limit setting under speed control (electric)	Set the upper limit of torque under speed control (electric)	180.0% (0.0%~300.0%)
F06.13 (0x060D)	Torque upper limit source under speed control (power generation)	0: Digital setting (F06.14) 1: AI1 given 2: AI2 given 3: AI3 given 4: Keyboard potentiometer given 5: Communication given 6: PULSE pulse setting (DI6)	0 (0~6)
F06.14 (0x060E)	Torque upper limit setting under speed control (power generation)	Set the upper limit of torque under speed control (power generation)	180.0% (0.0%~300.0%)

5.7.1.3 Torque control speed limit

The torque control mode selection is set by F06.30. Two functions related to torque control are involved in the multifunctional digital DI terminals: torque control disable (function 49) and speed control/torque control switch (function 50). These two terminal functions need to be used in conjunction with F06.30 to realize the switch between speed control and torque control.

When the speed control/torque control switching terminal (function 50) is invalid, the control mode is determined by F06.30; When the speed control/torque control switch (function 50) is valid, the control mode equivalent to the value of F06.30 is reversed.

The lower torque setting source is selected by F06.31 setting, and there are 6 torque setting methods.

When the inverter uses torque control, if the load torque is less than the motor output torque, the motor speed will continue to rise, in order to prevent mechanical system accidents such as motor overspeed, it is necessary to limit the maximum motor speed during torque control. For torque control, the acceleration and deceleration time of

the upper frequency limit is set by F01.23-F01.30.

The speed limit source F06.38 is used to set the maximum forward or reverse operating frequency of the inverter under the torque control mode. If it is necessary to dynamically and continuously change the maximum frequency of torque control, it can be achieved by controlling the upper limit frequency.

In the torque control mode, the difference between the motor output torque and the load torque determines the speed change rate of the motor and the load, so the motor speed may change rapidly causing noise or excessive mechanical stress and other problems. By setting the torque control acceleration and deceleration time (F06.34, F06.35), the motor speed can be gently changed.

For example, two motors are hard connected to drive the same load, in order to ensure that the load is evenly distributed, one inverter is set as the host, using the speed control mode, the other inverter is the slave and using torque control, the actual output torque of the host as the slave torque instruction, at this time the slave torque needs to quickly follow the host, then the slave torque control acceleration and deceleration time is 0.00s

Table 5–39 Torque control related parameter table

Parameter code (address)	Name	Content	Factory value (Setting range)
F06.30 (0x061E)	Torque control selection	0: Speed control 1: Torque control	0 (0~1)
F06.31 (0x061F)	Torque setting source selection	0: Digital setting (F06.32) 1: AI1 given 2: AI2 given 3: AI3 given 4: Keyboard potentiometer given 5: Communication given 6: PULSE pulse setting (DI6)	0 (0~6)
F06.32 (0x0620)	Torque digital setting	Set keyboard digital given torque	0.0% (-300.0%~300.0%)
F06.34 (0x0622)	Torque acceleration time	Set torque acceleration time	1.00 (0.00~600.00s)
F06.35 (0x0623)	Torque deceleration time	Set torque deceleration time	1.00 (0.00~600.00s)
F06.38 (0x0626)	Speed limit source selection	0: Digital limit (F06.39 and F06.40) 1: Upper limit frequency limit 2: AI1 given 3: AI2 given 4: AI3 given 5: Keyboard potentiometer limitation 6: Communication given 7: PULSE pulse setting (DI6)	0 (0~7)
F06.39 (0x0627)	Forward speed limit digital setting	Set the limit value of forward speed given by keyboard numbers	50.00Hz (0.00~F01.11)
F06.40 (0x0628)	Negative speed limit digital setting	Set the limit value of negative speed given by keyboard numbers	50.00Hz (0.00~F01.11)

5.7.1.4 Vector Control Slip Gain

In SVC control mode, the stability accuracy of the motor is improved by adjusting the F06.06 vector control slip compensation gain. For example, when the motor operating frequency is lower than the output frequency of the AC drive, the vector control slip compensation gain can be increased.

5.7.2 Current loop

The PI adjustment parameters of the vector control current loop are divided into two groups: excitation and torque. This parameter is automatically obtained after the asynchronous machine is fully tuned and generally does not need to be modified.

If the PI gain of the current loop is set too high, it may cause the entire control loop to oscillate. When the current oscillation or torque fluctuation is large, the PI proportional gain or integral gain can be manually reduced

here.

Table 5-40 Current loop related parameters table

Parameter code (address)	Name	Content	Factory value (Setting range)
F07.00 (0x0700)	Current loop excitation shaft proportional gain	This parameter defines the current loop excitation shaft proportional gain	2000 (0~60000)
F07.01 (0x0701)	Current loop excitation shaft integral gain	This parameter defines the current loop excitation shaft integral gain	1000 (0~60000)
F07.02 (0x0702)	Current loop torque shaft proportional gain	This parameter defines the current loop torque shaft proportional gain	2000 (0~60000)
F07.03 (0x0703)	Current loop torque shaft integral gain	This parameter defines the current loop torque shaft integral gain	1000 (0~60000)

5.7.3 Over-current control

During acceleration, constant speed, and deceleration, if the current exceeds the over-current stall action current, the over-current control function will suppress excessive current. When the current exceeds the over-current stall action current, reduce the output frequency until the current returns below the over-current stall point. The frequency begins to accelerate to the target frequency, and the acceleration time automatically lengthens. If the actual acceleration time cannot meet the requirements, the over-current stall action current can be appropriately increased.

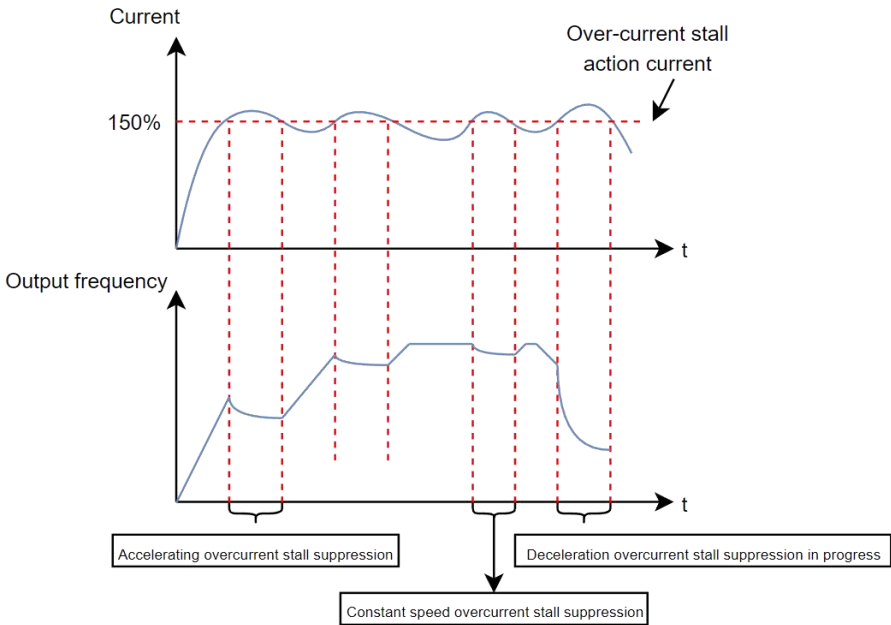

Figure 5-36 Overflow stall action diagram

At the same time, the KC200 defaults to the wave-by-wave current limiting (F13.04) function. For applications such as uneven load, instantaneous increase in load, or instantaneous disconnection and reconnection of the contactor connecting the AC drive and the motor, the current will have an instantaneous peak. Instantaneous

current spikes can be effectively suppressed through wave-by-wave current limiting.

Table 5-41 Over-current stall related parameters table

Parameter code (address)	Name	Content	Factory value (Setting range)
F13.00 (0x0D00)	Overcurrent stall suppression	0: Disabled 1: Enabled	1 (0~1)
F13.01 (0x0D01)	Overcurrent stall suppression action current	This parameter defines the percentage of overcurrent stall suppression action current threshold	150.0% (50%~200%)
F13.02 (0x0D02)	Overcurrent stall suppression gain	This parameter defines the gain of overcurrent stall suppression response	50 (0~100)
F13.03 (0x0D03)	Compensation coefficient of speed multiplying overcurrent stall suppression action current	Reduce the high-speed overcurrent stall suppression action current threshold	50 (50~200)
F13.04 (0x0D04)	Current protection Settings	Pulse-by-pulse current limit protection 0: Disabled 1: Enabled	1 (0~1)

5.7.4 Over-voltage control

When the bus voltage reaches the set value of over-voltage stall action voltage, the actual motor speed is greater than the motor speed corresponding to the output frequency of the frequency converter, and the motor is in the power generation state. In order to protect system safety and avoid tripping protection, the frequency converter activates the over-voltage stall protection function and increases the output frequency. The actual deceleration time will automatically extend. If the actual deceleration time cannot meet the system requirements, the over-excitation gain can be appropriately increased.

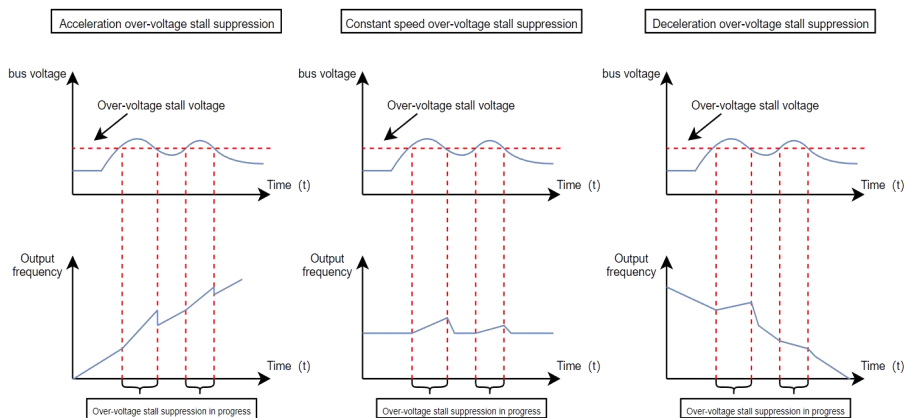

Figure 5-37 Overvoltage stall action diagram

Table 5-42 Overvoltage stall related parameter table

Parameter code (address)	Name	Content	Factory value (Setting range)
F05.14 (0x050E)	Over-excitation gain	This parameter defines the over-excitation gain, the larger the gain, the stronger the suppression effect	100 (0~200)

F05.16 (0x0510)	Oscillation suppression gain	By adjusting this value, low frequency resonance can be suppressed, but it can't be too large, otherwise it will cause additional stability problems	40 (0~200)
F13.10 (0x0D0A)	Overvoltage stall suppression	0: Disabled 1: Enabled	1 (0~1)
F13.11 (0x0D0B)	Overvoltage stall suppression action voltage	This parameter defines the V/f overvoltage stall suppression action voltage threshold	220Vmodel: 380.0V 380Vmodel: 750.0V 440Vmodel: 770.0V (200.0V~820.0V)
F13.12 (0x0D0C)	Overvoltage stall suppression frequency gain	Increase this value will improve the control effect of the bus voltage, but the output frequency will fluctuate	50 (0~100)
F13.13 (0x0D0D)	Overvoltage stall suppresses voltage gain	Suppress the bus voltage and increase this setting value can reduce the bus voltage overshoot	50 (0~100)
F13.14 (0x0D0E)	Frequency rise threshold for overvoltage stall suppression	Overvoltage stall suppression may increase the operating frequency. This parameter is the incremental upper limit of the operating frequency	5.00Hz (0~50.00Hz)
F13.17 (0x0D11)	Start voltage for actuating braking unit	The start voltage for actuating braking unit, used to adjust the brake resistance energy consumption efficiency	220Vmodel: 360.0V 380Vmodel: 700.0V 440Vmodel: 750.0V (200.0V~820.0V)

When using a braking resistor, installing a braking unit, or using an energy feedback unit, please note:

- Please set the F05.14 "over-excitation gain" value to "0", otherwise it may cause excessive current during operation.
- Please set the F13.10 "over-voltage stall enable" value to "0", otherwise it may cause the problem of prolonged deceleration time.

5.7.5 Under Voltage Control (Instant Stop Without Stopping)

The instant stop function allows the system to continue to operate during a short power outage. When the system has a power outage, the inverter makes the motor in the state of power generation, so that the bus voltage is maintained at the "instantaneous stop and non-stop operation judgment voltage", to prevent the AC drive from stopping due to the input voltage is too low, resulting in under-voltage failure, as shown in the following figure.

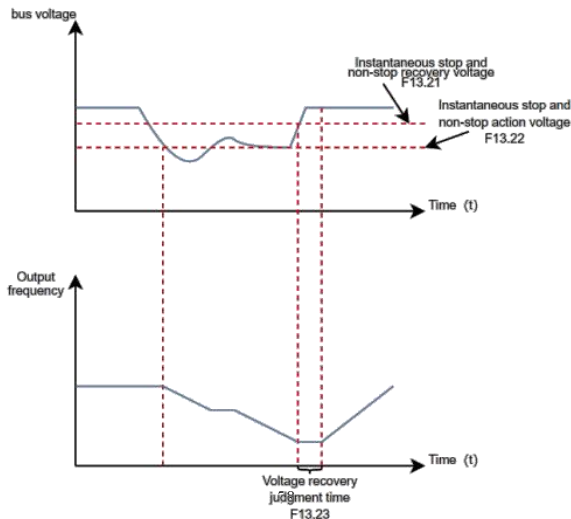

Figure 5-38 Schematic diagram of the instantaneous stop and non-stop process

When the "bus voltage constant control" mode is used, when the power grid resumes power supply, the output frequency of the frequency converter will recover to the target frequency according to the acceleration time.

When in the "deceleration shutdown" mode, when the power grid resumes power supply, the AC drive continues to decelerate to 0Hz and stops until the AC drive issues a start command again before starting the AC drive.

Table 5-43 Instantaneous non-stop related parameter table

Parameter code (address)	Name	Content	Factory value (Setting range)
F13.20 (0x0D14)	Power dip ride-through	This parameter defines whether the AC driver runs during instantaneous power failure 0: Disabled 1: Keep bus voltage constant 2: Decelerate to stop	0 (0~2)
F13.21 (0x0D15)	Voltage threshold for disabling power dip ride-through	This parameter defines the voltage threshold for disabling power dip ride-through of the AC driver, if voltage higher than this value, temporarily stop the adjustment	85.0% (80.0%~100.0%)
F13.22 (0x0D16)	Voltage threshold for enabling power dip ride-through	This parameter defines the voltage level at which the bus voltage is maintained upon power failure. Upon power failure, the bus voltage is maintained around F13.22 (voltage threshold for enabling power dip ride-through)	80.0% (60.0%~100.0%)
F13.23 (0x0D17)	Delay of voltage recovery from power dip	This parameter defines the time required for the bus voltage to rise from F13.21 (voltage threshold for disabling power dip ride-through) to the voltage before power failure	0.5s (0.0s~100.0s)
F13.24 (0x0D18)	Power dip ride-through gain Kp	This parameter is valid only in the "keep bus voltage constant" mode (F13.20 = 1). If undervoltage occurs frequently during power dip ride-through, increase the power dip ride-through gain and integral coefficient	50 (0~100)
F13.25 (0x0D19)	Power dip ride-through integral coefficient		30 (0~100)
F13.26 (0x0D1A)	Deceleration time of power dip ride-through	This parameter is valid only in the "decelerate to stop" mode (F13.20 = 2). When the bus voltage is lower than the value of F13.22, the AC drive decelerates to stop. The deceleration time is determined by this parameter but not F01.24	20.0s (0.0s~300.0s)

5.8 Introduction to application function

5.8.1 Frequency detection

5.8.1.1 Frequency detection (FDT)

Used to set the detection value of the output frequency and the hysteresis value of the output action release. The hysteresis value is only effective during deceleration, and the detection during acceleration does not lag. The frequency detection function is shown in the following figure.

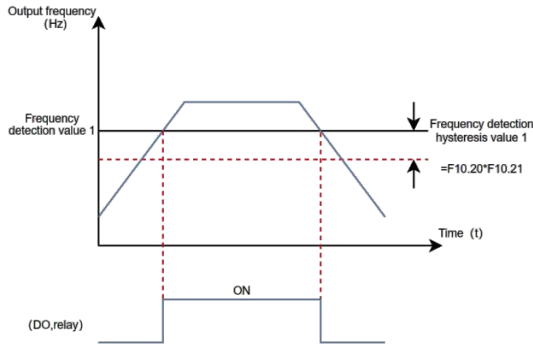

Figure 5-39 Frequency detection diagram

Table 5-44 Frequency detection related parameters table

Parameter code (address)	Name	Factory value (Setting range)	Description
F10.00 (0x0A00)	DO1 terminal function selection	2 (0~35)	15: Frequency level detection FDT1 output 16: Frequency level detection FDT2 output
F10.01 (0x0A01)	DO2 terminal function selection	2 (0~35)	
F10.02 (0x0A02)	RELAY relay function selection	8 (0~35)	
F10.03 (0x0A03)	RELAY1 relay function selection	0 (0~35)	
F10.20 (0x0A14)	Frequency detection value (FDT1)	5.00Hz (0.00Hz~F01.11)	When the operating frequency is higher than the frequency detection value (FDT1), the DO terminal outputs an effective signal; When the operating frequency is lower than the frequency detection value (FDT1) minus the frequency check lag value (FDT1), the DO terminal outputs an invalid signal. The set value is valid between 0.00Hz and F01.11 (maximum frequency).
F10.21 (0x0A15)	Frequency detection hysteresis value (FDT1)	0.0% (0.0%~100.0%)	The frequency detection lag value (FDT1) is F10.20 times F10.21. When the operating frequency is higher than F10.20, the DO terminal outputs an effective signal; When the operating frequency is below a specific value (F10.20 minus the product of F10.20 and F10.21), the DO terminal outputs an invalid signal.
F10.22 (0x0A16)	Frequency detection value (FDT2)	5.00Hz (0.00Hz~F01.11)	When the operating frequency is higher than the frequency detection value (FDT2), the DO terminal outputs an effective signal; When the operating frequency is lower than the frequency detection value

			(FDT2) minus the frequency detection delay value (FDT2), the DO terminal outputs an invalid signal. The set value is valid between 0.00Hz and F01.11(maximum frequency).
F10.23 (0x0A17)	Frequency detection hysteresis value (FDT2)	0.0% (0.0%~100.0%)	The frequency detection lag value (FDT2) is F10.22 times F10.23. When the operating frequency is higher than F10.22, the DO terminal outputs an effective signal; When the operating frequency is below a specific value (F10.22 minus the product of F10.22 and F10.23), the DO terminal outputs an invalid signal.

5.8.1.2 Frequency reaches detection amplitude

Set the detection range of frequency arrival through parameter F10.24, and the timing chart of frequency arrival detection amplitude is shown in the following figure.

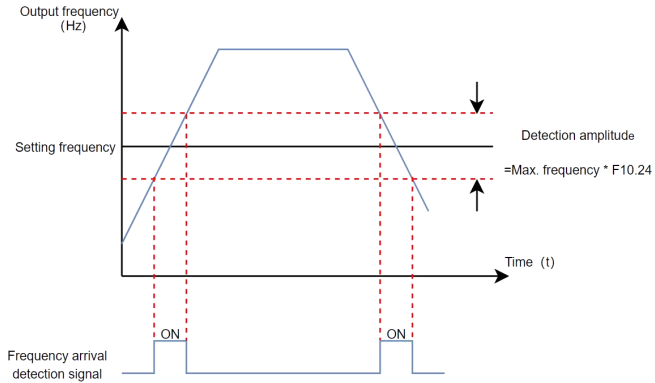

Figure 5-40 Frequency arrival detection amplitude timing chart

Table 5-45 Frequency arrival related parameter table

Parameter code (address)	Name	Factory value (Setting range)	Parameter Description
F10.00 (0x0A00)	DO1 terminal function selection	2 (0~35)	17: Frequency reaches output
F10.01 (0x0A01)	DO2 terminal function selection	2 (0~35)	
F10.02 (0x0A02)	RELAY relay function selection	8 (0~35)	
F10.03 (0x0A03)	RELAY1 relay function selection	0 (0~35)	
F10.24 (0x0A18)	Frequency reaches detection range	0.0% (0.0%~100.0%)	The detection amplitude value of frequency arrival is the product of F10.24 (frequency arrival detection amplitude) and F01.11 (maximum frequency). When the operating frequency of the AC drive is within a specific range (set frequency ± F10.24 * F01.11), the DO terminal outputs a valid signal.

5.8.1.3 Any arrival frequency detection value

When the operating frequency of the AC drive is within the range of any arrival frequency check value \pm any arrival frequency detection amplitude, the DO terminal outputs a valid signal.

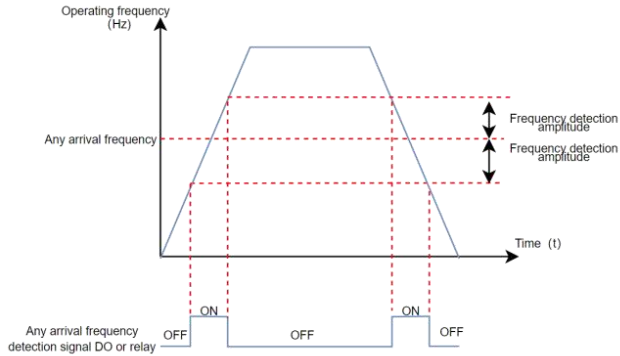

Figure 5-41 Schematic diagram of arbitrary arrival frequency detection

Table 5-46 Arrival Frequency Detection Related Parameters Table

Parameter code (address)	Name	Factory value (Setting range)	Parameter Description
F10.00 (0x0A00)	DO1 terminal function selection	2 (0~35)	22: Any frequency reaches the output
F10.01 (0x0A01)	DO2 terminal function selection	2 (0~35)	
F10.02 (0x0A02)	RELAY relay function selection	8 (0~35)	
F10.03 (0x0A03)	RELAY1 relay function selection	0 (0~35)	
F10.25 (0x0A19)	Arbitrary arrival frequency detection value	50.00Hz (0.00Hz~F01.11)	When the operating frequency of the AC drive is within the frequency detection range, the DO terminal outputs a valid signal. This setting is valid between 0.00Hz and F01.11 (maximum frequency).
F10.26 (0x0A1A)	Arbitrary arrival frequency detection amplitude	0.0% (0.0%~100.0%)	Frequency arrival detection amplitude 1 is F01.11 (maximum frequency) multiplied by F10.26, and the frequency detection range is F10.25 (frequency arrival detection value) plus or minus F10.26 (frequency arrival detection amplitude), that is: $(F10.25) \pm (F10.26) \times (F01.11)$

5.8.2 Current detection

5.8.2.1 Zero-current Detection

When the output current of the AC drive is less than or equal to the zero-current detection level (F10.29) and the duration exceeds the zero-current detection delay time (F10.30), the DO terminal outputs a valid signal.

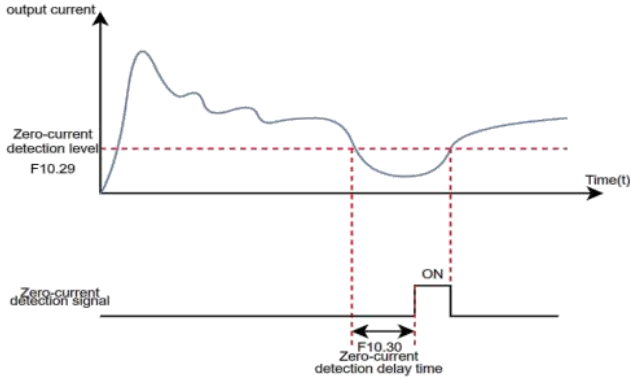

Figure 5-42 Zero current detection diagram

Table 5-47 Zero current detection related parameter table

Parameter code (address)	Name	Factory value (Setting range)	Parameter Description
F10.00 (0x0A00)	DO1 terminal function selection	2 (0~35)	7: Zero-current state
F10.01 (0x0A01)	DO2 terminal function selection	2 (0~35)	
F10.02 (0x0A02)	RELAY relay function selection	8 (0~35)	
F10.03 (0x0A03)	RELAY1 relay function selection	0 (0~35)	
F10.29 (0x0A1D)	Zero current detection level	5.0% (0.0%~300.0%)	When the output current of the AC drive is less than or equal to the zero current detection level F10.29 and the duration exceeds the zero current detection delay time F10.30, the DO terminal outputs a valid signal.
F10.30 (0x0A1E)	Zero current detection delay time	0.10s (0.01~600.00)	

5.8.2.2 Output current exceeding limit detection

When the output current of the AC drive exceeds the output current limit (F10.31) and the duration exceeds the output current limit detection delay time (F10.32), the DO terminal outputs a valid signal.

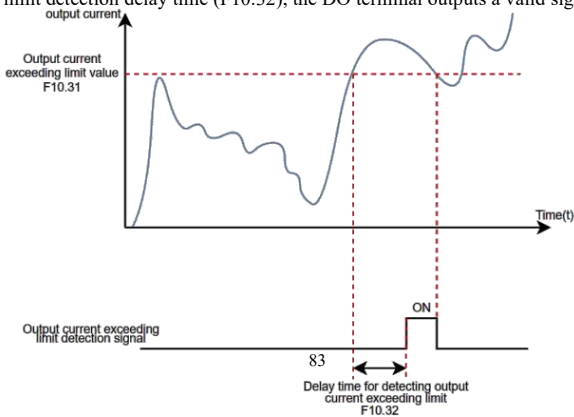

Figure 5-43 Schematic diagram of output current over-limit detection

Table 5-48 Output current over-limit detection related parameter table

Parameter code (address)	Name	Factory value (Setting range)	Parameter Description
F10.00 (0x0A00)	DO1 terminal function selection	2 (0~35)	30: Output current exceeds limit
F10.01 (0x0A01)	DO2 terminal function selection	2 (0~35)	
F10.02 (0x0A02)	RELAY relay function selection	8 (0~35)	
F10.03 (0x0A03)	RELAY1 relay function selection	0 (0~35)	
F10.31 (0x0A1F)	Output current exceeds limit value	200.0% (0.0%~300.0%)	When the output current of the AC drive is greater than F10.31 (output current exceeding the limit value) and the duration exceeds F10.32 (output current exceeding the limit detection delay time), the DO terminal outputs a valid signal.
F10.32 (0x0A20)	Output current over-limit detection delay time	0.01s (0.00~600.00)	

5.8.2.3 Arbitrary arrival current detection

When the output current of the frequency converter is within the range of (arbitrary reaching current $1 \pm$ arbitrary reaching current 1 width)*motor rated current range, the DO terminal outputs a valid signal.

KC200 provides a set of arbitrary arrival current and detection width parameters. The function diagram is shown in the figure below.

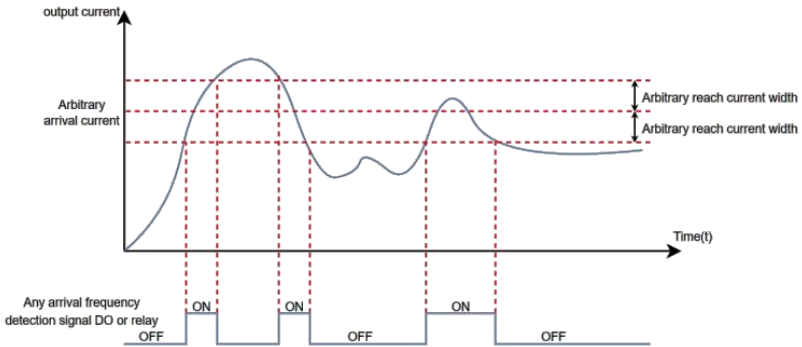

Figure 5-44 Arbitrary arrival current timing diagram

Table 5-49 Arbitrary current arrival detection related parameter table

Parameter code (address)	Name	Factory value (Setting range)	Parameter Description
F10.00 (0x0A00)	DO1 terminal function selection	2 (0~35)	23: Any current reaches the output
F10.01 (0x0A01)	DO2 terminal function selection	2 (0~35)	
F10.02 (0x0A02)	RELAY relay function selection	8 (0~35)	
F10.03 (0x0A03)	RELAY1 relay function selection	0 (0~35)	

F10.33 (0x0A21)	Arbitrary arrival current	100.0% (0.0%~300.0%)	When the output current of the AC drive is within the range of F10.33 (any arrival current) \pm F10.34 (any arrival current width) multiplied by F03.04 (motor rated current), the DO terminal outputs a valid signal.
F10.34 (0x0A22)	Arbitrary current width	0.0% (0.0%~300.0%)	The value of any reaching current width is F10.34 (any reaching current width) multiplied by F03.04 (motor rated current).

5.8.3 Forward and reverse instruction

5.8.3.1 Forward and reverse dead - time

The transition time at the output 0Hz during the forward and reverse transition process of the frequency converter is called the forward and reverse dead-band time (F02.27).

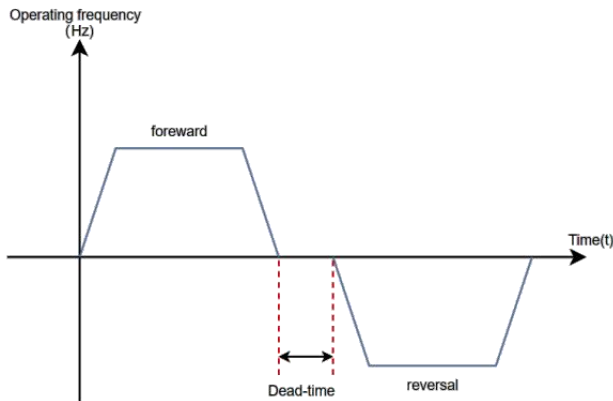

Figure 5-45 Forward and reverse dead time diagram

Table 5-50 Forward and reverse dead zone time related parameter table

Parameter code (address)	Name	Factory value (Setting range)	Parameter Description
F02.27 (0x021B)	Forward and reverse dead time	0.0s (0.0s~60000.0s)	Set the transition time at the output of 0Hz during the forward and reverse transition of the AC drive.

5.8.3.2 Reverse frequency prohibition and rotation direction selection

The reverse frequency prohibition is set through parameter F02.28. The reverse frequency prohibition diagram is as shown below:

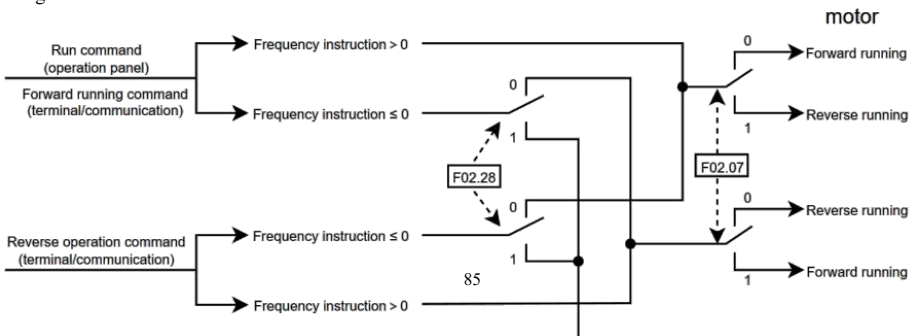

Figure 5-46 Reverse frequency prohibition diagram

Table 5-51 Reverse frequency prohibition related parameter table

Parameter code (address)	Name	Content	Factory value (Setting range)	Parameter Description
F02.28 (0x021C)	Reverse control enable	0: Allow Inversion 1: Prohibit inversion	0 (0~1)	When F02.28 is valid, input a reverse command to the frequency converter, and the motor runs at zero frequency.
F02.07 (0x0207)	Rotation direction	0: Consistent direction 1: Opposite direction	0 (0~1)	By changing this parameter, the purpose of changing the direction of motor rotation can be achieved without changing the motor wiring, which is equivalent to adjusting any two lines of the motor (U, V, W) to achieve the conversion of motor rotation direction.

The forward and reverse operation of the motor is set through parameter F02.07. By changing the F02.07 parameter, the purpose of changing the motor rotation direction can be achieved without changing the motor wiring. Its function is equivalent to adjusting any two lines of the motor (U, V, W) to achieve the conversion of the motor rotation direction.

Explanation: After parameter initialization, the motor's running direction will return to its original state. Be cautious when using in situations where it is strictly prohibited to change the motor direction after system debugging.

5.9 Introduction of auxiliary function

5.9.1 Hibernation and wakeup

Hibernation function is also known as sleep function. During sleep time, the AC drive stops running.

Wakeup is a process that the AC drive wakes up from the sleep state and starts to run.

Sleep and Wakeup require setting parameters such as wakeup frequency, hibernation frequency and hibernation time, respectively. Generally, the wakeup frequency (F12.00) should be higher than or equal to the hibernation frequency (F12.02). If the wakeup frequency and hibernation frequency are both 0.00Hz, the sleep and wake functions are disabled.

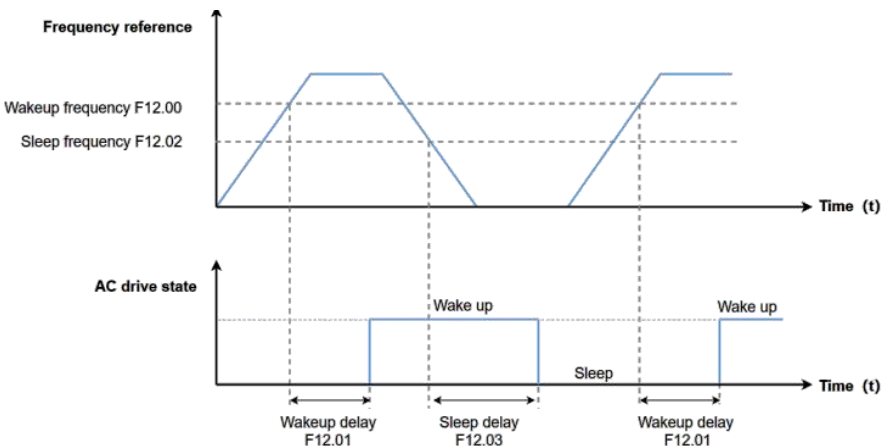

Figure 5-47 Sleep and wake-up function settings

Note: When PID is operating, the sleep function is enabled. If you want PID to continue operating, set F16.20 (PID stop operation) to 1 (stop operation); if you want PID to stop operation, set F16.20 (PID stop operation) Set to 0 (stop and no operation).

Table 5-52 Hibernation and wakeup Parameters

Parameter code (address)	Name	Factory value (Setting range)	Parameter Description
F12.00 (0x0C00)	Wakeup frequency	0.00Hz (F12.02~F01.11)	If the AC drive is in hibernation state and the current running command is effective, when the set frequency is greater than or equal to wakeup frequency(F12.00), after the wakeup delay time (F12.01), the AC drive starts directly.
F12.01 (0x0C01)	Wakeup delay	0.0s (0.0s~6500.0s)	
F12.02 (0x0B02)	Hibernation frequency	0.00Hz (0Hz~F12.00)	When the frequency reference is less than or equal to the hibernation frequency (F12.02) during running,the AC drive enters the hibernation state and stops after the hibernation delay time (F12.03).
F12.03 (0x0C03)	Hibernation delay	0.0s (0s~6500.0s)	

5.9.2 Swing frequency control function

Swing frequency function means that the AC drive output frequency swings up and down with the set frequency (frequency command selected by F01.04) as the center. The swing frequency function is suitable for textile, chemical fiber and other industries, as well as occasions that require traversing and winding functions.

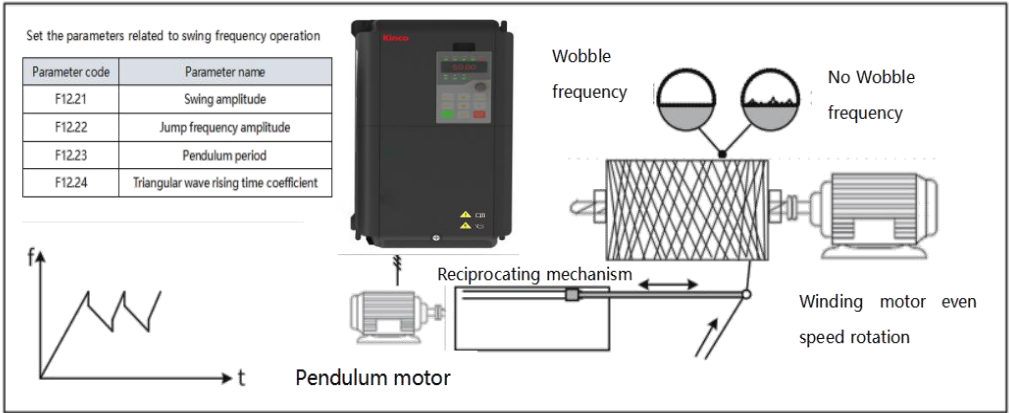

Figure 5-48 Swing frequency application scenario diagram

Figure 5-49 Swing frequency working diagram

Table 5-53 Swing frequency control related parameter table

Parameter code (address)	Name	Content	Factory value (Setting range)
F12.20 (0x0C14)	Swing frequency setting method	0: relative to center frequency 1: relative to maximum frequency	0 (0~1)
F12.21 (0x0C15)	Swing frequency amplitude	Set swing frequency amplitude	0.0% (0.0%~50.0%)
F12.22 (0x0C16)	Jump swing frequency amplitude	Set the sudden swing frequency amplitude	0.0% (0.0%~50.0%)
F12.23 (0x0C17)	Swing frequency period	Set the swing frequency period	10.0s (0.1s~6000.0s)
F12.24 (0x0C18)	Triangular wave rise time of swing frequency	Set the triangular wave rise time of the swing frequency	50.0% (0.1%~100.0%)

1. Calculation method of swing amplitude

When the swing amplitude setting mode F12.20=0 (relative to the center frequency), the swing amplitude AW = frequency command selection (F01.10) \times swing frequency amplitude (F12.21).

When the swing amplitude setting mode F12.20=1 (relative to the maximum frequency), the swing amplitude AW = maximum frequency (F01.11) \times swing frequency amplitude (F12.21).

2. Calculation method of sudden jump frequency

When running at swing frequency, the jump frequency is the relative swing value: that is: jump frequency = swing amplitude AW \times jump frequency amplitude (F12.22).

When the swing setting mode F12.20=0 (relative to the center frequency), the jump frequency is the change value.

When the swing setting mode F12.20=1 (relative to the maximum frequency), the jump frequency is a fixed value.

3. Triangular wave rising/falling time counting method

Triangular wave rising time = swing frequency period F12.23 \times triangular wave rising time coefficient F12.24 (unit: s)

Triangular wave falling time = swing frequency period F12.23 \times (1 - triangular wave rising time coefficient F12.24) (unit: s)

(Swing frequency period = triangular wave rising time + triangular wave falling time)

5.9.3 Fixed length function

With fixed length control function, length pulses can only be collected using the DI6 terminal, and the DI6 terminal function selection must be set to 45 (length counting input).

Table 5-54 Fixed-length function related parameter table

Parameter code (address)	Name	Content	Factory value (Setting range)
F12.12 (0x0C0C)	Set length	Set the maximum length counter value	10000 (1~65535)
F12.13 (0x0C0D)	Actual length	Set the current value of the length counter	10000 (1~65535)
F12.14 (0x0C0E)	pulses per meter	Set the number of pulses per meter of length	100.0 (0.1~6553.5)

In the figure below, the actual length is the monitored value, and the actual length (F12.13) = the number of

pulses sampled by the terminal / the number of pulses per meter (F12.14). When the actual length (F12.13) is greater than the set length (F12.12), the relay or DO output terminal "length arrival" ON signal (function selection is 27). During the fixed length control process, the length reset operation can be performed through the multi-function DI terminal (the DI function is set to 46). The specific settings are shown in the figure below.

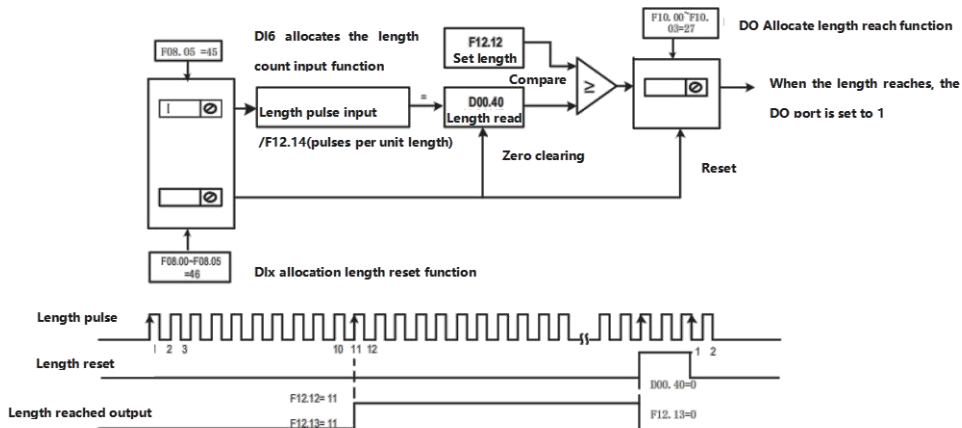

Figure 5-50 Fixed length function diagram

In fixed-length control mode, the direction cannot be identified, and the length can only be calculated based on the number of pulses. Feed back the T/AT/B output signal of the relay (RELAY) that reaches the length to the stop input terminal of the inverter to make an automatic stop system.

5.9.4 Timing function

When the AC drive starts each time, it starts timing from 0. After reaching the Timing duration (F12.30), the AC drive automatically stops, and the DO terminal (No.32 function) outputs an active signal. The remaining timing duration can be viewed through D00.56.

The DO terminal (No.33 function) outputs an active signal when the current running duration reaches the value of F12.31.

The DO terminal (No.34 function) outputs an active signal when the accumulative running duration reaches the value of F12.32. The accumulative running duration can be viewed through D00.57.

The DO terminal (No.35 function) outputs an active signal when the accumulative Power-on duration reaches the value of F12.33. The accumulative Power-on duration can be viewed through D00.58.

Table 5-55 Timing function related parameter table

Parameter code (address)	Name	Factory value (Setting range)	Parameter Description
F10.00 (0x0A00)	DO1 terminal function selection	2 (0~35)	32: Timed duration reach 33: Current running duration reach 34: Accumulative running duration reach 35: Accumulated power-on duration reach
F10.01 (0x0A01)	DO2 terminal function selection	2 (0~35)	
F10.02 (0x0A02)	RELAY relay function selection	8 (0~35)	
F10.03 (0x0A03)	RELAY1 relay function selection	0 (0~35)	

F12.30 (00x0C1E)	Scheduled running time	0 min (0min~6500.0min)	Used to set each running time of the inverter. Each time the inverter starts, the timing starts from 0. After reaching the scheduled running time (F12.30), the inverter automatically stops, and at the same time, the DO terminal (No. 32 function) outputs a valid signal.
F12.31 (0x0C1F)	Current running arrival time	0 min (0min~6500.0min)	Used to set the current running time of the inverter. If the current running time exceeds F12.31, the DO terminal (function 33) outputs a valid signal.
F12.32 (0x0C20)	Set cumulative running arrival time	0 h (0h~65000h)	Used to set the running time of the inverter. When D00.57 (accumulated running time) exceeds F12.31 (set cumulative power-on arrival time), the DO terminal (function No. 34) outputs a valid signal.
F12.33 (0x0C21)	Set the cumulative power-on arrival time	0 h (0h~65000h)	Used to set the power-on time of the inverter. When D00.58 (accumulated power-on time) exceeds F12.30 (set cumulative power-on arrival time), the DO terminal (function No. 35) outputs a valid signal.
F12.34 (0x0C22)	Positioning run time unit	0 (0~1)	Set the unit of F12.30 timing running time.

5.9.5 Counting function

The count value needs to be collected through the DI terminal (when the pulse frequency is high, the DI6 port must be used), and the DI terminal function is set to 043 (counter input).

In the figure below, the count value needs to be collected through the DI terminal, and the DI terminal function must be set to 43 (counter input). If the count value reaches the set count value (F12.10), the multi-function digital DO outputs the "set count value reached" ON signal; if the count value reaches the specified count value (F12.11), the multi-function digital DO outputs " Specified count value reaches "ON signal.

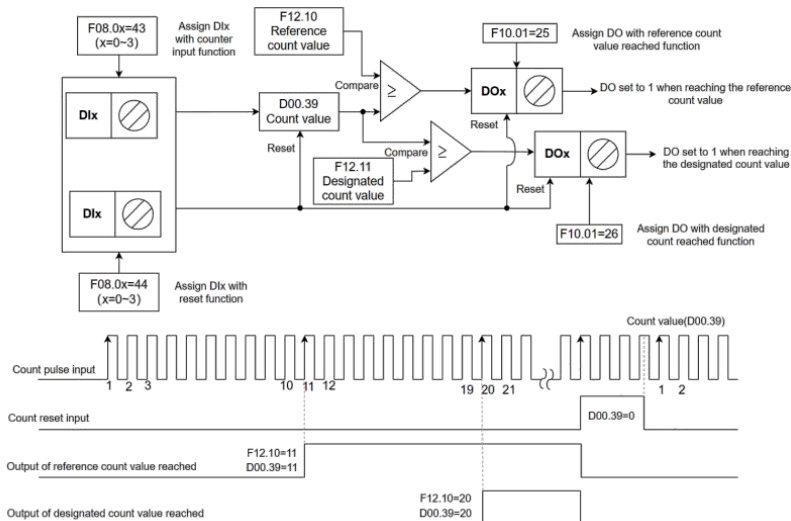

Figure 5-51 Counting function diagram

Table 5-56 Counting function related parameter table

Parameter Code (Address)	Name	Reference	Function Description
F08.00~F08.06 (Choose one)	DI1~DI6 terminal function selection (Choose one)	43	Counter input
F08.00~F08.06 (Choose one)	DI1~DI6 terminal function selection (Choose one)	44	Count reset
F10.01~F10.02 (Choose one)	Terminal output function selection (Choose one)	25	Set count value reached
F10.01~F10.02 (Choose one)	Terminal output function selection (Choose one)	26	The specified count value is reached

Notice:

1. When the pulse frequency is high, the DI6 port must be used;
2. " Set count reaches " and " The DO port whose count reaches " cannot be reused;
3. In the inverter RUN/STOP state, the counter will keep counting until " Set the count value " to stop counting when it reaches;
4. The count value can be retained after power failure;
5. Feeds back the output signal of the count reaching DO to the stop input terminal of the inverter to make an automatic shutdown system.

Table 5-57 Count value setting related parameter table

Parameter code (address)	Name	Content	Factory default (Setting range)
F12.10 (0x0B0A)	Set count value	Set the maximum counter value	10000 (1~65535)
F12.11 (0x0B0B)	Specify count value	Set the current count value of the counter	10000 (1~65535)

5.9.6 Simple PLC function

The simple PLC can complete the simple combined operation of multi-speed instructions, and has two functions: as a frequency source or as a voltage source with VF separation. When simple PLC is used as the frequency source, the ones digit of "PLC stage setting" determines the running direction, and the ones digit of F17.17 "Simple PLC operation mode" determines the three operation cycle modes in:

0: Stop after a single cycle The inverter automatically stops after completing a single cycle, and the running command needs to be given again to start.

1: Maintain the final value after a single cycle After the inverter completes a single cycle, it will automatically maintain the last segment of operation. frequency and direction.

2: Continuous cycle After the inverter completes one cycle, it will automatically start the next cycle until there is a stop command. time to stop.

The tens digit of F17.17 "Simple PLC operation mode" determines the timing unit of the PLC stage running time, while the hundreds and thousands digits of F17.17 determine the simple PLC power-off storage method and shutdown memory method respectively. PLC power-off storage refers to memorizing the operating stage and operating frequency of the PLC before power-off, and continuing to run from the memory stage when the power is turned on next time. If you choose not to remember, the PLC process will be restarted every time you power on. PLC shutdown memory records the previous running stage and running frequency of the PLC when it stops, and continues running from the memory stage the next time it runs. If you choose not to remember, the PLC process will be restarted every time it is started.

Table 5-58 Simple PLC Function-related parameter table

Parameter code (address)	Name	Content	Factory default (Setting range)
--------------------------	------	---------	---------------------------------

F17.17 (0x1111)	Simple PLC operation mode	Units digit: circular mode 0: Stop after a single cycle 1: Keep the final value after a single cycle 2: Continuous loop Tens place: timing unit 0: seconds (s) 1: Minutes (min) 2: hours (h) Hundreds digit: power-off storage method 0: Do not store 1: Storage Thousands digit: shutdown memory mode 0: No memory when stopping 1: Stop memory	0x0000 (0x0000~0x1122)
F17.19 (0x1113)	PLC segment 0 running time	Set the running time of PLC segment 0	0.0s(min/h) (0.0~ 6500.0s(min/h))
F17.20 (0x1114)	PLC phase 0 setup	Units digit: running direction of this section 0: Same direction 1: reverse Tens digit: acceleration and deceleration time of this section 0: Acceleration and deceleration time 1 (F01.23, F01.24) 1: Acceleration and deceleration time 2 (F01.25, F01.26) 2: Acceleration and deceleration time 3 (F01.27, F01.28) 3: Acceleration and deceleration time 4 (F01.29, F01.30)	0x00 (0x00~0x31)
F17.21 (0x1115)	PLC first stage running time	Same as F17.19	0.0s(min/h) (0.0~ 6500.0s(min/h))
F17.22 (0x1116)	PLC phase 1 setup	Same as F17.20	0x00 (0x00~0x31)
F17.23 (0x1117)	PLC second stage running time	Same as F17.19	0.0s(min/h) (0.0~ 6500.0s(min/h))
F17.24 (0x1118)	PLC stage 2 setup	Same as F17.20	0x00 (0x00~0x31)
F17.25 (0x1119)	PLC section 3 running time	Same as F17.19	0.0s(min/h) (0.0~ 6500.0s(min/h))
F17.26 (0x111A)	PLC stage 3 setup	Same as F17.20	0x00 (0x00~0x31)
F17.27 (0x111B)	PLC segment 4 running time	Same as F17.19	0.0s(min/h) (0.0~ 6500.0s(min/h))
F17.28 (0x111C)	PLC stage 4 setup	Same as F17.20	0x00 (0x00~0x31)
F17.29 (0x111D)	PLC section 5 running time	Same as F17.19	0.0s(min/h) (0.0~ 6500.0s(min/h))
F17.30 (0x111E)	PLC stage 5 setup	Same as F17.20	0x00 (0x00~0x31)
F17.31 (0x111F)	PLC section 6 running time	Same as F17.19	0.0s(min/h) (0.0~

			6500.0s(min/h))
F17.32 (0x1120)	PLC stage 6 setup	Same as F17.20	0x00 (0x00~0x31)
F17.33 (0x1121)	PLC segment 7 running time	Same as F17.19	0.0s(min/h) (0.0~ 6500.0s(min/h))
F17.34 (0x1122)	PLC stage 7 setup	Same as F17.20	0x00 (0x00~0x31)
F17.35 (0x1123)	PLC segment 8 running time	Same as F17.19	0.0s(min/h) (0.0~ 6500.0s(min/h))
F17.36 (0x1124)	PLC stage 8 setup	Same as F17.20	0x00 (0x00~0x31)
F17.37 (0x1125)	PLC section 9 running time	Same as F17.19	0.0s(min/h) (0.0~ 6500.0s(min/h))
F17.38 (0x1126)	PLC stage 9 setup	Same as F17.20	0x00 (0x00~0x31)
F17.39 (0x1127)	PLC 10th segment running time	Same as F17.19	0.0s(min/h) (0.0~ 6500.0s(min/h))
F17.40 (0x1128)	PLC stage 10 setup	Same as F17.20	0x00 (0x00~0x31)
F17.41 (0x1129)	PLC segment 11 running time	Same as F17.19	0.0s(min/h) (0.0~ 6500.0s(min/h))
F17.42 (0x112A)	PLC stage 11 setup	Same as F17.20	0x00 (0x00~0x31)
F17.43 (0x112B)	PLC segment 12 running time	Same as F17.19	0.0s(min/h) (0.0~ 6500.0s(min/h))
F17.44 (0x112C)	PLC stage 12 setup	Same as F17.20	0x00 (0x00~0x31)
F17.45 (0x112D)	PLC segment 13 running time	Same as F17.19	0.0s(min/h) (0.0~ 6500.0s(min/h))
F17.46 (0x112E)	PLC stage 13 setup	Same as F17.20	0x00 (0x00~0x31)
F17.47 (0x112F)	PLC segment 14 running time	Same as F17.19	0.0s(min/h) (0.0~ 6500.0s(min/h))
F17.48 (0x1130)	PLC stage 14 setup	Same as F17.20	0x00 (0x00~0x31)
F17.49 (0x1131)	PLC segment 15 running time	Same as F17.19	0.0s(min/h) (0.0~ 6500.0s(min/h))
F17.50 (0x1132)	PLC stage 15 setup	Same as F17.20	0x00 (0x00~0x31)

5.10 User password

Password Settings:

If F00.00 is set to a non-zero value (password protection is enabled), the parameter menu is accessible only after the correct password is entered. Password authentication is required every time you access the

parameter menu again.

Password cancellation:

Set F00.00 to 0, which cancels the user password protection.

5.11 Parameter initialization and upload-download

5.11.1 Initialize (restore default Setting)

Set F00.04 to 01 or 02, you can restore all parameters to their default Settings, and after initialization, F00.04 returns to 0.

Table 5-59 Parameter initialization F00.04 function table

F00.04 (Value Range)	Content	Instructions
1	Restore default settings (excluding motor parameters)	The following parameters cannot be restored to default values: <ul style="list-style-type: none"> ● Motor parameters ● Fault record information ● IGBT heatsink temperature (D00.14) ● Accumulative running duration (D00.58) ● Accumulative power-on duration (D00.57) ● Accumulative power consumption (D00.59,D00.60)
2	Restore default settings (including motor parameters)	The following parameters cannot be restored to factory values: <ul style="list-style-type: none"> ● IGBT heatsink temperature (D00.14) ● Accumulative running duration (D00.58) ● Accumulative power-on duration (D00.57) ● Accumulative power consumption (D00.59,D00.60)
3	Clear fault records	Clear the following parameters: <ul style="list-style-type: none"> ● Fault records (D01 group) ● Accumulative running duration (D00.58), Accumulative power consumption (D00.59) ● Accumulative power consumption (D00.59,D00.60)

5.11.2 Upload and download

When the AC drive is connected to the external keyboard, all current parameters can be uploaded to the external keyboard storage space for backup or copying by setting the function code F00.05 to 1. You can download the parameters back to the frequency converter or copy them to another device by setting F00.06 to 1 or 2.

Table 5-60 Upload and download select parameter table

Parameter code (address)	Name	Content	Defaults (Value range)	Parameter description
F00.05 (0x0005)	Parameter upload	0: None Operation 1: Parameters uploaded to keyboard storage space	0 (0~1)	Upload the current parameters to the external keyboard, and set to 0 automatically after uploading;
F00.06 (0x0006)	Parameter download	0: No operation 1: Download parameters from Keyboard storage space (excluding motor parameters) 2: Download parameters from Keyboard storage space (including motor parameters)	0 (0~2)	The value in the storage space of the external keyboard is downloaded back to the AC drive, and automatically set to 0 after the download is completed;

5.12 Fault and protection

5.12.1 Startup protection

By setting F02.08 to 1, startup protection is enabled to prevent the motor from responding to a command upon unexpected power-on or fault reset of the AC drive.

The startup protection works in the following two scenarios:

If a command is issued upon power-on of the AC drive (for example, the terminal used as the command source are ON before power-on), the AC drive does not respond to the command. Instead, the AC drive responds only after the command is revoked and re-issued.

If a command is issued upon fault reset of the AC drive, the AC drive does not respond to the command. Instead, the AC drive responds only after the command is revoked and re-issued.

Table 5–61 Startup protection selection parameter table

Parameter code (address)	Name	Content	Defaults (Value Range)	Parameter description
F02.08 (0x0208)	Start protection selection	0: No protection 1: Protection	0 (0~1)	The inverter has a built-in starting protection function, which can prevent the danger caused by the motor responding to the running command during power-on or fault reset without knowing it.

5.12.2 Undervoltage/Overvoltage threshold

Table 5–62 Undervoltage point and overvoltage point setting parameter table

Parameter Code (address)	Name	Content	Defaults (Value Range)	Parameter description
F13.29 (0x0D1D)	Undervolt age point setting	When the bus voltage is lower than the setting value of F13.29, the inverter reports a fault.	220V model: 200.0V 380V model: 350.0V 440V model: 350.0V (150.0V to 700.0V)	When the bus voltage exceeds the overvoltage point, E0004~E0006 overvoltage faults are reported. When the bus voltage is lower than the undervoltage point, E0007 undervoltage fault during operation is reported.
F13.19 (0x0D13)	Overvoltage point setting	Set bus overvoltage threshold	220V model: 400.0V 380V model: 820.0V 440V model: 820.0V (350.0V to 820.0V)	

5.12.3 Phase loss protection

Table 5–63 Phase loss setting parameter table

Parameter Code (address)	Name	Content	Defaults (Value Range)	Parameter description
F13.34 (0x0D22)	Input phase loss protection selection	Input phase loss protection selection 0: Input phase loss fault is prohibited 1: Enable input phase loss fault	11 (00~11)	KC200 inverter does not detect the input voltage. For three-phase 220V and 380V models, it determines whether the input phase is missing by detecting the ripple of the bus voltage. Therefore, when the input phase is missing, a phase missing fault will only be reported when a certain load is added.
F13.35 (0x0D23)	Enter phase loss detection level	Enter phase loss detection level	10% (5~50%)	

F13.36 (0x0D24)	Enter the phase loss detection time	Enter the phase loss detection time	10ms (5~2000ms)	
F13.37 (0x0D25)	Output phase loss detection selection	Units digit: Output phase loss detection Tens digit: Output phase loss detection before operation 0: invalid 1: valid	01 (00~11)	Units digit: Select whether to protect the output phase loss. If you select 0, a fault will not be reported when the output phase loss actually occurs. At this time, the actual current is larger than the current displayed on the panel, which is risky. Use with caution. Tens digit: It takes about a few seconds to detect output phase loss during operation. For situations where there is a risk of starting after phase loss or low-frequency operation, enabling this function can quickly detect whether there is an output phase loss during starting, but it is not suitable for starting. It is recommended not to enable this function in situations where time is strictly required.

5.12.4 Fault resetting

The undervoltage fault (E0007) is automatically reset when the bus voltage resumes normal, and the reset is not included in the auto reset count. The short-to-ground fault (E0010) cannot be reset automatically or manually, only through the AC drive completely power off, and then reset after powering on again. Fault protection action selection is required when the set number of fault auto reset times is reached.

Table 5-64 Fault reset parameter table

Parameter code (address)	Name	Content	Defaults (Set range)	Parameter description
F13.60 (0x0D3C)	Auto reset attempts	Number of automatic resets	0 (0 ~ 20)	This parameter defines the maximum number of auto resets allowed for the AC drive when the fault protection action is set to auto reset. If the number of reset attempts exceeds the value of this parameter, the AC drive will remain in the faulty state. note: The undervoltage fault (E0007) is automatically reset when the bus voltage resumes normal, and the reset is not included in the auto reset count.

F13.61 (0x0D3D)	DO action during auto reset	0: Disabled 1: Enabled	0 (0 ~ 1)	During the automatic reset of the inverter fault, whether the fault output function of the digital output terminal is effective. The fault output power of the digital output terminal is defined by F10.01=8.
F13.62 (0x0D3E)	Auto reset interval	the waiting time after a fault	1.0 s (0.1s ~ 100.0s)	The waiting time between the frequency converter fault alarm and the automatic fault reset.

5.12.5 Fault action protection selection

Table 5-65 Fault action protection parameter table

Parameter code (address)	Name	Content	Factory Defaults (Set range)
F13.65 (0x0D41)	Fault protection action selection 1	Ones : Input phase loss Tens : Output phase loss Hundreds: reserved Thousands: reserved Ten thousands: Load loss 0: Coast to stop 1: Decelerate to stop 2: Continue to run	00000 (0 ~ 20022)
F13.66 (0x0D42)	Fault protection action selection 2	Ones : External fault Tens : Communication exception Hundreds: EEROM Communication exception Thousands: PID feedback loss Ten thousands: reserved 0: Coast to stop 1: Decelerate to stop 2: Continue to run	00000 (0 ~ 02222)
F13.67 (0x0D43)	Fault protection action selection 3	Ones : Accumulative running duration reach Tens : Accumulative power-on duration reach Hundreds: User-defined fault Thousands: reserved Ten thousands: reserved 0: Coast to stop 1: Decelerate to stop 2: Continue to run	00000 (0~ 00222)

6 Troubleshooting

6.1 Common Faults and Diagnosis

6.1.1 Alarm and Fault Display

When the AC drive fails, the fault alarm display screen appears in the operation panel, and the fault relay acts, the AC drive stops the output, and the motor stops freely.
 For example: "E0001" accelerated overcurrent error, ALM light flashing.
 The following figure shows the fault display screen:



Figure 6-1 Interface fault display



Do not repair or modify the AC drive by yourself. In case of any fault that cannot be rectified, contact the agent or Kinco for technical support.

6.1.2 Restart upon faults

Table 6-1 Restart upon fault

Stages	Treatment Measures	Instructions
When a fault occurs	View the last three fault types, fault frequency/current / voltage / bus voltage / inverter temperature / input / output terminal status / power and running time through the operation panel display	View it through the D01 group.
Before fault reset	Locate and rectify the fault cause based on the fault code displayed on the operating panel.	If the fault cannot be removed or the fault cause is not clear, please contact the manufacturer directly.
Method of fault reset	Set the DI to function 16(F08.00~F08.03=16 fault reset), and make the terminal valid, reset the fault.	Serious faults such as ground short circuit fault, contactor overload fault and repeated hardware overcurrent cannot be reset directly reset, and must be reset by method 4.
	Reset by the STOP  key in the operator panel. Use a host controller for reset (for communication control mode). Verify that F01.03=2 (communication control mode) and write "0008" (fault reset) to the communication address 7000H by using the host controller.	

	Power off and then power on the AC drive for automatic reset. Disconnect the main circuit power supply and reconnect the power supply after the display on the operating panel disappears.	All faults caused by device damage or short circuit to ground of external output can be reset by this method.
--	---	---

6.1.3 Common troubleshooting

Table 6-2 Common faults and solutions

Serial Number	Fault symptoms	Possible cause	Solutions
1	Digital tube does not display, the inverter does not start	The grid voltage is not input or too low	Check the input power supply
		The switched-mode power supply (SMPS) on the drive board of the AC drive is faulty	Check whether the 24 V output voltage and 10 V output voltage on the control board are normal
		The frequency converter buffer resistance is damaged	Contact Kinco.
		Control board, keyboard failure	
		The buffer resistor of the AC drive is damaged	
		The control board or operating panel is faulty	
The rectifier bridge is damaged.			
2	"E0010" alarm is displayed upon power-on.	The motor or output cable is shorted to ground.	Measure the insulation of the motor and output lines with universal
		AC drive damage	Seek manufacturer service Contact Kinco.
3	The motor does not rotate when the AC drive is running.	The AC drive and motor are incorrectly connected.	Double check the connection between the AC drive and motor
		Related AC drive parameters (motor parameters) are set incorrectly.	Restore the AC drive to factory settings and reset the following parameters correctly
			Check F01.03(Running Command Channel) and set it correctly
			V/f mode, heavy load start, adjust F05.07(torque boost) parameter or F05.12 and F05.13 (on-line torque compensation gain)
4	DI terminals are inactive.	Related parameters are set incorrectly	Check and set parameters in group F08 again
		External signal transmission errors occur	Re-connect external signal cables
		The control board is faulty	Contact Kinco
5	The motor coasts to stop, or braking is disabled during deceleration or deceleration to stop	overvoltage stall protection is enabled	If a braking resistor is configured, set F13.10=0 to disable overvoltage stall suppression
6	The AC drive reports overcurrent and overvoltage frequently	Motor parameters are incorrectly set.	Adjust motor parameters or perform motor auto-tuning again.
		The acceleration/deceleration time is improper.	Set acceleration/deceleration time properly
		The load fluctuates.	Contact Kinco

7	E0026 (inverter over temperature) is reported frequently.	The load frequency setting is too high or fails to automatically reduce the load frequency according to the temperature rise	Lower load frequency (F01.40) enables automatic lower load frequency (F01.41=1) according to the temperature rise
		The fan is damaged, or the air filter is blocked.	Replace the fan or clean the air filter.
		Components (thermistor or other devices) inside the AC drive are damaged.	Contact Kinco

6.1.4 Different control mode under trial operation treatment countermeasures

6.1.4.1 V/F Control Mode(VF control is not recommended for synchronous motor)

V/F control mode (F01.02=0, factory default value), this mode is used in applications where the motor does not have encoder speed feedback. It is not sensitive to motor parameters. It only needs to correctly set the rated voltage and rated voltage of the motor. frequency value.

Table 6-3 V/F Countermeasures in control mode

Problem	Solution
Motor oscillation during running	Decrease the value of F05.16 (V/f oscillation suppression gain) by increments of 5. The minimum value is 5.
The current is too large in the operation	<ul style="list-style-type: none"> ● Set F03.03 (rated motor voltage) and F03.054 (rated motor frequency) correctly. ● Decrease the value of F05.07 (torque boost) by increments of 0.5%.
The motor is loud	Increase the value of F01.40 (carrier frequency) by increments of 1.0 kHz. Note that an increase in the carrier frequency will result in an increase in the leakage current of the motor.
Sudden increased load overcurrent, accelerated overcurrent	<ul style="list-style-type: none"> ● Increase the drain velocity gain (F13.02) by 10; ● reduce the velocity current (F13.01) by 10%.
Overload report and deceleration report overpressure	<ul style="list-style-type: none"> ● Confirm that the overvoltage stall enabling force (F13.10) is set to the enabling state; ● Reduce the overvoltage action voltage (F13.11) in 10V. ● Increase the overvoltage stall gain (F13.12/F13.13), increase in 10;

6.1.4.2 Vector control mode

Vector control mode (F01.02=1 open loop vector control, F01.02=2 closed loop vector control), the control mode is to control the speed and torque of the motor. In this control mode, it is necessary to self-learn the motor parameters and complete the automatic setting of motor parameters

Table 6-4 Countermeasures in open-loop vector control mode

Problems	Solution
Overload or overcurrent reported during motor startup	According to the motor nameplate Perform motor auto-tuning (by setting F03.09). Dynamic auto-tuning on all parameters of the motor is preferred when possible
Slow torque or speed response and motor vibration at frequencies below 5 Hz	<ul style="list-style-type: none"> ● In the case of slow motor torque or speed response, increase the value of F06.00 (speed loop proportional gain) by increments of 10 or decrease the value of F06.01 (speed loop integral time) by decrements of 0.05; ● In the case of motor vibration, decrease the value of F06.00 and increase the value of F06.01.
Slow torque or speed response and motor vibration at frequencies above 5 Hz	<ul style="list-style-type: none"> ● In the case of slow motor torque or speed response, increase the value of F06.02 (speed loop proportional gain) by increments of 10 or decrease the value of F06.03 (speed loop integral time) by decrements of 0.05; ● In the case of motor vibration, decrease the value of F06.02 and increase the value of F06.03.
Low speed accuracy	In the case of excessive speed deviation during with-load operation, increase the value of F06.06 (vector control slip compensation gain) by increments of 10%.

Large speed fluctuation	In the case of abnormal motor speed fluctuation, increase the value of F06.07 (speed filter time) by increments of 1ms.
Loud motor noise	Increase the value of F01.40 (carrier frequency) by increments of 1.0 kHz. Note that an increase in the carrier frequency will result in an increase in the leakage current of the motor.
Insufficient motor torque or insufficient output	Check whether the torque upper limit is set too low. If yes, increase the value of F06.12 (torque upper limit) in speed control mode or increase the torque reference in torque control mode.

6.2 List of fault codes

The following faults may occur during the use of the AC drive. Troubleshoot the faults according to the solutions described in the following table.

Table 6-5 Fault code

Fault name	Operation panel display	Troubleshoot the cause of the failure	Troubleshooting countermeasures
Accelerate over current	E0001	Ground or short circuit in the converter output circuit	Check the motor or interrupt contactor for a short circuit.
		Manual torque lift or V /F curve is inappropriate for control mode for V/F	Adjust the manual lift torque or V/F curve.
		The control mode is SVC without parameter tuning	Set the motor parameters according to the motor nameplate and tune the motor parameters.
		Rapid acceleration condition, the acceleration time is set is too short	Increase the acceleration time (F01.23).
		Excessive loss rate suppression is not set properly	<ul style="list-style-type: none"> ● Verify that the flow suppression function (F13.00) is enabled; ● the flow current (F13.01) is too high; ● the flow suppression gain (F13.02) is too small.
		If the load increases instantly or connects, the contactor connected to the motor is suddenly disconnected and reengaged	Enabling the wave-limiting function (F13.04=1).
		No brake resistance is installed	Install the brake resistance.
Decelerating overcurrent	E0002	Externally disturbed	Through the historical fault record, check whether the current value reaches overcurrent during the fault. If not reached, it is external interference, and the external interference source is checked to remove the fault. After investigation if there is no external interference source, it may be the drive plate or Hall device damage, and you need to contact the manufacturer for replacement.
		The output circuit of the inverter is grounded or short-circuited	Detect the motor for short circuit or open circuit.
		The control mode is SVC and no parametric tuning is performed	Set motor parameters according to motor nameplate and perform motor parameter tuning.
		Under rapid deceleration condition, the deceleration time is set too short	Increase deceleration time (F01.24).

		Excessive loss rate suppression is not set properly	<ul style="list-style-type: none"> Confirm that over loss rate suppression (F13.00) is enabled; Over loss quick acting current (F13.01) set value is too large; Over loss speed suppression gain (F13.02) is set too small.
		The load is increased instantaneously or the contactor connected to the motor is suddenly disconnected and re-drawn	Enable wave by wave current limiting (F13.04)
		No brake resistance added	Brake resistors are installed.
		Subject to external interference	Based on the historical fault records, check whether the current value during the fault reaches the overcurrent. If it does not reach the current value, it is judged that it is external interference. It is necessary to troubleshoot the external interference sources and remove the fault. If no external interference source is found, the driver board or Hall component may be damaged, and you need to contact the manufacturer to replace it.
Constant speed overcurrent	E0003	Ground or short circuit in the converter output circuit	Check the motor for a short circuit or open circuit.
		The control mode is SVC without parameter tuning	Set the motor parameters according to the motor nameplate and tune the motor parameters.
		Excessive loss rate suppression is not set properly	<ul style="list-style-type: none"> Verify that the suppression function (F13.00) is enabled; the current (F13.01) is too high; the gain (F13.02) is too small.
		If the load increases instantly or connects, the contactor connected to the motor is suddenly disconnected and reengaged	Enabling the wave-limiting function (F13.04=1).
		The selection of frequency converter is too small	In the stable running state, if the operating current has exceeded the rated current of the motor or the rated output current value of the frequency converter, please choose the frequency converter with a larger power level.
		Externally disturbed	Through the historical fault record, check whether the current value reaches overcurrent during the fault. If not reached, it is external interference, and the external interference source is checked to remove the fault. If there is no external interference source after investigation, it may be that the drive plate or Hall device is damaged, and contact the manufacturer for replacement.
Accelerated overvoltage	E0004	The input grid voltage is high	Adjust the voltage to the normal range.
		External force drags the motor during the acceleration process	Cancel the external force or install brake resistance.

		The overvoltage suppression setting is not appropriate	Verify that the overvoltage suppression function (F13.10) is enabled; the overvoltage (F13.11) is too high; the overvoltage suppression frequency gain (F13.12) is too small.
		No brake unit and brake resistance are installed	Install the brake unit and the resistance.
		The acceleration time is too short	Increase the acceleration time (F01.23).
Slow down overvoltage	E0005	The overvoltage suppression setting is not appropriate	Verify that the overvoltage suppression function (F13.10) is enabled; the overvoltage (F13.11) is too high; the overvoltage suppression frequency gain (F13.12) is too small.
		External force drags the motor during the deceleration process	Cancel the external force or install brake resistance.
		The deceleration time is too short	Increase the deceleration time.
		No brake unit and brake resistance are installed	Install the brake unit and the resistance.
Constant speed overvoltage	E0006	The overvoltage suppression setting is not appropriate	Verify that the overvoltage suppression function (F13.10) is enabled; the overvoltage (F13.11) is too high; the overvoltage suppression frequency gain (F13.12) is too small.
		There is an external force dragging the motor during the operation	Cancel the external force or install brake resistance.
Undervoltage fault	E0007	Instantaneous power failure	The instantaneous stop function (F13.20) can prevent the instantaneous power failure and undervoltage failure.
		The input voltage of the inverter is not in the range required by the specification	Adjust the voltage to the normal range.
		Bus voltage is abnormal	Looking for technical support.
		Rectifier part, the inverter drive board, the inverter control board is abnormal	Looking for technical support.
Short-circuit fault between output phases	E0009	Short-circuit fault between output phases	Replace and check the cable or motor for three phase short circuit.
Short-circuit to the ground fault	E0010	Motor short circuit to ground	Replace and check the cable or motor for a short circuit to the ground.
Current detection fault	E0011	The frequency converter current sampling is abnormal	Check the main circuit for power-up.
		The frequency converter current sampling is abnormal	The Hall sensor is damaged, the current sampling current is damaged, contact the manufacturer.
Wave by wave limiting fault	E0012	Whether the load is too large or the motor blocked	Reduce the load and check the motor and mechanical condition.
		The selection of frequency converter is too small	Choose the frequency converter with a larger power level.
Motor tuning fault	E0013	Motor parameters are not set according to the nameplate	Set the motor parameters correctly according to the nameplate.
		Parameter identification process has timed out	Check the inverter to the motor leads.
Input phase loss	E0014	Three-phase input power supply is abnormal	Check the input RST wiring and three-phase input voltage.

		The input phase detection level and detection time are too small	Increase the input phase absence detection level (F13.35) and the input phase absence detection time (F13.36) appropriately.
		Drive plate, lightning protection board, main control board, rectifier bridge are abnormal	Looking for technical support.
Output phase loss	E0015	Motor failure	Check whether the motor is open circuit.
		The lead from the frequency converter to the motor is not normal	Troubleshoot the peripheral faults.
		The three-phase output of the frequency converter is unbalanced during the motor operation	Check whether the three-phase winding of the motor is correct and troubleshooting.
		Drive board, IGBT module is abnormal	Looking for technical support.
Buffer resistance overload fault	E0018	Repeated bus voltage undervoltage recovery	Check the input power supply.
Frequency converter overload	E0023	Whether the motor protection parameter F13.41 is set properly	Set this parameter correctly and increase F13.41 to extend the motor overload time.
		Whether the load is too large or the motor blocked	Reduce the load and check the motor and mechanical condition.
Motor overload	E0024	Whether the motor protection parameter F13.41 is set properly	Set this parameter correctly and increase F13.41 to extend the motor overload time.
		Whether the load is too large or the motor blocked	Reduce the load and check the motor and mechanical condition.
The load failure	E0025	The operating current of the frequency converter is less than F13.44	Check whether the load is detached or whether the parameter settings of F13.44 and F13.45 meet the actual operating conditions.
The module overheating	E0026	The ambient temperature is too high	Reduce the ambient temperature.
		The air duct is blocked	Clean the air duct.
		Fan damage	Change the fan.
		The module thermistor is damaged	Looking for technical support.
		Module damage	Looking for technical support.
External equipment failure	E0028	Enter the external fault through the multifunctional terminal DI	Check for peripheral faults, confirm that the machine allows re-starting, and check whether the starting protection is enabled (F02.08), and reset the operation.
Communication failure	E0029	The upper computer is not working properly	Check the upper machine wiring.
		The communication line is not normal	Check the communication cable.
		Communication parameter F14 group was not set incorrectly	Set the communication parameters correctly.
		Other reasons	Try to restore the factory settings.

EEPROM Read-write fault	E0030	EEPROM Chip is damaged	Contact Kinco.
Run-time PID feedback loss fault	E0031	PID feedback greater than F16.27 set value	Check the PID feedback signal or set F16.27 as an appropriate value.
		PID feedback less than F16.28 set value	Check the PID feedback signal or set F16.28 as an appropriate value.
During the cumulative operation, the fault is reached in between operations	E0032	The cumulative running time has reached the set point	Clear the record information by using the parameter initialization function.
The accumulated power-on time reaches the fault	E0033	The cumulative power-on time reaches the set value	Clear the record information by using the parameter initialization function.
User-defined fault	E0034	Enter the signal of the user-defined fault through the multifunctional terminal DI	Change the corresponding terminal level status or cancel the custom fault, and reset the operation.
Encoder fault	E0040	The encoder is not working properly	Seek technical support.
		The encoder is not connected properly	Check the encoder cable.
		Encoder parameter F04 group is set incorrectly	Set encoder parameters correctly.
Excessive speed deviation and large fault	E0041	Parameter tuning was not performed	Conduct motor parameter tuning.
		The detection parameters F13.52 and F13.53 are not set properly	Set the detection parameters reasonably according to the actual situation.
Motor overspeed fault	E0042	Encoder parameter F04 group is set incorrectly	Set encoder parameters correctly.
		Parameter tuning is not performed	Perform motor parameter tuning.
		Motor overspeed detection parameters F13.50 and F13.51 are set improperly	Set detection parameters reasonably according to the actual situation.
Synchronous motor back electromotive force identification error	E0060	Motor parameters are set incorrectly (rated frequency, rated speed, rated voltage, etc.)	Set motor parameters correctly according to motor nameplate.
		Back electromotive force identification process motor oscillation	Adjust the loop parameters when tuning properly

7 Quick list of function parameters

7.1 Parameter terminology description

Table 7-1 Terminology and descriptions of control mode

Terminology	Content
Changeable at any time	Parameters that can be modified while running
Changeable only at stop	Parameters that cannot be modified while running
Unchangeable	This parameter can only be read, not modified

7.2 Parameters list

Table 7-2 Types of parameters of this product

Parameters	Name	Parameters	name
F00.00	User password	F09.2x-F09.3x	AI Curve
F00.02	Menu Mode Selection	F10.0x	DO Output functions
F00.04-F00.06	Parameter initialization	F10.1x	DO Delay
F01.0x-F01.1x	Basic instructions	F10.20-F10.26	Frequency detection
F01.2x-F01.3x	Acceleration and deceleration parameters	F10.29-F10.35	Current detection
F01.4x	Carrier parameters	F11.0x-F11.1x	AO Terminal function parameters
F02.0x	Start commands	F12.0x	Hibernation function parameters
F02.1x	Speed tracking command	F12.3x	Timing function parameters
F02.2x	Stop instructions	F13.0x	Current protection parameters
F02.30- F02.35	Jogging instruction	F13.1x-F13.2x	Voltage protection parameters
F02.37- F02.40	Skip frequency	F13.33-F13.35	Phase loss protection parameters
F03.0x	Motor parameters	F13.4x	Load protection parameter
F03.1x	Asynchronous motor parameters	F13.5x	Speed deviation protection parameters
F03.2x	Synchronous motor parameters	F13.60-F13.62	Fault reset
F05.00-F05.06	V/f curve	F13.65-F13.67	Failsafe action selection
F05.07-F05.08	Torque boost	F14.0x	Communication parameter
F05.09-F05.14	Slip compensation	F15.0x	Display parameter function selection
F05.15-F05.16	Oscillation suppression	F15.1x	Run/Stop display parameters
F05.2x	V/f separation	F16.0x-F16.3x	PID parameters
F06.0x-F06.1x	Speed loop parameters	F17.00-F17.15	Multi-reference parameter
F07.0x	Current loop parameters	F18	Extended terminal parameter
F08.0x-F08.1x	DI Terminal function	F19	Communication mapping parameter
F08.2x	High speed pulse frequency	D00.0x-D00.5x	Basic monitoring
F08.3x	DI Filtering time	D01	Fault monitoring
F08.4x	DI Delay time	D02.0x-D02.1x	System Info
F09.0x-F09.1x	AI Basic parameters		

7.3 Group F00: Environmental applications

Parameter (address)	Name	Reference	Default (Setup range)	Adjustable properties
F00.00 (0x0000)	User password	This parameter defines the user password	0 (0~65535)	Changeable at any time
F00.02 (0x0002)	Menu mode selection	0: Standard menu 1: Verification menu	0 (0~1)	Changeable at any time

F00.03 (0x0003)	Function group display selection	Units place: Group A display selection 0: Do not display 1: display	0x00001 (0x00000~0x00001)	Changeable at any time
F00.04 (0x0004)	Parameter initialization	0: No operation 1: Restore some factory parameters (excluding motor parameters, fault records, power-on time and other parameters) 2: Restore all factory parameters (restore all except manufacturer parameters) 3: Clear fault records	0 (0~3)	Changeable only at stop
F00.05 (0x0005)	Parameter upload	0: No operation 1: Upload parameters to keyboard storage space	0 (0~1)	Changeable only at stop
F00.06 (0x0006)	Parameter download	0: No operation 1: Download keyboard storage space parameters (excluding motor parameters) 2: Download keyboard storage space parameters (including motor parameters)	0 (0~2)	Changeable only at stop

7.4 Group F01: Basic parameters group

Parameter (address)	Name	Reference	Default (Setup range)	Adjustable properties
F01.01 (0x0101)	Motor selection	0: Motor 1 1: Motor 2	0 (0~1)	Changeable only at stop
F01.02 (0x0102)	Motor 1 control method	0: V/F control 1: Speed sensorless vector control (SVC) 2: Speed sensor vector control (FVC)	0 (0~2)	Changeable only at stop
F01.03 (0x0103)	Run command channel	0: Keyboard command channel 1: Terminal command channel 2: Communication command channel	0 (0~2)	Changeable only at stop
F01.04 (0x0104)	Main frequency given source channel X	0: Keyboard digital given frequency (F01.10) 1: AI1 given 2: AI2 given 3: AI3 given 4: Keyboard potentiometer given 5: Communication given 6: PULSE pulse given (DI6) 7: PID given 8: Multi-speed command 9: Simple PLC	0 (0~9)	Changeable only at stop

F01.05 (0x0105)	Auxiliary frequency given source channel Y	0: Keyboard digital given frequency (F01.10) 1: AI1 given 2: AI2 given 3: AI3 given 4: Keyboard potentiometer given 5: Communication given 6: PULSE pulse setting (DI6) 7: PID given 8: Multi-speed command 9: Simple PLC	0 (0~9)	Changeable only at stop
F01.06 (0x0106)	Frequency source channel Y reference source	0: Take the maximum output frequency as the reference source 1: Take the given frequency of channel X as the reference source	0 (0~1)	Changeable only at stop
F01.07 (0x0107)	Gain of auxiliary frequency source Y	This parameter defines gain of auxiliary frequency source Y.	100.0% (0.0~150.0%)	Changeable at any time
F01.08 (0x0108)	Frequency source superposition	Ones: Frequency source selection 0: Main frequency source X 1: Main and auxiliary operation result (based on the tens) 2: Switchover between main frequency source X and auxiliary frequency source Y 3: Switchover between main frequency source X and main and auxiliary operation result 4: Switchover between auxiliary frequency source Y and main and auxiliary operation result Tens: Main and auxiliary frequency source operation 0: Main + Auxiliary 1: Main - Auxiliary 2: Max. (main, auxiliary) 3: Min. (main, auxiliary)	0 (00~34)	Changeable only at stop
F01.09 (0x0109)	Frequency source bound to the command source	Ones: Frequency source bound to operating panel control Tens: Frequency source bound to terminal I/O control Hundreds: Frequency source bound to communication control 0: No binding 1 : Operating panel digital setting(F01.10) 2: AI1 given 3: AI2 given 4: AI3 given 5: Keyboard potentiometer given 6: Communication given 7: PULSE pulse setting (DI6) 8: PID given 9: Multi-speed command A: Simple PLC	0x000 (0x000~0xAAA)	Changeable only at stop
F01.10 (0x010A)	Keyboard number given frequency	Set keyboard number given frequency value	50.00Hz (0.00Hz~F01.11)	Changeable at any time

F01.11 (0x010B)	Maximum frequency	Set the inverter to limit the maximum output frequency	50.00Hz (50.00~ 600.00Hz)	Changeable only at stop
F01.12 (0x010C)	Upper limit frequency source selection	0: Digital setting (F01.13) 1: AI1 given 2: AI2 given 3: AI3 given 4: Keyboard potentiometer given 5: Communication given 6: PULSE pulse setting (DI6)	0 (0~6)	Changeable only at stop
F01.13 (0x010D)	Upper limit frequency	When the motor is not allowed to run above a certain frequency, limit the maximum operating frequency.	50.00Hz (F01.14~F01.11)	Changeable only at stop
F01.14 (0x010E)	Lower limit frequency	When the motor is not allowed to operate below a certain frequency, limit the minimum operating frequency.	0.00Hz (0.00Hz~F01.13)	Changeable only at stop
F01.15 (0x010F)	Frequency command resolution	1:0.1Hz 2:0.01Hz Note: After changing this parameter, all parameters involving the frequency will be restored to the factory value, including the motor rated frequency .	2 (1~2)	Changeable only at stop
F01.16 (0x0110)	Runtime frequency command UP/DOWN benchmark	0: given frequency 1: Set frequency	0 (0~1)	Changeable only at stop
F01.17 (0x0111)	Retention of digital setting of frequency	Ones: Stop retention selection 0: Non-retention 1: Retention Tens: Power down retention selection 0: Non-retention 1: Retention	0 (00~11)	Changeable at any time
F01.20 (0x0114)	Acceleration/Deceleration curve selection	0: Linear acceleration/deceleration 1: S-curve acceleration/deceleration	0 (0~1)	Changeable only at stop
F01.21 (0x0115)	Base value of the acceleration / deceleration	0: Relative to the maximum frequency 1: Relative to the setting frequency	0 (0~1)	Changeable only at stop
F01.22 (0x0116)	Acceleration time unit	0:1 s 1:0.1s	1 (0~1)	Changeable only at stop
F01.23 (0x0117)	Acceleration time 1	Acceleration time 1 of output frequency from 0.00Hz to F01.21	5.5KW (220V: 3.7KW) and below: 10.0s 11KW~45KW (220V: 5.5KW~22KW): 20.0s 55KW (220V: 30KW) and above: 50.0s (0.0s~6000.0s)	Changeable at any time
F01.24 (0x0118)	Deceleration time 1	Deceleration time 1 of output frequency from F01.21 to 0.00Hz		Changeable at any time
F01.25 (0x0119)	Acceleration Time 2	Acceleration time 2 of output frequency from 0.00Hz to F01.21		Changeable at any time
F01.26 (0x011A)	Deceleration Time 2	Deceleration time 2 of output frequency from F01.21 to 0.00Hz		Changeable at any time
F01.27 (0x011B)	Acceleration Time 3	Acceleration time 3 of output frequency from 0.00Hz to F01.21		Changeable at any time
F01.28 (0x011C)	Deceleration time 3	Deceleration time 3 of output frequency from F01.21 to 0.00Hz		Changeable at any time
F01.29 (0x011D)	Acceleration time 4	Acceleration time 4 of output frequency from 0.00Hz to F01.21		Changeable at any time

F01.30 (0x011E)	Deceleration time 4	Deceleration time 4 of output frequency from F01.21 to 0.00Hz		Changeable at any time
F01.31 (0x011F)	Time proportion of S-curve acceleration start segment	This parameter defines the acceleration start S-curve time proportion	30.00% (0.0%~ (100.0%-F01.32))	Changeable only at stop
F01.32 (0x0120)	Time proportion of S-curve acceleration end segment	This parameter defines the acceleration end S-curve time proportion	30.00% (0.0%~ (100.0%-F01.31))	Changeable only at stop
F01.33 (0x0121)	Time proportion of S-curve deceleration start segment	This parameter defines the deceleration start S-curve time proportion	30.00% (0.0%~ (100.0%-F01.34))	Changeable only at stop
F01.34 (0x0122)	Time proportion of S-curve deceleration end segment	This parameter defines the deceleration end S-curve time proportion	30.00% (0.0%~ (100.0%-F01.33))	Changeable only at stop
F01.35 (0x0123)	Switching frequency between acceleration time 1 and acceleration time 2	This parameter defines the switching frequency between acceleration time 1 and acceleration time 2	0.00Hz (0.00Hz~F01.11)	Changeable at any time
F01.36 (0x0124)	Switching frequency between deceleration time 1 and acceleration time 2	This parameter defines the switching frequency between deceleration time 1 with deceleration time 2	0.00Hz (0.00Hz~F01.11)	Changeable at any time
F01.40 (0x0128)	Carrier frequency	This parameter defines the switching frequency of the IGBT	11KW (220V: 5.5KW) and below: 6KHz 15KW~55KW (220V: 7.5KW~ 30KW): 4KHz 75KW (220V: 37KW) and above: 2KHz (0.5kHz~12.0kHz)	Changeable only at stop
F01.41 (0x0129)	Carrier automatic update basis	Ones: Adjust with temperature 0: Does not adjust with the temperature 1: Adjust with the temperature Tens: Adjust with frequency (VF control only) 0: Does not adjust with frequency 1: Adjust with frequency	0x11 (0x00~0x11)	Changeable only at stop

7.5 Group F02: Start/Stop control parameters

Parameter (address)	Name	Reference	Default (Setup range)	Adjustable properties
F02.00 (0x0200)	Startup mode	0: Direct start 1: Pre-excitation start 2: Speed tracking start	0 (0~2)	Changeable at any time
F02.01 (0x0201)	Startup frequency	This parameter defines the output startup frequency	0.00Hz (0.00Hz~20.00Hz)	Changeable at any time
F02.02 (0x0202)	Startup frequency hold time	This parameter defines the start frequency hold time for the output	0.0s (0.0s~100.0s)	Changeable only at stop
F02.03 (0x0203)	DC braking current at startup	This parameter defines the DC braking current for starting	0% (0%~150%)	Changeable only at stop

F02.04 (0x0204)	DC braking time at startup	This parameter defines the DC braking time for starting	0.0s (0.0s~100.0s)	Changeable only at stop
F02.07 (0x0207)	Rotation direction	0: Same 1: Opposite	0 (0~1)	Changeable only at stop
F02.08 (0x0208)	Startup protection	0: Not protected 1: Protected	0 (0~1)	Changeable only at stop
F02.10 (0x020A)	Speed tracking mode	Ones: Speed tracking search method 0: From the stop frequency 1: From 50Hz 2: From the maximum frequency	0 (0~2)	Changeable only at stop
F02.11 (0x020B)	Demagnetization time	After the motor stops, there is residual magnetism. You need to wait for this time before starting again	1.00s (0.00s~9.99s)	Changeable at any time
F02.12 (0x020C)	Speed tracking current	This parameter defines the value of speed tracking current	100% (20%~200%)	Changeable at any time
F02.13 (0x020D)	Speed tracking time	This parameter defines the value of speed tracking time	30 (1~200)	Changeable at any time
F02.14 (0x020E)	Speed tracking current loop KP	This parameter defines the proportional gain of the speed tracking current loop	500 (0~2000)	Changeable at any time
F02.15 (0x020F)	Speed tracking current loop KI	This parameter defines the integral coefficient of the speed tracking current loop	500 (0~2000)	Changeable at any time
F02.20 (0x0214)	Stop mode	0: Decelerate to stop 1: Coast to stop	0 (0~1)	Changeable at any time
F02.23 (0x0217)	Start frequency of DC braking at stop	The AC drive starts DC braking when the running frequency decreases to the value of this parameter during deceleration to stop	0.00Hz (0.00Hz~F01.11)	Changeable at any time
F02.24 (0x0218)	DC braking delay at stop	When the running frequency decreases to the start frequency of DC braking at stop, the AC drive stops output and starts DC braking after this waiting time.	0.0s (0.0s~100.0s)	Changeable at any time
F02.25 (0x0219)	Stop DC braking current	Set the parking DC braking current. The greater the current, the greater the braking force.	0% (0%~150%)	Changeable at any time
F02.26 (0x021A)	Stop DC braking time	Set stop DC braking holding time	0.0s (0.0s~100.0s)	Changeable at any time
F02.27 (0x021B)	Forward and reverse dead time	Set the transition time at output 0Hz during forward and reverse switching.	0.0s (0.0s~60000.0s)	Changeable at any time
F02.28 (0x021C)	Inversion control enable	0: Allow reversal 1: Disable reversal	0 (0~1)	Changeable only at stop
F02.29 (0x021D)	The set frequency is lower than the lower limit frequency operation mode	0: Run at the lower limit frequency 1: Stop in F02.20 mode 2: Zero speed operation	0 (0~2)	Changeable at any time
F02.30 (0x021E)	Jogging operating frequency	Set the operating frequency in jog operation mode	5.00Hz (0.00Hz~F01.11)	Changeable at any time
F02.31 (0x021F)	Jog acceleration time	Set the acceleration time in jog operation mode	10.0s (0.1s~6000.0s)	Changeable at any time

F02.32 (0x0220)	Jog deceleration time	Set the deceleration time in jog operation mode	10.0s (0.1s~6000.0s)	Changeable at any time
F02.33 (0x0221)	Jog acceleration and deceleration curve selection	0: Linear acceleration and deceleration 1: S-curve acceleration and deceleration	0 (0~1)	Changeable only at stop
F02.35 (0x0223)	Click priority	0:Invalid 1: valid	0 (0~1)	Changeable at any time
F02.36 (0x0224)	Is the jump frequency valid during acceleration and deceleration?	0: Invalid 1: valid	0 (0~1)	Changeable at any time
F02.37 (0x0225)	Jump frequency 1	Set jump frequency 1	0.00Hz (0.00Hz~F00.11)	Changeable at any time
F02.38 (0x0226)	Jump frequency 1 amplitude	Set jump frequency 1 amplitude	0.00Hz (0.00Hz~5.00Hz)	Changeable at any time
F02.39 (0x0227)	Jump frequency 2	Set jump frequency 2	0.00Hz (0.00Hz~F00.11)	Changeable at any time
F02.40 (0x0228)	Jump frequency 2 amplitude	Set jump frequency 2 amplitude	0.00Hz (0.00Hz~5.00Hz)	Changeable at any time

7.6 Group F03: Motor parameters

Parameter (address)	Name	Reference	Default (Setup range)	Adjustable properties
F03.00 (0x0300)	Motor type selection	0: Asynchronous motor 1: Synchronous motor	0 (0~1)	Changeable only at stop
F03.02 (0x0302)	Rated motor power	This parameter defines the rated power of the motor	Model settings (0.1kW~1000.0kW)	Changeable only at stop
F03.03 (0x0303)	Rated motor voltage	This parameter defines the rated voltage of the motor	Model settings (1V~500V)	Changeable only at stop
F03.04 (0x0304)	Rated motor current	This parameter defines the rated current of the motor	Model settings (0.01A~6000.0A)	Changeable only at stop
F03.05 (0x0305)	Rated motor frequency	This parameter defines the rated frequency of the motor	Model settings (0.01Hz~F01.11)	Changeable only at stop
F03.06 (0x0306)	Rated motor speed	This parameter defines the rated speed of the motor	Model settings (1~65535rpm)	Changeable only at stop
F03.09 (0x0309)	Motor parameters auto-tuning	0: No operation 1: Static auto-tuning(some parameters) 2: Rotating auto-tuning (all parameters)	0 (0~2)	Changeable only at stop
F03.10 (0x030A)	Asynchronous motor stator resistance	This parameter defines the DC resistance of the asynchronous motor stator winding	Model settings (0.0001~65.535 Ω)	Changeable only at stop
F03.11 (0x030B)	Asynchronous motor rotor resistance	This parameter defines the DC resistance of the asynchronous motor rotor winding	Model settings (0.0001~65.535 Ω)	Changeable only at stop
F03.12 (0x030C)	Asynchronous motor leakage inductance	This parameter defines the asynchronous motor leakage inductance	Model settings (0.001~655.35mH)	Changeable only at stop
F03.13 (0x030D)	Asynchronous motor mutual inductance	This parameter defines the asynchronous motor mutual inductance	Model settings (0.01~6553.5mH)	Changeable only at stop
F03.14 (0x030E)	Asynchronous motor no-load current	This parameter defines the current passing through the three-phase stator winding of an asynchronous motor during no-load operation	Model settings (0.01A~F03.04)	Changeable only at stop

F03.20 (0x0314)	Synchronous motor stator resistance	This parameter defines the DC resistance of the synchronous motor stator winding	Model settings (0.0001~65.535 Ω)	Changeable only at stop
F03.21 (0x0315)	Synchronous motor d- axis inductance	Set the synchronous motor d-axis inductance	Model settings (0.001~655.35mH)	Changeable only at stop
F03.22 (0x0316)	Synchronous motor q- axis inductance	Set the synchronous motor q-axis inductance	Model settings (0.001~655.35mH)	Changeable only at stop
F03.23 (0x0317)	Synchronous motor back electromotive force	Set the synchronous motor back electromotive force	Model settings (0.1~6553.5V)	Changeable only at stop
F03.24 (0x0318)	Encoder installation angle	Set the synchronous motor encoder installation angle	Model settings (0.0—359.9°)	Changeable only at stop
F03.25 (0x0319)	Initial position detection current	Set the initial position detection current	80% (50~150%)	Changeable only at stop
F03.26 (0x031A)	Initial position detection selection	0: Detect before each run 1: No detect 2: First power on operation detection	0 (0~2)	Changeable only at stop

7.7 Group F04: Motor 1 encoder parameters

Parameter (address)	Name	Reference	Default (Setup range)	Adjustable properties
F04.00 (0x0400)	Speed feedback encoder type	0: ABZ incremental encoder 1: UW encoder 2: Rotary transformer encoder	0 (0~2)	Changeable only at stop
F04.01 (0x0401)	Encoder line number	Set the number of encoder lines	1024 (1~20000)	Changeable only at stop
F04.02 (0x0402)	Encoder direction	0: Same direction 1: Opposite direction	0 (0~1)	Changeable only at stop
F04.03 (0x0403)	Gear ratio molecule	Set the gear ratio molecule	1 (1~32767)	Changeable only at stop
F04.04 (0x0404)	Gear ratio denominator	Set the gear ratio denominator	1 (1~32767)	Changeable only at stop
F04.06 (0x0406)	Encoder pulse cutoff frequency	Set the encoder pulse cutoff frequency	200KHz (50~500KHz)	Changeable only at stop
F04.10 (0x040A)	Encoder disconnection detection time	Set the encoder disconnection detection time	1.00s (0.10s~10.00s)	Changeable only at stop

7.8 Group F05: V/f control parameters

Parameter (address)	Name	Reference	Default (Setup range)	Adjustable properties
F05.00 (0x0500)	V/f curve	0: Linear V/f curve 1: Custom V/f curve 2: 1.2 power V/f curve 4: 1.4 power V/f curve 6: 1.6 power V/f curve 8: 1.8 power V/f curve 10: Square V/f curve 11: V/f full separation mode 12: V/f half separation pattern	0 (00~12)	Changeable only at stop
F05.01 (0x0501)	Multi-point V/f voltage V1	This parameter defines the multi-point V/f voltage V1	0.0% (0.0%~100.0%)	Changeable only at stop

F05.02 (0x0502)	Multi-point V/f frequency F1	This parameter defines the multi-point V/f frequency F1	0.00Hz (0.00Hz~F05.04)	Changeable only at stop
F05.03 (0x0503)	Multi-point V/f voltage V2	This parameter defines the multi-point V/f voltage V2	0.0% (0.0%~100.0%)	Changeable only at stop
F05.04 (0x0504)	Multi-point V/f frequency F2	This parameter defines the multi-point V/f frequency F2	0.00Hz (0.00Hz~F05.06)	Changeable only at stop
F05.05 (0x0505)	Multi-point V/f voltage V3	This parameter defines the multi-point V/f voltage V3	0.0% (0.0%~100.0%)	Changeable only at stop
F05.06 (0x0506)	Multi-point V/f frequency F3	This parameter defines the multi-point V/f frequency F3	0.00Hz (F05.04~F01.11)	Changeable only at stop
F05.07 (0x0507)	Torque boost	Under low frequency conditions, by setting this parameter to increase the output voltage of the frequency converter, the current is increased to improve the output torque (0.0%:Automatic torque boost)	Motor Power 5.5KW and below: 2.0% 7.5KW and above: 1.0% (0.0%~30.0%)	Changeable at any time
F05.08 (0x0508)	Cut-off frequency of torque boost	This parameter defines the effective range of the torque boost function. When the output frequency exceeds this value, the torque boost function is terminated.	20.00Hz (0.00Hz~F01.11)	Changeable at any time
F05.09 (0x0509)	Slip compensation gain	This parameter defines the slip compensation gain	0.0% (0.0%~200.0%)	Changeable at any time
F05.10 (0x050A)	Slip compensation limit	This parameter defines the slip compensation limit value (rated slip)	200.0% (0.0%~200.0%)	Changeable at any time
F05.11 (0x050B)	Slip compensation filter time	The slip compensation function requires correct input of motor nameplate parameters and parameter auto-tuning to achieve the best results	0.100s (0.000~1.000s)	Changeable at any time
F05.12 (0x050C)	Online torque compensation gain 1	This parameter defines the online torque compensation gain 1	130 (100~150)	Changeable at any time
F05.13 (0x050D)	Online torque compensation gain 2	This parameter defines the online torque compensation gain 2	100 (50~150)	Changeable at any time
F05.14 (0x050E)	Over-excitation gain	This parameter defines the over-excitation gain, the larger the gain, the stronger the suppression effect	100 (0~200)	Changeable at any time
F05.15 (0x050F)	Oscillation suppression mode	0: Invalid 1 to 4: Mode 1 to 4	1 (0~4)	Changeable at any time
F05.16 (0x0510)	Oscillation suppression gain	By adjusting this value, low frequency resonance can be suppressed, but it can't be too large, otherwise it will cause additional stability problems	40 (0~200)	Changeable at any time
F05.20 (0x0514)	Voltage source for V/f separated	0: Digital setting (F05.21) 1: All given 2: AI2 given 3: AI3 given 4: Keyboard potentiometer given 5: Communication given 6: PULSE pulse setting (DI6) 7: PID given 8: Multi-speed command 9: Simple PLC	0 (0~9)	Changeable at any time

F05.21 (0x0515)	V/f separation voltage	This parameter defines the V/f separation output voltage	0V (0V~F03.03)	Changeable at any time
F05.22 (0x0516)	Voltage acceleration time of V/f separation	This parameter defines the V/f separation voltage acceleration time	0.0s (0.0s~1000.0s)	Changeable at any time
F05.23 (0x0517)	Voltage deceleration time of V/f separation	This parameter defines the V/f separation voltage deceleration time	0.0s (0.0s~1000.0s)	Changeable at any time
F05.24 (0x0518)	Stop mode of V/f separation	0: Frequency and voltage decline to 0 independently 1: The frequency declines to 0 after voltage declines to 0	0 (0~1)	Changeable at any time
F05.30 (0x051E)	VF energy saving control	0: disables energy saving control 1: Automatic energy saving control 2: Manual energy saving control The load changes frequently. Use energy saving control with caution	0 (0~2)	Changeable at any time
F05.31 (0x051F)	VF energy saving coefficient	Manual energy-saving control, set the energy-saving control coefficient, the smaller the value, the more obvious the energy-saving effect, but the sudden load speed drop will be larger	50.0% (20.0%~100.0%)	Changeable at any time
F05.32 (0x0520)	VF Energy saving control KP	Set the proportional gain of VF energy saving control voltage regulation	500 (0~2000)	Changeable at any time
F05.33 (0x0521)	VF Energy saving control KI	Set the integral coefficient of VF energy saving control voltage regulation	500 (0~2000)	Changeable at any time

7.9 Group F06: Speed loop and torque control parameters

Parameter (address)	Name	Reference	Default (Setup range)	Adjustable properties
F06.00 (0x0600)	Low speed speed loop proportional gain	Set low speed speed loop proportional gain	40 (1~500)	Changeable at any time
F06.01 (0x0601)	Low speed speed loop integration time	Set low speed speed loop integration time	0.20s (0.01s~5.00s)	Changeable at any time
F06.02 (0x0602)	High speed speed loop proportional gain	Set high-speed speed loop proportional gain	20 (1~500)	Changeable at any time
F06.03 (0x0603)	High speed speed loop integration time	Set the high-speed speed loop integration time	0.40s (0.01s~5.00s)	Changeable at any time
F06.04 (0x0604)	Switch frequency 1	Set speed loop switching frequency 1	5.00Hz (0.00Hz~F06.05)	Changeable at any time
F06.05 (0x0605)	Switching frequency 2	Set speed loop switching frequency 2	10.00Hz (F06.04~F01.11)	Changeable at any time
F06.06 (0x0606)	Slip compensation gain	Set slip compensation gain	100% (50%~200%)	Changeable at any time
F06.07 (0x0607)	Speed feedback filter time	Set speed feedback filter time	15ms (5~100ms)	Changeable at any time
F06.08 (0x0608)	Speed loop integral separation	0: No separation 1: Integral separation	0 (0~1)	Changeable only at stop
F06.10 (0x060A)	Torque lock selection under speed control	0: Not locked 1: The electric power generation torque lock is the setting channel of F06.11	0 (0~1)	Changeable only at stop

F06.11 (0x060B)	Torque upper limit source under speed control (electric)	0: Digital setting (F06.12) 1: AI1 given 2: AI2 given 3: AI3 given 4: Keyboard potentiometer given 5: Communication given 6: PULSE pulse setting (DI6)	0 (0~6)	Changeable only at stop
F06.12 (0x060C)	Torque upper limit setting under speed control (electric)	Set the upper limit of torque under speed control (electric)	180.0% (0.0%~300.0%)	Changeable at any time
F06.13 (0x060D)	Torque upper limit source under speed control (power generation)	0: Digital setting (F06.14) 1: AI1 given 2: AI2 given 3: AI3 given 4: Keyboard potentiometer given 5: Communication given 6: PULSE pulse setting (DI6)	0 (0~6)	Changeable only at stop
F06.14 (0x060E)	Torque upper limit setting under speed control (power generation)	Set the upper limit of torque under speed control (power generation)	180.0% (0.0%~300.0%)	Changeable at any time
F06.30 (0x061E)	Torque control selection	0: Speed control 1: Torque control	0 (0~1)	Changeable only at stop
F06.31 (0x061F)	Torque setting source selection	0: Digital setting (F06.32) 1: AI1 given 2: AI2 given 3: AI3 given 4: Keyboard potentiometer given 5: Communication given 6: PULSE pulse setting (DI6)	0 (0~6)	Changeable only at stop
F06.32 (0x0620)	Torque digital setting	Set keyboard digital given torque	0.0% (-300.0%~300.0%)	Changeable at any time
F06.34 (0x0622)	Torque acceleration time	Set torque acceleration time	1.00 (0.00~600.00s)	Changeable at any time
F06.35 (0x0623)	Torque deceleration time	Set torque deceleration time	1.00 (0.00~600.00s)	Changeable at any time
F06.38 (0x0626)	Speed limit source selection	0: Digital limit (F06.39 and F06.40) 1: Upper limit frequency limit 2: AI1 given 3: AI2 given 4: AI3 given 5: Keyboard potentiometer limitation 6: Communication given 7: PULSE pulse setting (DI6)	0 (0~7)	Changeable at any time
F06.39 (0x0627)	Forward speed limit digital setting	Set the limit value of forward speed given by keyboard numbers	50.00Hz (0.00~F01.11)	Changeable at any time
F06.40 (0x0628)	Negative speed limit digital setting	Set the limit value of negative speed given by keyboard numbers	50.00Hz (0.00~F01.11)	Changeable at any time

7.10 Group F07: Current loop and flux control parameters

Parameter (address)	Name	Reference	Default (Setup range)	Adjustable properties
F07.00 (0x0700)	Current loop excitation axis proportional gain	Set the current loop excitation axis proportional gain	2000 (0~60000)	Changeable at any time
F07.01 (0x0701)	Current loop excitation axis integral gain	Set the current loop excitation axis integral gain	1000 (0~60000)	Changeable at any time

F07.02 (0x0702)	Current loop torque axis proportional gain	Set the current loop torque axis proportional gain	2000 (0~60000)	Changeable at any time
F07.03 (0x0703)	Current loop torque axis integral gain	Set the current loop torque axis integral gain	1000 (0~60000)	Changeable at any time
F07.04 (0x0704)	Current loop response coefficient	Set current loop response coefficient	0.50 (0.01~5.00)	Changeable at any time

7.11 Group F08: DI terminal function parameters

Parameter (address)	Name	Reference	Default (Setup range)	Adjustable properties
F08.00 (0x0800)	Terminal DI1 function selection	For details, refer to 7.30 Terminal input function selection.	1 (0~51)	Changeable only at stop
F08.01 (0x0801)	Terminal DI2 function selection		2 (0~51)	Changeable only at stop
F08.02 (0x0802)	Terminal DI3 function selection		0 (0~51)	Changeable only at stop
F08.03 (0x0803)	Terminal DI4 function selection		0 (0~51)	Changeable only at stop
F08.04 (0x0804)	Terminal DI5 function selection		0 (0~51)	Changeable only at stop
F08.05 (0x0805)	Terminal DI6 function selection		0 (0~51)	Changeable only at stop
F08.10 (0x080A)	Terminal control operation mode	0: Two-wire type 1 1: Two-wire type 2 2: Three-wire type 1 3: Three-wire type 2	0 (0~3)	Changeable only at stop
F08.11 (0x080B)	Terminal UP/DN change rate	Set the terminal UP/DN change rate	1.000Hz/s (0.001Hz/s~50.000Hz/s)	Changeable at any time
F08.12 (0x080C)	Terminal UP/DN control selection	0: Frequency power-off storage 1: Frequency is not stored when power is off.	0 (0~1)	Changeable only at stop
F08.13 (0x080D)	Terminal emergency stop deceleration time	Set terminal emergency stop deceleration time	1.0s (0.0s~6000.0s)	Changeable only at stop
F08.14 (0x080E)	DI1~DI5 are valid	Units digit: DI1 terminal characteristic setting Tens digit: DI2 terminal characteristic setting Hundreds digit: DI3 terminal characteristic setting Thousands digit: DI4 terminal characteristic setting Ten thousand digits: DI5 terminal special effects settings 0: closed and valid 1: Disconnect valid	00000 (00000~11111)	Changeable at any time
F08.15 (0x080F)	DI6 is valid	Units digit: DI6 terminal characteristic setting 0: closed and valid 1: Disconnect valid	0 (0~1)	Changeable at any time

F08.20 (0x0814)	High-speed pulse minimum input	Set the minimum input of high-speed pulse	0.00kHz (0.00kHz~F08.22)	Changeable at any time
F08.21 (0x0815)	High-speed pulse minimum input setting	Set the minimum input range of high-speed pulse	0.0% (-100.0%~100.0%)	Changeable at any time
F08.22 (0x0816)	High-speed pulse maximum input	Set the maximum high-speed pulse input	50.00kHz (F08.20~50.00kHz)	Changeable at any time
F08.23 (0x0817)	High-speed pulse maximum input setting	Set the maximum input range of high-speed pulse	100.0% (-100.0%~100.0%)	Changeable at any time
F08.24 (0x0818)	High speed pulse filter time	Set high-speed pulse filter time	0.10s (0.00s~10.00s)	Changeable at any time
F08.30 (0x081E)	DI1 filter time	Set DI1 filter time	0.010s (0.000s~1.000s)	Changeable at any time
F08.31 (0x081F)	DI2 filter time	Set DI2 filter time	0.010s (0.000s~1.000s)	Changeable at any time
F08.32 (0x0820)	DI3 filter time	Set DI3 filter time	0.010s (0.000s~1.000s)	Changeable at any time
F08.33 (0x0821)	DI4 filter time	Set DI4 filter time	0.010s (0.000s~1.000s)	Changeable at any time
F08.34 (0x0822)	DI5 filter time	Set DI5 filter time	0.010s (0.000s~1.000s)	Changeable at any time
F08.35 (0x0823)	DI6 filter time	Set DI6 filter time	0.010s (0.000s~1.000s)	Changeable at any time
F08.40 (0x0828)	DI1 delay time	Set DI1 delay time	0.0s (0.0~600.0s)	Changeable at any time
F08.41 (0x0829)	DI2 delay time	Set DI2 delay time	0.0s (0.0~600.0s)	Changeable at any time
F08.42 (0x082A)	DI3 delay time	Set DI3 delay time	0.0s (0.0~600.0s)	Changeable at any time
F08.43 (0x082B)	DI4 delay time	Set DI4 delay time	0.0s (0.0~600.0s)	Changeable at any time
F08.44 (0x082C)	DI5 delay time	Set DI5 delay time	0.0s (0.0~600.0s)	Changeable at any time
F08.45 (0x082D)	DI6 delay time	Set DI6 delay time	0.0s (0.0~600.0s)	Changeable at any time

7.12 Group F09: AI terminal function parameters

Parameter (address)	Name	Reference	Default (Setup range)	Adjustable properties
F09.00 (0x0900)	AI1 gain	Adjust the value of AI1 terminal input analog quantity	1.00 (-10.00~10.00)	Changeable at any time
F09.01 (0x0901)	AI1 offset	Set the AI1 input offset to adjust the zero point of the terminal output.	0.0% (-100.0%~100.0%)	Changeable at any time
F09.02 (0x0902)	AI1 filter time	Defines the size of the filter for the analog signal to eliminate interference signals.	0.10s (0.00s~10.00s)	Changeable at any time
F09.03 (0x0903)	AI2 gain	Adjust the AI2 terminal input analog value	1.00 (-10.00~10.00)	Changeable at any time
F09.04 (0x0904)	AI2 offset	Set the AI2 input offset to adjust the zero point of the terminal output.	0.0% (-100.0%~100.0%)	Changeable at any time

F09.05 (0x0905)	AI2 filter time	Defines the size of the filter for the analog signal to eliminate interference signals.	0.10s (0.00s~10.00s)	Changeable at any time
F09.06 (0x0906)	AI3 gain	Adjust the AI3 terminal input analog value	1.00 (-10.00~10.00)	Changeable at any time
F09.07 (0x0907)	AI3 offset	Set the AI3 input offset to adjust the zero point of the terminal output.	0.0% (-100.0%~100.0%)	Changeable at any time
F09.08 (0x0908)	AI3 filter time	Defines the size of the filter for the analog signal to eliminate interference signals.	0.10s (0.00s~10.00s)	Changeable at any time
F09.09 (0x0909)	Keyboard potentiometer gain	Adjust the keyboard potentiometer input analog value	1.00 (-10.00~10.00)	Changeable at any time
F09.10 (0x090A)	Keyboard Potentiometer Bias	Set the keyboard potentiometer offset to adjust the zero point of the terminal output.	0.0% (-100.0%~100.0%)	Changeable at any time
F09.11 (0x090B)	Keyboard potentiometer filter time	Defines the size of the filter for the analog signal to eliminate interference signals.	0.10s (0.00s~10.00s)	Changeable at any time
F09.12 (0x090C)	AI upper and lower limit cutoff values	Set the upper and lower limit cutoff values of the AI terminal	0.0% (0.0%~20.0%)	Changeable at any time
F09.13 (0x090D)	AI upper and lower limit truncation selection	Ones: AI1 Tens : AI2 Hundreds : AI3 Thousands:keyboard potentiometer 0: Not truncate 1: Truncation	0 (0000~1111)	Changeable at any time
F09.20 (0x0914)	AI curve type	Ones: AI1 Tens: AI2 Hundreds : AI3 Thousands:keyboard potentiometer 1: Curve 1 2: Curve 2 3: Curve 3 4: Curve 4 5: Curve 5	0X1321 (0X1111~0X3555)	Changeable at any time
F09.21 (0x0915)	AI curve 1 minimum input	Set the minimum signal input to AI curve 1. Voltage signals lower than this value will be processed as the minimum value.	0.00V (0.00~F09.23)	Changeable at any time
F09.22 (0x0916)	AI curve 1 minimum input corresponding setting	Corresponds to the set percentage value	0.0% (-100.0%~100.0%)	Changeable at any time
F09.23 (0x0917)	AI curve 1 maximum input	Set the maximum signal input to AI curve 1. Voltage signals higher than this value are processed as the maximum value.	10.00V (F09.21~10.00V)	Changeable at any time
F09.24 (0x0918)	AI curve 1 maximum input corresponding setting	corresponding to the set percentage value	100.0% (-100.0%~100.0%)	Changeable at any time
F09.25 (0x0919)	AI curve 2 minimum input	Set the minimum signal input to AI Curve 2. Voltage signals lower than this value will be processed as the minimum value.	0.00V (0.00V~F09.27)	Changeable at any time
F09.26 (0x091A)	AI curve 2 minimum input corresponding setting	Corresponds to the set percentage value	0.0% (-100.0%~100.0%)	Changeable at any time

F09.27 (0x091B)	AI curve 2 maximum input	Set the maximum signal input to AI curve 2. Voltage signals higher than this value are processed as the maximum value.	10.00V (F09.25~10.00V)	Changeable at any time
F09.28 (0x091C)	AI curve 2 maximum input corresponding setting	Corresponds to the set percentage value	100.0% (-100.0%~100.0%)	Changeable at any time
F09.29 (0x091D)	AI curve 3 minimum input	Set the minimum signal input to AI curve 3. Voltage signals lower than this value will be processed as the minimum value.	0.00V (0.00V~F09.31)	Changeable at any time
F09.30 (0x091E)	AI curve 3 minimum input corresponding setting	Corresponds to the set percentage value	0.0% (-100.0%~100.0%)	Changeable at any time
F09.31 (0x091F)	AI curve 3 maximum input	Set the maximum signal input to AI curve 3. Voltage signals higher than this value are processed as the maximum value.	10.00V (F09.29~10.00V)	Changeable at any time
F09.32 (0x0920)	AI curve 3 maximum input corresponding setting	corresponding to the set percentage value	100.0% (-100.0%~100.0%)	Changeable at any time
F09.33 (0x0921)	AI curve 4 minimum input	Set the minimum signal input to AI curve 4. Voltage signals lower than this value will be processed as the minimum value.	0.00V (0.00V~F09.35)	Changeable at any time
F09.34 (0x0922)	AI curve 4 minimum input corresponding setting	Corresponding to the set percentage value	0.0% (-100.0%~100.0%)	Changeable at any time
F09.35 (0x0923)	AI curve 4 inflection point 1 input	Set the signal input to the AI curve 4 inflection point 1	3.50V (F09.33~F09.37)	Changeable at any time
F09.36 (0x0924)	AI curve 4 inflection point 1 input corresponding setting	Corresponds to the set percentage value	35.0% (-100.0%~100.0%)	Changeable at any time
F09.37 (0x0925)	AI curve 4 inflection point 2 input	Set the signal input to AI curve 4 inflection point 2	7.00V (F09.35~F09.39)	Changeable at any time
F09.38 (0x0926)	AI curve 4 inflection point 2 input corresponding setting	Corresponds to the set percentage value	70.0% (-100.0%~100.0%)	Changeable at any time
F09.39 (0x0927)	AI curve 4 maximum input	Set the maximum signal input to AI curve 4. Voltage signals higher than this value are processed as the maximum value.	10.00V (F09.37~10.00V)	Changeable at any time
F09.40 (0x0928)	AI curve 4 maximum input corresponding setting	Corresponds to the set percentage value	100.0% (-100.0%~100.0%)	Changeable at any time
F09.41 (0x0929)	AI curve 5 minimum input	Set the minimum signal input to AI curve 5. Voltage signals lower than this value will be processed as the minimum value.	-10.00V (-10.00V~F09.43)	Changeable at any time
F09.42 (0x092A)	AI curve 5 minimum input corresponding setting	Corresponds to the set percentage value	-100.0% (-100.0%~100.0%)	Changeable at any time
F09.43 (0x092B)	AI curve 5 inflection point 1 input	Set the signal input to AI curve 5 inflection point 1	-3.00V (F09.41~F09.45)	Changeable at any time
F09.44 (0x092C)	AI curve 5 inflection point 1 input corresponding setting	Corresponds to the set percentage value	-30.0% (-100.0%~100.0%)	Changeable at any time
F09.45 (0x092D)	AI curve 5 inflection point 2 input	Set the signal input to AI curve 5 inflection point 2	3.00V (F09.43~F09.47)	Changeable at any time

F09.46 (0x092E)	AI curve 5 inflection point 2 input corresponding setting	corresponding to the set percentage value	30.0% (-100.0%~100.0%)	Changeable at any time
F09.47 (0x092F)	AI curve 5 maximum input	Set the maximum signal input to AI curve 5. Voltage signals higher than this value are processed as the maximum value.	10.00V (F09.45~10.00V)	Changeable at any time
F09.48 (0x0930)	AI curve 5 maximum input corresponding setting	Corresponds to the set percentage value	100.0% (-100.0%~100.0%)	Changeable at any time

7.13 Group F10: DO terminal function Parameters

Parameter (address)	Name	Reference	Default (Setup range)	Adjustable properties
F10.00 (0x0A00)	DO1 terminal function selection	For details, refer to 7.31 Terminal output function selection.	2 (0~35)	Changeable at any time
F10.01 (0x0A01)	DO2 terminal function selection		0 (0~35)	Changeable at any time
F10.02 (0x0A02)	RELAY relay function selection		8 (0~35)	Changeable at any time
F10.03 (0x0A03)	RELAY1 relay function selection		0 (0~35)	Changeable at any time
F10.05 (0x0A05)	DO2 output terminal select	0: Digital output 1: Pulse output (F11.02 select output function)	0 (0~1)	Changeable at any time
F10.06 (0x0A06)	Output terminal valid status selection	Ones: Control board DO1 Tens : Control board DO2 Hundreds : Relay of the control board Thousands: Control board Relay1 0: Positive logic 1: Reverse logic	0000 (0000~1111)	Changeable at any time
F10.10 (0x0A0A)	DO1 output delay time	Set DO1 output ON delay time.	0.0s (0.0s~3600.0s)	Changeable at any time
F10.11 (0x0A0B)	DO2 output delay time	Set DO2 output ON delay time.	0.0s (0.0s~3600.0s)	Changeable at any time
F10.12 (0x0A0C)	RELAY output delay time	Set the RELAY output ON delay time.	0.0s (0.0s~3600.0s)	Changeable at any time
F10.13 (0x0A0D)	RELAY1 output delay time	Set the RELAY1 output ON delay time.	0.0s (0.0s~3600.0s)	Changeable at any time
F10.20 (0x0A14)	Frequency detection value (FDT1)	Set frequency detection value 1	5.00Hz (0.00Hz~F01.11)	Changeable at any time
F10.21 (0x0A15)	Frequency detection hysteresis value (FDT1)	Set frequency detection amplitude 1	0.0% (0.0%~100.0%)	Changeable at any time
F10.22 (0x0A16)	Frequency detection value (FDT2)	Set frequency detection value 2	5.00Hz (0.00Hz~F01.11)	Changeable at any time
F10.23 (0x0A17)	Frequency detection hysteresis value (FDT2)	Set frequency detection amplitude 2	0.0% (0.0%~100.0%)	Changeable at any time
F10.24 (0x0A18)	Frequency reaches detection range	Set the frequency to reach the detection range	0.0% (0.0%~100.0%)	Changeable at any time
F10.25 (0x0A19)	Arbitrary arrival frequency detection value	Set any arrival frequency detection value	50.00Hz (0.00Hz~F01.11)	Changeable at any time
F10.26 (0x0A1A)	Arbitrary arrival frequency detection amplitude	Set any arrival frequency detection amplitude value	0.0% (0.0%~100.0%)	Changeable at any time

F10.29 (0x0A1D)	Zero current detection level	Set zero current detection threshold	5.0% (0.0%~300.0%)	Changeable at any time
F10.30 (0x0A1E)	Zero current detection delay time	Set zero current detection delay time	0.10s (0.01~60.00)	Changeable at any time
F10.31 (0x0A1F)	Output current exceeds limit value	Set the output current exceeding the limit value	200.0% (0.0%~300.0%)	Changeable at any time
F10.32 (0x0A20)	Output current over-limit detection delay time	Set detection delay time	0.01s (0.00~60.00)	Changeable at any time
F10.33 (0x0A21)	Arbitrary arrival current	Set any reaching current percentage	100.0% (0.0%~300.0%)	Changeable at any time
F10.34 (0x0A22)	Arbitrary current width	Set any reach current width range	0.0% (0.0%~300.0%)	Changeable at any time
F10.35 (0x0A23)	The module temperature reaches	Set the module temperature reaching value	90℃ (0℃~100℃)	Changeable at any time

7.14 Group F11: AO terminal function parameters

Parameter (address)	Name	Reference	Default (Setup range)	Adjustable properties
F11.00 (0x0B00)	AO1 output function selection	0: No function 1: Output frequency (0-maximum output frequency) 2: Given frequency (0-maximum output frequency)	1 (0~21)	Changeable at any time
F11.01 (0x0B01)	AO2 output function selection	3: Motor speed (0 - the maximum output frequency corresponding to the speed) 4: Output current (0-2 times the rated current of the inverter) 5: Output current (0-2 times motor rated current) 6: Output voltage (0-1.2 times the rated voltage of the inverter) 7: Given torque (0-2 times motor rated torque) 8: Output torque (0-2 times motor rated torque) 9: Output torque (0-2 times the rated torque of the inverter, with direction) 10: Output torque (0-1 times the rated torque of the inverter, with direction) 12: DC bus voltage (0-2.2 times the rated voltage of the inverter) 13: Output power (0-2 times motor rated power) 15: PULSE high-speed pulse input 17: Count value 18: Communication settings 19: PID given amount 20: PID feedback amount 21: AI1 input 22: AI2 input 23: AI3 input	2 (0~21)	Changeable at any time
F11.02 (0x0B02)	High-speed pulse output function selection		0 (0~23)	Changeable at any time
F11.05 (0x0B05)	High-speed pulse maximum output frequency	Set the upper limit value of high-speed pulse	50.00kHz (0.01kHz~50.00kHz)	Changeable at any time
F11.10 (0x0B0A)	AO1 gain	Adjust the value of the AO1 terminal output analog quantity	1.00 (-10.00~10.00)	Changeable at any time

F11.11 (0x0B0B)	AO1 zero offset	Set the AO1 output bias to adjust the zero point of the terminal output.	0.0% (-100.0%~ 100.0%)	Changeable at any time
F11.12 (0x0B0C)	AO2 gain	Adjust the value of the AO2 terminal output analog quantity	1.00 (-10.00~10.00)	Changeable at any time
F11.13 (0x0B0D)	AO2 zero offset	Set the AO2 output bias to adjust the zero point of the terminal output.	0.0% (-100.0%~ 100.0%)	Changeable at any time

7.15 Group F12: Auxiliary function parameters

Parameter (address)	Name	Reference	Default (Setup range)	Adjustable properties
F12.00 (0x0C00)	Wake frequency	Set wake frequency	0.00Hz (F12.02~F01.11)	Changeable at any time
F12.01 (0x0C01)	Wake-up delay time	Set wake-up delay time	0.0s (0.0s~6500.0s)	Changeable at any time
F12.02 (0x0C02)	Sleep frequency	Set sleep frequency	0.00Hz (0Hz~F12.00)	Changeable at any time
F12.03 (0x0C03)	Sleep delay time	Set the sleep delay time	0.0s (0s~6500.0s)	Changeable at any time
F12.07 (0x0C07)	Sag control	Control load balancing	0.00Hz (0.00~10.00Hz)	Changeable at any time
F12.08 (0x0C08)	Cooling fan control	0: Fan runs during operation 1: The fan keeps running 2: Automatically control fan operation according to temperature rise	0 (0~2)	Changeable at any time
F12.09 (0x0C09)	Output power correction coefficient	Set the output power correction ratio	100.0% (0.0%~200.0%)	Changeable only at stop
F12.10 (0x0COA)	Set count value	Set the maximum counter value	10000 (1~65535)	Changeable at any time
F12.11 (0x0C0B)	Specify count value	Set the current count value of the counter	10000 (1~65535)	Changeable at any time
F12.12 (0x0C0C)	Set length	Set the maximum length counter value	10000 (1~65535)	Changeable at any time
F12.13 (0x0C0D)	Actual length	Set the current value of the length counter	0 (1~65535)	Changeable at any time
F12.14 (0x0C0E)	pulses per meter	Set the number of pulses per meter of length	100.0 (0.1~6553.5)	Changeable at any time
F12.20 (0x0C14)	Swing frequency setting method	0: relative to center frequency 1: relative to maximum frequency	0 (0~1)	Changeable at any time
F12.21 (0x0C15)	Swing frequency amplitude	Set swing frequency amplitude	0.0% (0.0%~50.0%)	Changeable at any time
F12.22 (0x0C16)	Jump swing frequency amplitude	Set the sudden swing frequency amplitude	0.0% (0.0%~50.0%)	Changeable at any time
F12.23 (0x0C17)	Swing frequency period	Set the swing frequency period	10.0s (0.1s~6000.0s)	Changeable at any time
F12.24 (0x0C18)	Triangular wave rise time of swing frequency	Set the rise time of the triangular wave of the swing frequency	50.0% (0.1%~100.0%)	Changeable at any time
F12.30 (0x0C1E)	Scheduled running time	Set the time to run	0min (0min~6500.0min)	Changeable only at stop

F12.31 (0x0C1F)	Current running arrival time	Set the current running arrival time value	0 min (0min~6500.0min)	Changeable at any time
F12.32 (0x0C20)	Set cumulative running arrival time	Set cumulative running arrival time	0h (0h~65000h)	Changeable at any time
F12.33 (0x0C21)	Set the cumulative power-on arrival time	Set the cumulative power-on arrival time	0h (0h~65000h)	Changeable at any time
F12.34 (0x0C22)	Positioning run time unit	0:min 1:s	0 (0~1)	Changeable at any time

7.16 Group F13: Protection Parameters

Parameter (address)	Name	Reference	Default (Setup range)	Adjustable properties
F13.00 (0x0D00)	Overcurrent stall suppression	0: Disabled 1: Enabled	1 (0~1)	Changeable only at stop
F13.01 (0x0D01)	Overcurrent stall suppression action current	This parameter defines the percentage of overcurrent stall suppression action current threshold	150.0% (50%~200%)	Changeable only at stop
F13.02 (0x0D02)	Overcurrent stall suppression gain	This parameter defines the gain of overcurrent stall suppression response	50 (0~100)	Changeable at any time
F13.03 (0x0D03)	Compensation coefficient of speed multiplying overcurrent stall suppression action current	Reduce the high-speed overcurrent stall suppression action current threshold	50 (50~200)	Changeable only at stop
F13.04 (0x0D04)	Current protection Settings	Pulse-by-pulse current limit protection 0: Disabled 1: Enabled	1 (0~1)	Changeable only at stop
F13.07 (0x0D07)	Software overcurrent threshold	When the output current of the AC drive is higher than F13.07 (software overcurrent threshold) for a period longer than the time defined by F13.08 (output overcurrent detection delay), the DO terminal outputs an active signal	220.0% (0.0%~250%)	Changeable at any time
F13.08 (0x0D08)	Output overcurrent detection delay		0.01s (0.00~6.00s)	Changeable at any time
F13.10 (0x0D0A)	Overvoltage stall suppression	0: Disabled 1: Enabled	1 (0~1)	Changeable only at stop
F13.11 (0x0D0B)	Overvoltage stall suppression action voltage	This parameter defines the V/f overvoltage stall suppression action voltage threshold	220V model: 380.0V 380V model: 750.0V 440V model: 770.0V (200.0V to 820.0V)	Changeable only at stop
F13.12 (0x0D0C)	Overvoltage stall suppression frequency gain	Increase this value will improve the control effect of the bus voltage, but the output frequency will fluctuate	50 (0~100)	Changeable at any time
F13.13 (0x0D0D)	Overvoltage stall suppresses voltage gain	Suppress the bus voltage and increase this setting value can reduce the bus voltage overshoot	50 (0~100)	Changeable at any time
F13.14 (0x0D0E)	Frequency rise threshold for overvoltage stall suppression	Overvoltage stall suppression may increase the operating frequency. This parameter is the incremental upper limit of the operating frequency	5.00Hz (0~50.00Hz)	Changeable only at stop

F13.17 (0x0D11)	Start voltage for actuating braking unit	The start voltage for actuating braking unit, used to adjust the brake resistance energy consumption efficiency	220V model: 360.0V 380V model: 700.0V 440V model: 750.0V (200.0V to 820.0V)	Changeable at any time
F13.18 (0x0D12)	Braking unit usage	This parameter defines the usage rate of the braking unit	100.0% (0.0%~100.0%)	Changeable only at stop
F13.19 (0x0D13)	Overvoltage threshold	This parameter defines the bus overvoltage threshold	220V model: 400.0V 380V model: 820.0V 440V model: 820.0V (350.0V to 820.0V)	Changeable at any time
F13.20 (0x0D14)	Power dip ride-through	This parameter defines whether the AC driver runs during instantaneous power failure 0: Disabled 1: Keep bus voltage constant 2: Decelerate to stop	0 (0~2)	Changeable only at stop
F13.21 (0x0D15)	Voltage threshold for disabling power dip ride-through	This parameter defines the voltage threshold for disabling power dip ride-through of the AC driver, if voltage higher than this value, temporarily stop the adjustment	85.0% (80.0%~100.0%)	Changeable at any time
F13.22 (0x0D16)	Voltage threshold for enabling power dip ride-through	This parameter defines the voltage level at which the bus voltage is maintained upon power failure. Upon power failure, the bus voltage is maintained around F13.22 (voltage threshold for enabling power dip ride-through)	80.0% (60.0%~100.0%)	Changeable at any time
F13.23 (0x0D17)	Delay of voltage recovery from power dip	This parameter defines the time required for the bus voltage to rise from F13.21 (voltage threshold for disabling power dip ride-through) to the voltage before power failure	0.5s (0.0s~100.0s)	Changeable at any time
F13.24 (0x0D18)	Power dip ride-through gain Kp	This parameter is valid only in the "keep bus voltage constant" mode (F13.20 = 1).	50 (0~100)	Changeable at any time
F13.25 (0x0D19)	Power dip ride-through integral coefficient	If undervoltage occurs frequently during power dip ride-through, increase the power dip ride-through gain and integral coefficient	30 (0~100)	Changeable at any time
F13.26 (0x0D1A)	Deceleration time of power dip ride-through	This parameter is valid only in the "decelerate to stop" mode (F13.20 = 2). When the bus voltage is lower than the value of F13.22, the AC drive decelerates to stop. The deceleration time is determined by this parameter but not F	20.0s (0.0s~300.0s)	Changeable at any time
F13.29 (0x0D1D)	Undervoltage threshold	When the bus voltage falls below the setpoint of F13.29, the AC driver reports a fault	220V model: 200.0V 380V model: 350.0V 440V model: 350.0V (150.0V to 700.0V)	Changeable at any time
F13.33 (0x0D21)	Software short-to-ground detection	Ones: Short-to-ground detection upon power-on Tens: Short-to-ground detection before running 0: Disabled	11 (00~11)	Changeable only at stop

		1: Enabled		
F13.34 (0x0D22)	Input phase loss protection	0: Disabled 1: Enabled	1 (0~1)	Changeable at any time
F13.35 (0x0D23)	Input phase loss detection level	KC200 AC driver does not detect the input voltage, for three-phase 220V, 380V and 440V models, by detecting the fluctuation of the bus voltage to determine whether the input is out of phase, so the input will report out of phase fault only when adding a certain load.	10% (5~50%)	Changeable at any time
F13.36 (0x0D24)	Input phase loss detection time		10ms (5~2000ms)	Changeable at any time
F13.37 (0x0D25)	Output phase loss protection	Ones: Output phase loss protection Tens: Output phase loss protection before running 0: Disabled 1: Enabled	01 (00~11)	Changeable at any time
F13.38 (0x0D26)	Over temperature fault enable	0: enable 1: Prohibited	0 (0~1)	Changeable only at stop
F13.39 (0x0D27)	Narrow pulse width limit	0: enable 1: Prohibited	0 (0~1)	Changeable only at stop
F13.40 (0x0D28)	Frequency converter overload suppression enable	0: Prohibited 1: Allow	0 (0~1)	Changeable at any time
F13.41 (0x0D29)	Motor overload protection gain	Set motor overload protection gain	1.00 (0.20~10.00)	Changeable at any time
F13.42 (0x0D2A)	Motor overload pre-warning coefficient	The motor overload pre-warning coefficient is the percentage of time during which the motor runs at an overload threshold continuously without reporting an overload fault	80.0% (50.0%~100.0%)	Changeable at any time
F13.43 (0x0D2B)	Load loss protection	When the AC driver output current is lower than F13.44(load loss detection level), and the duration is greater than F13.45 (load loss detection time), the AC driver performs load drop protection action (load drop protection action can be selected by F13.43, default free stop). During the load loss protection period, if the load recovers, the AC driver will automatically resume to operate at the set frequency. 0: Disabled 1: Enabled	0 (0~1)	Changeable at any time
F13.44 (0x0D2C)	Load loss detection level	This parameter defines the load loss protection trigger threshold	10.0% (0.0%~100.0%)	Changeable at any time
F13.45 (0x0D2D)	Load loss detection time	This parameter defines the load loss protection trigger time	1.0s (0.0s~60.0s)	Changeable at any time

F13.50 (0x0D32)	Overspeed detection value	Set the over-speed protection trigger threshold	5.0% (0.0%~50.0%)	Changeable at any time
F13.51 (0x0D32)	Overspeed detection time	Set the over-speed protection triggering time	1.0s (0.0s~60.0s)	Changeable at any time
F13.52 (0x0D34)	Excessive speed deviation detection value	Set the detection threshold for excessive speed deviation	20.0% (0.0%~50.0%)	Changeable at any time
F13.53 (0x0D35)	Excessive speed deviation detection time	Set the trigger speed deviation excessive detection time length	5.0s (0.0s~60.0s)	Changeable at any time
F13.60 (0x0D3C)	Number of automatic fault resets	Set the number of automatic fault resets	0 (0~20)	Changeable at any time
F13.61 (0x0D3D)	DO action selection during automatic fault reset	0: No action 1: Action	0 (0~1)	Changeable at any time
F13.62 (0x0D3E)	Automatic fault reset interval	Set the length of time between two consecutive fault resets	1.0s (0.1s~100.0s)	Changeable at any time
F13.65 (0x0D41)	Fault protection action selection 1	Ones: Input phase loss Tens: Output phase loss Hundreds: Reserved Thousands: Reserved Ten thousands: Load loss 0: Coast to stop 1: Decelerate to stop 2: Continue to run	00000 (0~20022)	Changeable at any time
F13.66 (0x0D42)	Fault protection action selection 2	Ones: External fault Tens: Communication exception Hundreds:EEPROM communication exception Thousands: PID feedback loss Ten thousands: reserved 0: Coast to stop 1: Decelerate to stop 2: Continue to run	00000 (0~02222)	Changeable at any time
F13.67 (0x0D43)	Fault protection action selection 3	Ones: Accumulative running duration reach Tens: Accumulative power-on duration reach Hundreds: User-defined fault Thousands: Reserved Tens thousands: reserved 0: Coast to stop 1: Decelerate to stop 2: Continue to run	00000 (0~00222)	Changeable at any time

7.17 Group F14: Communication parameters

Parameter (address)	Name	Reference	Default (Setup range)	Adjustable properties
---------------------	------	-----------	-----------------------	-----------------------

F14.01 (0x0E01)	MODBUS baud rate	0: 1200 BPS 1: 2400 BPS 2: 4800 BPS 3: 9600 BPS 4: 19200 BPS 5: 38400 BPS 6: 57600 BPS 7: 115200 BPS	5 (0~7)	Changeable at any time
F14.02 (0x0E02)	MODBUS data format	0: (N, 8,1) No check, data bit: 8, stop bit: 1 1: (E, 8,1) Even parity, data bit: 8, stop bit: 1 2: (O, 8,1) Odd parity, data bit: 8, stop bit: 1 3: (N, 8,2) No check, data bit: 8, stop bit: 2 4: (E, 8,2) Even parity, data bit: 8, stop bit: 2 5: (O, 8,2) Odd parity, data bit: 8, stop bit: 2	0 (0~5)	Changeable at any time
F14.03 (0x0E03)	Local address	This parameter defines the local communication address	1 (0~247)	Changeable at any time
F14.04 (0x0E04)	Response delay	Interval between the end of the AC drive receiving data and sending data to the host computer	2ms (0ms~20ms)	Changeable at any time
F14.05 (0x0E05)	MODEBUS communication timeout	When set to 0.0s, the Modbus communication timeout is invalid. If not, it is valid. If the interval between this communication and the next communication exceeds F14.05 (MODBUS communication timeout), the system will report a communication fault	0.0s (0.0s~60.0s)	Changeable at any time
F14.06 (0x0E06)	Communication fault reset enable	0: Disabled 1: enable	1 (0~1)	Changeable only at stop
F14.07 (0x0E07)	Communication data transmission format	0: Standard MODBUS 1: non-standard	0 (0~1)	Changeable only at stop
F14.10 (0x0E0A)	Communication master-slave control	0: slave 1: Host	0 (0~1)	Changeable only at stop
F14.11 (0x0E0B)	Master-slave running command linkage	0: Master-slave running command linkage 1: Master-slave running commands are not linked	0 (0~1)	Changeable only at stop
F14.12 (0x0E0C)	Master-slave sending frequency command selection	0: given frequency 1: Set frequency (target frequency) 2: Maximum frequency	0 (0~2)	Changeable only at stop
F14.20 (0x0E14)	CAN communication baud rate	0: 20k bit/s 1: 50k bit/s 2: 100k bit/s 3: 125k bit/s 4: 250k bit/s 5: 500k bit/s 6: 800k bit/s 7: 1M bit/s	5 (0~7)	Changeable at any time

F14.21 (0x0E15)	CAN local address	Set the local address of CAN communication	1 (1~127)	Changeable at any time
F14.22 (0x0E16)	CAN communication timeout period	When the value is set to 0.0s, the CAN communication timeout is invalid. This parameter is valid when the value is not 0. If the interval between this communication and the next communication exceeds F14.22 (CAN communication timeout), the system will report a communication fault error.	0.0s (0.0s~60.0s)	Changeable at any time
F14.23 (0x0E17)	CAN heartbeat time	Set Canopen communication heartbeat time, corresponding to the object dictionary index 0x101700. The slave sends status packets periodically according to the heartbeat time. when the heartbeat time is 0, the Canopen supervision method is node protection.	1000ms (0~65535ms)	Changeable at any time
F14.24 (0x0E18)	CAN node protection time	Set the protection time of the Canopen communication node, corresponding to the object dictionary index 0x100c00. At the time of F14.23, the supervision method is node protection; the host sends node packets periodic, if the message is not received after more than F14.24*F14.25, the system will report a communication failure error.	1000ms (0~65535ms)	Changeable at any time
F14.25 (0x0E19)	CAN node protection factor	Set the protection time coefficient of the CANopen communication node, corresponding to object dictionary index 0x100D00. If F14.23 is 0, the monitoring mode is node protection. The host periodically sends node packets. If no packet is received within F14.24 * F14.25, the system reports a communication fault error.	3 (1~10)	Changeable only at stop
F14.30 (0x0E1E)	RPDO2 group mapping number	Set the number of mapping of the CanopenRPDO2 group, the corresponding object dictionary index 0x160100	2 (0~4)	Changeable at any time
F14.31 (0x0E1F)	RPDO2 mapping object 1	Set the mapping object 1 of the CanopenRPDO2 group, and the corresponding object dictionary index 0x160101	0x8103 (0x0000~0xffff)	Changeable at any time
F14.32 (0x0E20)	RPDO2 mapping object 2	Set the mapping object 2 of the CanopenRPDO2 group, and the corresponding object dictionary index 0x160102	0x8104 (0x0000~0xffff)	Changeable at any time
F14.33 (0x0E21)	RPDO2 mapping object 3	Set the mapping object 3 of the CanopenRPDO2 group, and the corresponding object dictionary index 0x160103	0x0000 (0x0000~0xffff)	Changeable at any time
F14.34 (0x0E22)	RPDO2 mapping object 4	Set the mapping object 4 of the CanopenRPDO2 group, and the corresponding object dictionary index 0x160104	0x0000 (0x0000~0xffff)	Changeable at any time

F14.35 (0x0E23)	RPDO3group mapping number	Set the number of mapping of the CanopenRPDO3 group, the corresponding object dictionary index 0x160200	0 (0~4)	Changeable at any time
F14.36 (0x0E24)	RPDO3 mapping object 1	Set the mapping object 1 of the CanopenRPDO3 group, and the corresponding object dictionary index 0x160201	0x0000 (0x0000~0xffff)	Changeable at any time
F14.37 (0x0E25)	RPDO3 mapping object 2	Set the mapping object 2 of the CanopenRPDO3 group, and the corresponding object dictionary index 0x160202	0x0000 (0x0000~0xffff)	Changeable at any time
F14.38 (0x0E26)	RPDO3 mapping object 3	Set the mapping object 3 of the CanopenRPDO3 group, and the corresponding object dictionary index 0x160203	0x0000 (0x0000~0xffff)	Changeable at any time
F14.39 (0x0E27)	RPDO3 mapping object 4	Set the mapping object 4 of the CanopenRPDO3 group, and the corresponding object dictionary index 0x160204	0x0000 (0x0000~0xffff)	Changeable at any time
F14.40 (0x0E28)	TPDO1 transport type	Set the transport type of TPDO1, corresponding to object dictionary index 0x180002. 1-240 indicates the synchronous transmission type. After receiving the corresponding number of synchronization packets, the packets are sent once. 254,255 indicates the asynchronous transmission type	255 (1~255)	Changeable at any time
F14.41 (0x0E29)	TPDO1 disable time	Set TPDO1 forbidden time, corresponding to the object dictionary index 0x180003. When the transmission type is asynchronous transmission, the content of the data in the group changes in the content of the object data in the group, and the data is returned once every time the interval is prohibited.	300ms (0~65535ms)	Changeable at any time
F14.42 (0x0E2A)	TPDO1 event time	Set the TPDO1 event time, corresponding to the object dictionary index 0x180005. When the transmission type is transmitted asynchronous, the mapping object is reported regularly for each interval event.	1000ms (0~65535ms)	Changeable at any time
F14.43 (0x0E2B)	TPDO2 transport type	Set the transport type of TPDO2, which corresponds to object dictionary index 0x180102. 1-240 indicates the synchronous transmission type. After receiving the corresponding number of synchronization packets, the packets are sent once. 254,255 indicates the asynchronous transmission type	255 (1~255)	Changeable at any time
F14.44 (0x0E2C)	TPDO2 disable time	Set TPDO2 forbidden time, corresponding to the object dictionary index 0x180103. When the transmission type is asynchronous transmission, the content of the data in the group changes in the content of the object data in the group, and the data is returned once every time the interval is	300ms (0~65535ms)	Changeable at any time

		prohibited.		
F14.45 (0x0E2D)	TPDO2 event time	Set the TPDO2 event time, corresponding to the object dictionary index 0x180105. When the transmission type is transmitted asynchronous, the mapping object is reported regularly for each interval event.	1000ms (0~65535ms)	Changeable at any time
F14.46 (0x0E2E)	TPDO3 transport type	Set the transport type of TPDO3, which corresponds to object dictionary index 0x180202. 1-240 indicates the synchronous transmission type. After receiving the corresponding number of synchronization packets, the packets are sent once. 254,255 indicates the asynchronous transmission type	255 (1~255)	Changeable at any time
F14.47 (0x0E2F)	TPDO3 disable time	Set TPDO3 prohibition time, corresponding to the object dictionary index 0x180203. When the transmission type is asynchronous transmission, the content of the data in the group changes in the content of the object data in the group, and the data is returned once every time the interval is prohibited.	300ms (0~65535ms)	Changeable at any time
F14.48 (0x0E30)	TPDO3 event time	Set the TPDO3 event time, corresponding to the object dictionary index 0x180205. When the transmission type is transmitted asynchronous, the mapping object is reported regularly for each interval event.	1000ms (0~65535ms)	Changeable at any time
F14.49 (0x0E31)	TPDO2 group mapping number	Set the number of mappings to the CANopen TPDO2 group, corresponding to object dictionary index 0x1A0100	3 (0~4)	Changeable at any time
F14.50 (0x0E32)	TPDO2 mapping object 1	Set mapping object 1 of group CANopenTPDO2.The corresponding object dictionary index 0x1A0101 is specified	0x6000 (0x0000~0xffff)	Changeable at any time
F14.51 (0x0E33)	TPDO2 mapping object 2	Set mapping object 2 of group CANopenTPDO2.The corresponding object dictionary index 0x1A0102 is specified	0x6007 (0x0000~0xffff)	Changeable at any time
F14.52 (0x0E34)	TPDO2 mapping object 3	Set mapping object 3 of group CANopenTPDO2.The corresponding object dictionary index 0x1A0103 is specified	0x6013 (0x0000~0xffff)	Changeable at any time
F14.53 (0x0E35)	TPDO2 mapping object 4	Set mapping object 4 of group CANopenTPDO2.The corresponding object dictionary index 0x1A0104 is specified	0x0000 (0x0000~0xffff)	Changeable at any time
F14.54 (0x0E36)	TPDO3group mapping number	Set the number of mappings to the CANopen TPDO3 group, corresponding to object dictionary index 0x1A0200	0 (0~4)	Changeable at any time

F14.55 (0x0E37)	TPDO3 mapping object 1	Set mapping object 1 of group CANopenTPDO3.The corresponding object dictionary index 0x1A0201 is specified	0x0000 (0x0000~0xffff)	Changeable at any time
F14.56 (0x0E38)	TPDO3 mapping object 2	Set mapping object 2 of group CANopenTPDO3.The corresponding object dictionary index 0x1A0202 is specified	0x0000 (0x0000~0xffff)	Changeable at any time
F14.57 (0x0E39)	TPDO3 mapping object 3	Set mapping object 3 of group CANopenTPDO3.The corresponding object dictionary index 0x1A0203 is specified	0x0000 (0x0000~0xffff)	Changeable at any time
F14.58 (0x0E3A)	TPDO3mapping object 4	Set mapping object 4 of group CANopenTPDO3.The corresponding object dictionary index 0x1A0204 is specified	0x0000 (0x0000~0xffff)	Changeable at any time

7.18 Group F15: Display parameters

Parameter (address)	Name	Reference	Default (Setup range)	Adjustable properties
F15.00 (0x0F00)	M key function	0: M key disabled 1: Switchover between operating panel control and remote control (terminal I/O control or communication control) 2 : Switchover between forward and reverse run 3: Forward jogging 4: Reverse jogging	0 (0~4)	Changeable only at stop
F15.01 (0x0F01)	STOP/RESET key function	0: The STOP/RESET key is valid only in operating panel control mode 1:The STOP/RESET key is valid in any operation mode	0 (0~1)	Changeable only at stop
F15.02 (0x0F02)	Load speed display coefficient	This parameter defines load speed display coefficient	1.0000 (0.0001~6.0000)	Changeable at any time
F15.10 (0x0F0A)	LED display 1 in running state	0: Disabled 1: Main frequency X 2: Auxiliary frequency Y	5 (0~63)	Changeable at any time
F15.11 (0x0F0B)	LED display 2 in running state	3: Setting frequency (after acceleration and deceleration)	3 (0~63)	Changeable at any time
F15.12 (0x0F0C)	LED display 3 in running state	4: Reference frequency (target value) 5: Running frequency	7 (0~63)	Changeable at any time
F15.13 (0x0F0D)	LED display 4 in running state	6: Output voltage 7: Output current	6 (0~63)	Changeable at any time
F15.14 (0x0F0E)	LED display 5 in running state	8: DC-Bus voltage 9: Setting torque 10: Output torque	8 (0~63)	Changeable at any time
F15.15 (0x0F0F)	LED display 1 in stop state	11: Output power 12: Setting speed 13: Running speed	4 (0~63)	Changeable at any time
F15.16 (0x0F10)	LED display 2 in stop state	14: AC drive operating status 15: AC drive temperature 16: Motor temperature	8 (0~63)	Changeable at any time
F15.17 (0x0F11)	LED display 3 in stop state	17: DI state 18: DO state	20 (0~63)	Changeable at any time
F15.18 (0x0F12)	LED display 4 in stop state	19: AI voltage before correction 20: AI voltage 25: Operating panel potentiometer voltage before correction	26 (0~63)	Changeable at any time
F15.19	LED display 5 in		0	Changeable

(0x0F13)	stop state	26: Operating panel potentiometer voltage 27: AO output 29: Input PULSE frequency (0.01KHz) 30: Output PULSE frequency (0.01KHz) 31: V/f separation target voltage 32: V/f separation output voltage 33: Communication setpoint 34: PID reference 35: PID feedback 36: PID error 37: PID integral value 38: PID output 40: Count value 45: Power factor angle 46: Motor speed feedback 48: Load speed 57: Remaining running time 58: Current power-on duration 59: Current running duration 60: High-order bits of accumulative power consumption 61: Low-order bits of accumulative power consumption 62: High-order bits of current power consumption 63: Low-order bits of current power consumption	(0~63)	at any time
----------	------------	---	--------	-------------

7.19 Group F16: PID parameters

Parameter (address)	Name	Reference	Default (Setup range)	Adjustable properties
F16.00 (0x1000)	PID given signal source	0: Keyboard digital PID given (F16.01) 1: AI1 2: AI2 3: AI3 4: Keyboard potentiometer given 5: Communication given 6: PULSE setting (DI6)	0 (0~6)	Changeable at any time
F16.01 (0x1001)	Keyboard number PID given	Set keyboard digital PID given value	50.0% (0.0%~100.0%)	Changeable at any time
F16.02 (0x1002)	PID given change time	Set PID given change time	0.00s (0.00s~100.00s)	Changeable at any time
F16.03 (0x1003)	PID controller feedback signal source	0: AI1 1: AI2 2: AI3 3: Keyboard potentiometer given 4: Communication given 5: PULSE setting (DI6)	0 (0~5)	Changeable at any time
F16.04 (0x1004)	PID feedback filter time	Set PID feedback signal filter time	0.00s (0.00s~60.00s)	Changeable at any time
F16.06 (0x1006)	PID initial value	Set PID initial value	0.0% (0.0%~100.0%)	Changeable at any time

F16.07 (0x1007)	PID initial value holding time	Set PID initial value retention time	0.00s (0.00s~650.00s)	Changeable at any time
F16.09 (0x1009)	Proportional gain Kp1	Set proportional gain KP1	20.0 (0.0~1000.0s)	Changeable at any time
F16.10 (0x100A)	Integration time Ti1	Set the integration time Ti1	2.00s (0.01s~100.00s)	Changeable at any time
F16.11 (0x100B)	Differential time Td1	Set the differential time Td1	0.000s (0.00s~10.000s)	Changeable at any time
F16.12 (0x100C)	Proportional gain Kp2	Set proportional gain KP2	20.0 (0.0~1000.0)	Changeable at any time
F16.13 (0x100D)	Integration time Ti2	Set the integration time Ti2	2.00s (0.01s~100.00s)	Changeable at any time
F16.14 (0x100E)	Differential time Td2	Set the differential time Td2	0.000s (0.00s~10.000s)	Changeable at any time
F16.15 (0x100F)	PID differential limiting	Set PID differential limiter	0.10% (0.0%~100.0%)	Changeable at any time
F16.16 (0x1010)	PID adjustment characteristics	0: Positive characteristics 1: Negative characteristics	0 (0~1)	Changeable at any time
F16.17 (0x1011)	PID deviation limit	Set PID deviation limit	0.0% (0.0%~100.0%)	Changeable at any time
F16.20 (0x1014)	PID operation mode	0: Stop and no operation 1: Stop operation	0 (0~1)	Changeable at any time
F16.22 (0x1016)	PID inversion cutoff frequency	Set PID inversion cutoff frequency	1.00Hz (0.00Hz~F01.11)	Changeable at any time
F16.23 (0x1017)	PID parameter switching conditions	0: No switching 1: DI terminal 2: Automatically switch according to deviation 3: Switch according to operating frequency	0 (0~3)	Changeable at any time
F16.24 (0x1018)	PID parameter switching deviation 1	Set the switching deviation value 1. When the PID deviation is less than this value, use the gain 1 parameter.	20.0% (0.0%~F16.25)	Changeable at any time
F16.25 (0x1019)	PID parameter switching deviation 2	Set the switching deviation value 2. When the PID deviation is greater than this value, use the gain 2 parameter.	80.0% (F16.24~100.0%)	Changeable at any time
F16.26 (0x101A)	PID output filter time	Set PID output filter time	10ms (0~1000ms)	Changeable at any time
F16.27 (0x101B)	PID feedback upper limit exceeds limit value	Set the PID feedback upper limit exceeding the limit value	0.0% (0.0%~100.0%)	Changeable at any time
F16.28 (0x101C)	PID feedback lower limit exceeds limit value	Set the PID feedback lower limit exceedance value	0.0% (0.0%~100.0%)	Changeable at any time
F16.30 (0x101E)	PID feedback loss detection time	Set PID feedback loss detection time	0.0s (0.0s~20.0s)	Changeable at any time

7.20 Group F17: Multi-reference parameters

Parameter (address)	Name	Reference	Default (Setup range)	Adjustable properties
F17.00 (0x1100)	Multi-step speed command 0 given mode	0: Keyboard digital given frequency (F01.10) 1: AI1 given 2: AI2 given	0 (0~7)	Changeable at any time

		3: AI3 given 4: Keyboard potentiometer given 5: Communication given 6: PULSE pulse given (DI6) 7: PID given		
F17.01 (0x1101)	Multi-speed command 1	Set multi-speed frequency command 1	5.00Hz (0.00Hz~F01.11)	Changeable at any time
F17.02 (0x1102)	Multi-speed command 2	Set multi-speed frequency command 2	5.00Hz (0.00Hz~F01.11)	Changeable at any time
F17.03 (0x1103)	Multi-speed command 3	Set multi-speed frequency command 3	5.00Hz (0.00Hz~F01.11)	Changeable at any time
F17.04 (0x1104)	Multi-speed command 4	Set multi-speed frequency command 4	5.00Hz (0.00Hz~F01.11)	Changeable at any time
F17.05 (0x1105)	Multi-speed command 5	Set multi-speed frequency command 5	5.00Hz (0.00Hz~F01.11)	Changeable at any time
F17.06 (0x1106)	Multi-speed command 6	Set multi-speed frequency command 6	5.00Hz (0.00Hz~F01.11)	Changeable at any time
F17.07 (0x1107)	Multi-speed command 7	Set multi-speed frequency command 7	5.00Hz (0.00Hz~F01.11)	Changeable at any time
F17.08 (0x1108)	Multi-speed command 8	Set multi-speed frequency command 8	5.00Hz (0.00Hz~F01.11)	Changeable at any time
F17.09 (0x1109)	Multi-speed command 9	Set multi-speed frequency command 9	5.00Hz (0.00Hz~F01.11)	Changeable at any time
F17.10 (0x110A)	Multi-speed command 10	Set multi-speed frequency command 10	5.00Hz (0.00Hz~F01.11)	Changeable at any time
F17.11 (0x110B)	Multi-speed command 11	Set multi-speed frequency command 11	5.00Hz (0.00Hz~F01.11)	Changeable at any time
F17.12 (0x110C)	Multi-speed command 12	Set multi-speed frequency command 12	5.00Hz (0.00Hz~F01.11)	Changeable at any time
F17.13 (0x110D)	Multi-speed command 13	Set multi-speed frequency command 13	5.00Hz (0.00Hz~F01.11)	Changeable at any time
F17.14 (0x110E)	Multi-speed command 14	Set multi-speed frequency command 14	5.00Hz (0.00Hz~F01.11)	Changeable at any time
F17.15 (0x110F)	Multi-speed command 15	Set multi-speed frequency command 15	5.00Hz (0.00Hz~F01.11)	Changeable at any time
F17.17 (0x1111)	Simple PLC operation mode	Ones: circular mode 0: Stop after single cycle 1: Keep the final value after a single cycle 2: Continuous loop Tens : timing unit 0: seconds (s) 1: Minutes (min) 2: hours (h) Hundreds digit: power-off storage method 0: Do not store 1: Storage Thousands digit: shutdown memory mode 0: No memory when shutdown 1: Stop memory	0x0000 (0x0000~0x1122)	Changeable at any time
F17.19 (0x1113)	PLC segment 0 running time	Set the running time of PLC segment 0	0.0s(min/h) (0.0~6500.0s(min/h))	Changeable at any time
F17.20 (0x1114)	PLC phase 0 setup	Ones: running direction of this segment (also applicable to multi-speed commands)	0x00 (0x00~0x31)	Changeable at any time

		0: Same direction 1: Reverse Tens: acceleration and deceleration time of this section 0: Acceleration and deceleration time 1 (F01.23, F01.24) 1: Acceleration and deceleration time 2 (F01.25, F01.26) 2: Acceleration and deceleration time 3 (F01.27, F01.28) 3: Acceleration and deceleration time 4 (F01.29, F01.30)		
F17.21 (0x1115)	PLC first stage running time	Same as F17.19	0.0s(min/h) (0.0~ 6500.0s(min/h))	Changeable at any time
F17.22 (0x1116)	PLC phase 1 setup	Same as F17.20	0x00 (0x00~0x31)	Changeable at any time
F17.23 (0x1117)	PLC second stage running time	Same as F17.19	0.0s(min/h) (0.0~ 6500.0s(min/h))	Changeable at any time
F17.24 (0x1118)	PLC stage 2 setup	Same as F17.20	0x00 (0x00~0x31)	Changeable at any time
F17.25 (0x1119)	PLC section 3 running time	Same as F17.19	0.0s(min/h) (0.0~ 6500.0s(min/h))	Changeable at any time
F17.26 (0x111A)	PLC stage 3 setup	Same as F17.20	0x00 (0x00~0x31)	Changeable at any time
F17.27 (0x111B)	PLC section 4 running time	Same as F17.19	0.0s(min/h) (0.0~ 6500.0s(min/h))	Changeable at any time
F17.28 (0x111C)	PLC stage 4 setup	Same as F17.20	0x00 (0x00~0x31)	Changeable at any time
F17.29 (0x111D)	PLC section 5 running time	Same as F17.19	0.0s(min/h) (0.0~ 6500.0s(min/h))	Changeable at any time
F17.30 (0x111E)	PLC stage 5 setup	Same as F17.20	0x00 (0x00~0x31)	Changeable at any time
F17.31 (0x111F)	PLC section 6 running time	Same as F17.19	0.0s(min/h) (0.0~ 6500.0s(min/h))	Changeable at any time
F17.32 (0x1120)	PLC stage 6 setup	Same as F17.20	0x00 (0x00~0x31)	Changeable at any time
F17.33 (0x1121)	PLC segment 7 running time	Same as f/17.19	0.0s(min/h) (0.0~ 6500.0s(min/h))	Changeable at any time
F17.34 (0x1122)	PLC stage 7 setup	Same as F17.20	0x00 (0x00~0x31)	Changeable at any time
F17.35 (0x1123)	PLC segment 8 running time	Same as F17.19	0.0s(min/h) (0.0~ 6500.0s(min/h))	Changeable at any time
F17.36 (0x1124)	PLC stage 8 setup	Same as F17.20	0x00 (0x00~0x31)	Changeable at any time
F17.37 (0x1125)	PLC section 9 running time	Same as F17.19	0.0s(min/h) (0.0~ 6500.0s(min/h))	Changeable at any time
F17.38 (0x1126)	PLC stage 9 setup	Same as F17.20	0x00 (0x00~0x31)	Changeable at any time

F17.39 (0x1127)	PLC 10th segment running time	Same as F17.19	0.0s(min/h) (0.0~ 6500.0s(min/h))	Changeable at any time
F17.40 (0x1128)	PLC stage 10 setup	Same as F17.20	0x00 (0x00~0x31)	Changeable at any time
F17.41 (0x1129)	PLC segment 11 running time	Same as F17.19	0.0s(min/h) (0.0~ 6500.0s(min/h))	Changeable at any time
F17.42 (0x112A)	PLC stage 11 setup	Same as F17.20	0x00 (0x00~0x31)	Changeable at any time
F17.43 (0x112B)	PLC segment 12 running time	Same as F17.19	0.0s(min/h) (0.0~ 6500.0s(min/h))	Changeable at any time
F17.44 (0x112C)	PLC stage 12 setup	Same as F17.20	0x00 (0x00~0x31)	Changeable at any time
F17.45 (0x112D)	PLC segment 13 running time	Same as F17.19	0.0s(min/h) (0.0~ 6500.0s(min/h))	Changeable at any time
F17.46 (0x112E)	PLC stage 13 setup	Same as F17.20	0x00 (0x00~0x31)	Changeable at any time
F17.47 (0x112F)	PLC segment 14 running time	Same as F17.19	0.0s(min/h) (0.0~ 6500.0s(min/h))	Changeable at any time
F17.48 (0x1130)	PLC stage 14 setup	Same as F17.20	0x00 (0x00~0x31)	Changeable at any time
F17.49 (0x1131)	PLC segment 15 running time	Same as F17.19	0.0s(min/h) (0.0~ 6500.0s(min/h))	Changeable at any time
F17.50 (0x1132)	PLC stage 15 setup	Same as F17.20	0x00 (0x00~0x31)	Changeable at any time

7.21 Group F18: Extended terminal parameters

Parameter (address)	Name	Reference	Default (Setup range)	Adjustable properties
F18.00 (0x1200)	AI1 when DI function selection	For details, refer to 7.30 Terminal input function selection Note: When AI1 is greater than 7V, it is valid, and when it is less than 3V, it is invalid.	0 (0~51)	Changeable only at stop
F18.01 (0x1201)	AI2 when DI function selection	For details, refer to 7.30 Terminal input function selection Note: When AI2 is greater than 7V, it is valid, and when it is less than 3V, it is invalid.	1 (0~51)	Changeable only at stop
F18.02 (0x1202)	AI3 as DI function selection	For details, refer to 7.30 Terminal input function selection Note: When AI3 is greater than 7V, it is valid, and when it is less than 3V, it is invalid.	2 (0~51)	Changeable only at stop

<p>F18.03 (0x1203)</p>	<p>AI when DI terminal characteristics</p>	<p>Ones: AI1 as DI terminal characteristics Tens: AI2 as DI terminal characteristics Hundreds : AI3 as DI terminal characteristics 0: Closed and valid 1: Disconnect valid</p>	<p>000 (000~111)</p>	<p>Changeable at any time</p>
----------------------------	--	--	--------------------------	-------------------------------

7.22 Group F19 : Communication mapping parameters

Parameter (address)	Name	Reference	Default (Setup range)	Adjustable properties
<p>F19.00 (0x1300)</p>	<p>Communication address mapping is enabled</p>	<p>0: Disable 1: Ebable</p>	<p>0 (0~1)</p>	<p>Changeable only at stop</p>
<p>F19.01 (0x1301)</p>	<p>Communication address mapping preimage 1</p>	<p>F19.01-F19.15 sets the preimage parameters of 1-15 groups communication address mapping, which correspond to F19.16-F19.30 one by one (F19.01 corresponds to F19.16). Taking the first group as an example, the user writes any address within the set range to F19.16 according to the demand, and then writes the address of the corresponding function within the KC200 inverter function code range to F19.01, user can realize the function of communicating and operating the corresponding function code of the KC200 inverter through the required specific address.</p>	<p>0x0000 (0x0000~0xffff)</p>	<p>Changeable at any time</p>
<p>F19.02 (0x1302)</p>	<p>Communication address mapping preimage 2</p>		<p>0x0000 (0x0000~0xffff)</p>	<p>Changeable at any time</p>
<p>F19.03 (0x1303)</p>	<p>Communication address mapping preimage 3</p>		<p>0x0000 (0x0000~0xffff)</p>	<p>Changeable at any time</p>
<p>F19.04 (0x1304)</p>	<p>Communication address mapping preimage 4</p>		<p>0x0000 (0x0000~0xffff)</p>	<p>Changeable at any time</p>
<p>F19.05 (0x1305)</p>	<p>Communication address mapping preimage 5</p>		<p>0x0000 (0x0000~0xffff)</p>	<p>Changeable at any time</p>
<p>F19.06 (0x1306)</p>	<p>Communication address mapping preimage 6</p>		<p>0x0000 (0x0000~0xffff)</p>	<p>Changeable at any time</p>
<p>F19.07 (0x1307)</p>	<p>Communication address mapping preimage 7</p>		<p>0x0000 (0x0000~0xffff)</p>	<p>Changeable at any time</p>
<p>F19.08 (0x1308)</p>	<p>Communication address mapping preimage 8</p>		<p>0x0000 (0x0000~0xffff)</p>	<p>Changeable at any time</p>
<p>F19.09 (0x1309)</p>	<p>Communication address mapping preimage 9</p>		<p>0x0000 (0x0000~0xffff)</p>	<p>Changeable at any time</p>
<p>F19.10 (0x130A)</p>	<p>Communication address mapping preimage 10</p>		<p>0x0000 (0x0000~0xffff)</p>	<p>Changeable at any time</p>
<p>F19.11 (0x130B)</p>	<p>Communication address mapping preimage 11</p>		<p>0x0000 (0x0000~0xffff)</p>	<p>Changeable at any time</p>
<p>F19.12 (0x130C)</p>	<p>Communication address mapping preimage 12</p>		<p>0x0000 (0x0000~0xffff)</p>	<p>Changeable at any time</p>
<p>F19.13 (0x130D)</p>	<p>Communication address mapping preimage 13</p>		<p>0x0000 (0x0000~0xffff)</p>	<p>Changeable at any time</p>
<p>F19.14 (0x130E)</p>	<p>Communication address mapping preimage 14</p>		<p>0x0000 (0x0000~0xffff)</p>	<p>Changeable at any time</p>
<p>F19.15 (0x130F)</p>	<p>Communication address mapping</p>		<p>0x0000 (0x0000~0xffff)</p>	<p>Changeable at any time</p>

	preimage 15			
F19.16 (0x1310)	Communication address mapping image 1	F19.16-F19.30 sets 1-15 groups of communication address mapping parameters, which correspond to F19.01-F19.15 one by one (F19.01 corresponds to F19.16). Taking the first group as an example, the user writes any address within the set range to F19.16 according to the demand, and then writes the address of the corresponding function within the KC200 inverter function code range to F19.01, user can realize the function of communicating and operating the corresponding function code of the KC200 inverter through the required specific address.	0x0000 (0x0000~0xffff)	Changeable at any time
F19.17 (0x1311)	Communication address mapping image 2		0x0000 (0x0000~0xffff)	Changeable at any time
F19.18 (0x1312)	Communication address mapping image 3		0x0000 (0x0000~0xffff)	Changeable at any time
F19.19 (0x1313)	Communication address mapping image 4		0x0000 (0x0000~0xffff)	Changeable at any time
F19.20 (0x1314)	Communication address mapping image 5		0x0000 (0x0000~0xffff)	Changeable at any time
F19.21 (0x1315)	Communication address mapping image 6		0x0000 (0x0000~0xffff)	Changeable at any time
F19.22 (0x1316)	Communication address mapping image 7		0x0000 (0x0000~0xffff)	Changeable at any time
F19.23 (0x1319)	Communication address mapping image 8		0x0000 (0x0000~0xffff)	Changeable at any time
F19.24 (0x1318)	Communication address mapping image 9		0x0000 (0x0000~0xffff)	Changeable at any time
F19.25 (0x1319)	Communication address mapping image 10		0x0000 (0x0000~0xffff)	Changeable at any time
F19.26 (0x131A)	Communication address mapping image 11		0x0000 (0x0000~0xffff)	Changeable at any time
F19.27 (0x131B)	Communication address mapping image 12		0x0000 (0x0000~0xffff)	Changeable at any time
F19.28 (0x131C)	Communication address mapping image 13		0x0000 (0x0000~0xffff)	Changeable at any time
F19.29 (0x131D)	Communication address mapping image 14		0x0000 (0x0000~0xffff)	Changeable at any time
F19.30 (0x131E)	Communication address mapping image 15		0x0000 (0x0000~0xffff)	Changeable at any time

7.23 Group A00: Advanced performance parameters

Parameter (address)	Name	Reference	Default (Setup range)	Adjustable properties
A00.02 (0x2302)	Motor 2 control mode	0: V/F control 1: Speed sensorless vector control (SVC) 2: Speed sensor vector control (FVC)	0 (0~2)	Changeable only at stop

7.24 Group A03: Motor 2 parameters

Parameter (address)	Name	Reference	Default (Setup range)	Adjustable properties
A03.00 (0x2300)	Motor type selection	0: Asynchronous motor 1: Synchronous motor	0 (0~1)	Changeable only at stop
A03.02 (0x2302)	Motor rated power	Set the rated power of the motor	Model settings (0.1kW~1000.0kW)	Changeable only at stop
A03.03 (0x2303)	Motor rated voltage	Set the rated voltage of the motor	Model settings (1V~500V)	Changeable only at stop
A03.04 (0x2304)	Motor rated current	Set the rated current of the motor	Model settings (0.01A~6000.0A)	Changeable only at stop
A03.05 (0x2305)	Motor rated frequency	Set the rated frequency of the motor	Model settings (0.01Hz~F01.11)	Changeable only at stop
A03.06 (0x2306)	Motor rated speed	Set the rated speed of the motor	Model settings (1~65535rpm)	Changeable only at stop
A03.09 (0x2309)	Motor parameter self-learning	0: No operation 1: Static self-learning (some parameters) 2: Rotation self-learning (all parameters)	0 (0~2)	Changeable only at stop
A03.10 (0x230A)	Asynchronous motor stator resistance	Set the DC resistance of the asynchronous motor stator winding	Model settings (0.0001~65.535 Ω)	Changeable only at stop
A03.11 (0x230B)	Asynchronous motor rotor resistance	Set the DC resistance of the asynchronous motor rotor winding	Model settings (0.0001~65.535 Ω)	Changeable only at stop
A03.12 (0x230C)	Asynchronous motor leakage inductance	Set the leakage inductance of asynchronous motor	Model settings (0.001~655.35mH)	Changeable only at stop
A03.13 (0x230D)	Asynchronous motor mutual inductance	Set the mutual inductance of asynchronous motor	Model settings (0.01~6553.5mH)	Changeable only at stop
A03.14 (0x230E)	Asynchronous motor no-load current	Set the current flowing through the stator three-phase winding when the asynchronous motor is running without load	Model settings (0.01A~A03.04)	Changeable only at stop
A03.20 (0x2314)	Synchronous motor stator resistance	This parameter defines the DC resistance of the synchronous motor stator winding	Model settings (0.0001~65.535 Ω)	Changeable only at stop
A03.21 (0x2315)	Synchronous motor d-axis inductance	Set the synchronous motor d-axis inductance	Model settings (0.001~655.35mH)	Changeable only at stop
A03.22 (0x2316)	Synchronous motor q-axis inductance	Set the synchronous motor q-axis inductance	Model settings (0.001~655.35mH)	Changeable only at stop
A03.23 (0x2317)	Synchronous motor back electromotive force	Set the synchronous motor back electromotive force	Model settings (0.1~6553.5V)	Changeable only at stop
A03.24 (0x2318)	Encoder installation angle	Set the synchronous motor encoder installation angle	Model settings (0.0~359.9°)	Changeable only at stop
A03.25 (0x2319)	Initial position detection current	Set the initial position detection current	80% (50~150%)	Changeable only at stop
A03.26 (0x231A)	Initial position detection selection	0: Detect before each run 1: No detect 2: First power on operation detection	0 (0~2)	Changeable only at stop

7.25 Group A04: Motor 2 encoder parameters

Parameter (address)	Name	Reference	Default (Setup range)	Adjustable properties
A04.00 (0x2400)	Speed feedback encoder type	0: ABZ incremental encoder 1: UW encoder 2: Rotary transformer encoder	0 (0~2)	Changeable only at stop
A04.01 (0x2401)	Encoder line number	Set the number of encoder lines	1024 (1~20000)	Changeable only at stop
A04.02 (0x2402)	Encoder direction	0: Same direction 1: Opposite direction	0 (0~1)	Changeable only at stop
A04.03 (0x2403)	Gear ratio molecule	Set the gear ratio molecule	1 (1~32767)	Changeable only at stop
A04.04 (0x2404)	Gear ratio denominator	Set the gear ratio denominator	1 (1~32767)	Changeable only at stop
A04.06 (0x2406)	Encoder pulse cutoff frequency	Set the encoder pulse cutoff frequency	200KHz (50~500KHz)	Changeable only at stop
A04.10 (0x240A)	Encoder disconnection detection time	Set the encoder disconnection detection time	1.00s (0.10s~10.00s)	Changeable only at stop

7.26 Group A05: Motor 2 V/F control parameters

Parameter (address)	Name	Reference	Default (Setup range)	Adjustable properties
A05.00 (0x2500)	V/F curve selection	0: Straight line V/F curve 1: Customized V/F curve 2: 1.2 times V/F curve 4: 1.4 times V/F curve 6: 1.6 times V/F curve 8: 1.8 times V/F curve 10: Square V/F curve 11: VF complete separation mode 12: VF semi-separated mode	0 (00~12)	Changeable only at stop
A05.01 (0x2501)	Multi-point VF voltage value V1	Set multi-point VF voltage value V1	0.0% (0.0%~100.0%)	Changeable only at stop
A05.02 (0x2502)	Multi-point VF frequency value F1	Set multi-point VF frequency value F1	0.00Hz (0.00Hz~)	Changeable only at stop
A05.03 (0x2503)	Multi-point VF voltage value V2	Set multi-point VF voltage value V2	0.0% (0.0%~100.0%)	Changeable only at stop
A05.04 (0x2504)	Multi-point VF frequency value F2	Set multi-point VF frequency value F2	0.00Hz (0.00Hz~A05.06)	Changeable only at stop
A05.05 (0x2505)	Multi-point VF voltage value V3	Set multi-point VF voltage value V3	0.0% (0.0%~100.0%)	Changeable only at stop
A05.06 (0x2506)	Multi-point VF frequency value F3	Set multi-point VF frequency value F3	0.00Hz (A05.04~F01.11)	Changeable only at stop
A05.07 (0x2507)	Torque boost	In the case of low frequency, by setting this parameter, the output voltage of the inverter is increased, so that the current is increased and the output torque is increased. (0.0%: automatic torque boost)	Motor Power 5.5KW and below: 2.0% 7.5KW and above: 1.0% (0.0%~30.0%)	Changeable at any time

A05.08 (0x2508)	Torque boost cutoff frequency	Set the effective range of the torque boost function. When the output frequency exceeds this value, the torque boost function is cut off.	20.00Hz (0.00Hz~F01.11)	Changeable at any time
A05.09 (0x2509)	Slip compensation gain	Set slip compensation gain	0.0% (0.0%~200.0%)	Changeable at any time
A05.10 (0x250A)	Slip compensation limiter	Set the slip compensation limit value (rated slip)	200.0% (0.0%~200.0%)	Changeable at any time
A05.11 (0x250B)	Slip compensation filter time	The slip compensation function requires correct input of motor nameplate parameters and parameter learning to achieve the best effect.	0.100s (0.000~1.000s)	Changeable at any time
A05.12 (0x250C)	Online torque compensation gain 1	Set online torque compensation gain 1	130 (100~150)	Changeable at any time
A05.13 (0x250D)	Online torque compensation gain 2	Set online torque compensation gain 2	100 (50~150)	Changeable at any time
A05.14 (0x250E)	Overexcitation gain	Set the overexcitation gain, the larger it is, the stronger the suppression effect will be.	100 (0~200)	Changeable at any time
A05.15 (0x250F)	Oscillation suppression mode	0: invalid 1~4: Mode 1~4	1 (0~4)	Changeable at any time
A05.16 (0x2510)	Oscillation suppression gain	By adjusting this value, low-frequency resonance can be suppressed, but it cannot be too large, otherwise it will cause additional stability problems.	40 (0~200)	Changeable at any time
A05.20 (0x2514)	VF separated voltage source	0: Digital setting (A05.21) 1: All given 2: AI2 given 3: AI3 given 4: Keyboard potentiometer given 5: Communication given 6: PULSE pulse setting (DI6) 7: PID given 8: Multi-speed command	0 (0~8)	Changeable at any time
A05.21 (0x2515)	VF separated voltage digital setting	Set the VF separation output voltage digital	0V (0V~A03.03)	Changeable at any time
A05.22 (0x2516)	VF separation voltage acceleration time	Set VF separation voltage acceleration time	0.0s (0.0s~1000.0s)	Changeable at any time
A05.23 (0x2517)	VF separation voltage deceleration time	Set VF separation voltage deceleration time	0.0s (0.0s~1000.0s)	Changeable at any time
A05.24 (0x2518)	VF separation shutdown mode selection	0: Frequency/voltage independently reduced to 0 1: After the voltage decreases to 0, the frequency decreases again.	0 (0~1)	Changeable at any time
A05.30 (0x251E)	VF energy saving control	0: Disable energy saving control 1: Automatic energy saving control 2: Manual energy-saving control Use energy-saving control with caution when the load changes frequently.	0 (0~2)	Changeable at any time

A05.31 (0x251F)	VF energy saving coefficient	During manual energy-saving control, set the energy-saving control coefficient. The smaller the value, the more obvious the energy-saving effect, but the greater the sudden load speed drop.	50.0% (20.0%~100.0%)	Changeable at any time
A05.32 (0x2520)	VF energy saving control KP	Set the proportional gain of VF energy-saving control voltage adjustment.	500 (0~2000)	Changeable at any time
A05.33 (0x2521)	VF energy saving control KI	Set the integral coefficient of VF energy-saving control voltage adjustment.	800 (0~2000)	Changeable at any time

7.27 Group A06: Motor 2 speed loop and torque control parameters

Parameter (address)	Name	Reference	Default (Setup range)	Adjustable properties
A06.00 (0x2600)	Low speed speed loop proportional gain	Set low speed speed loop proportional gain	40 (1~500)	Changeable at any time
A06.01 (0x2601)	Low speed speed loop integration time	Set low speed speed loop integration time	0.20s (0.01s~5.00s)	Changeable at any time
A06.02 (0x2602)	High speed speed loop proportional gain	Set high-speed speed loop proportional gain	30 (1~500)	Changeable at any time
A06.03 (0x2603)	High speed speed loop integration time	Set the high-speed speed loop integration time	0.50s (0.01s~5.00s)	Changeable at any time
A06.04 (0x2604)	Switch frequency 1	Set speed loop switching frequency 1	5.00Hz (0.00Hz~A06.05)	Changeable at any time
A06.05 (0x2605)	Switching frequency 2	Set speed loop switching frequency 2	10.00Hz (A06.04~F01.11)	Changeable at any time
A06.06 (0x2606)	Slip compensation gain	Set slip compensation gain	100% (50%~200%)	Changeable at any time
A06.07 (0x2607)	Speed feedback filter time	Set speed feedback filter time	15ms (5~100ms)	Changeable at any time
A06.08 (0x2608)	Speed loop integral separation	0: No separation 1: Integral separation	0 (0~1)	Changeable only at stop
A06.10 (0x260A)	Torque lock selection under speed control	0: Not locked 1: The electric generator torque lock is the setting channel of A06.11	0 (0~1)	Changeable only at stop
A06.11 (0x260B)	Torque upper limit source under speed control (electric)	0: Digital setting (A06.12) 1: AI1 given 2: AI2 given 3: AI3 given 4: Keyboard potentiometer given 5: Communication given 6: PULSE pulse setting (DI6)	0 (0~6)	Changeable only at stop
A06.12 (0x260C)	Torque upper limit setting under speed control (electric)	Set the upper limit of torque under speed control (electric)	180.0% (0.0%~300.0%)	Changeable at any time
A06.13 (0x260D)	Torque upper limit source under speed control (power generation)	0: Digital setting (A06.14) 1: AI1 given 2: AI2 given 3: AI3 given	0 (0~6)	Changeable only at stop

		4: Keyboard potentiometer given 5: Communication given 6: PULSE pulse setting (DI6)		
A06.14 (0x260E)	Torque upper limit setting under speed control (power generation)	Set the upper limit of torque under speed control (power generation)	180.0% (0.0%~300.0%)	Changeable at any time
A06.30 (0x261E)	Torque control selection	0: Speed control 1: Torque control	0 (0~1)	Changeable only at stop
A06.31 (0x261F)	Torque setting source selection	0: Digital setting (A06.32) 1: AI1 given 2: AI2 given 3: AI3 given 4: Keyboard potentiometer given 5: Communication given 6: PULSE pulse setting (DI6)	0 (0~6)	Changeable only at stop
A06.32 (0x2620)	Torque digital setting	Set keyboard digital given torque	0.0% (-300.0%~300.0%)	Changeable at any time
A06.34 (0x2622)	Torque acceleration time	Set torque acceleration time	1.00 (0.00~600.00s)	Changeable at any time
A06.35 (0x2623)	Torque deceleration time	Set torque deceleration time	1.00 (0.00~600.00s)	Changeable at any time
A06.38 (0x2626)	Speed limit source selection	0: Digital limit (A06.39 and A06.40) 1: Upper limit frequency limit 2: AI1 given 3: AI2 given 4: AI3 given 5: Keyboard potentiometer limitation 6: Communication given 7: PULSE pulse setting (DI6)	0 (0~7)	Changeable at any time
A06.39 (0x2627)	Forward speed limit digital setting	Set the limit value of forward speed given by keyboard numbers	50.00Hz (0.00~F01.11)	Changeable at any time
A06.40 (0x2628)	Negative speed limit digital setting	Set the limit value of negative speed given by keyboard numbers	50.00Hz (0.00~F01.11)	Changeable at any time

7.28 Group A07: Motor 2 current loop and magnetic flux control parameters

Parameter (address)	Name	Reference	Default (Setup range)	Adjustable properties
A07.00 (0x2700)	Current loop excitation axis proportional gain	Set the current loop excitation axis proportional gain	2000 (0~60000)	Changeable at any time
A07.01 (0x2701)	Current loop excitation axis integral gain	Set the current loop excitation axis integral gain	1000 (0~60000)	Changeable at any time
A07.02 (0x2702)	Current loop torque axis proportional gain	Set the current loop torque axis proportional gain	2000 (0~60000)	Changeable at any time
A07.03 (0x2703)	Current loop torque axis integral gain	Set the current loop torque axis integral gain	1000 (0~60000)	Changeable at any time

7.29 Group D0x: Monitoring parameters

7.29.1 Group D00: Status monitoring parameters

Parameter (address)	Name	Parameter (address)	Name
D00.00 (0x6000)	Main setting frequency	D00.30 (0x601E)	VF separation target voltage
D00.01 (0x6001)	Auxiliary setting frequency	D00.31 (0x601F)	VF split output voltage
D00.02 (0x6002)	Frequency command (after acceleration and deceleration)	D00.32 (0x6020)	Communication settings
D00.03 (0x6003)	Set frequency	D00.33 (0x6021)	PID given
D00.04 (0x6004)	Output frequency	D00.34 (0x6022)	PID feedback
D00.05 (0x6005)	The output voltage	D00.35 (0x6023)	PID error
D00.06 (0x6006)	Output current	D00.36 (0x6024)	PID integral item
D00.07 (0x6007)	bus voltage	D00.37 (0x6025)	PID output
D00.08 (0x6008)	Given torque	D00.38 (0x6026)	PLC stage
D00.09 (0x6009)	Output torque	D00.39 (0x6027)	External count value
D00.10 (0x600A)	Output Power	D00.40 (0x6028)	Actual length
D00.11 (0x600B)	Set speed	D00.44(0x602C)	power factor angle
D00.12 (0x600C)	Running speed	D00.45 (0x602D)	Observe motor frequency (SVC)
D00.13 (0x600D)	Inverter running status	D00.46 (0x602E)	Encoder feedback frequency
D00.14 (0x600E)	Inverter temperature	D00.47 (0x602F)	Load display speed
D00.16 (0x6010)	DI input status	D00.48 (0x6030)	Encoder position information
D00.17 (0x6011)	DO output status	D00.49 (0x6031)	Synchronized rotor position
D00.18 (0x6012)	AI1 voltage (before correction)	D00.50 (0x6032)	Z pulse cumulative error
D00.19 (0x6013)	AI1 voltage (after correction)	D00.51 (0x6033)	Z pulse count
D00.20 (0x6014)	AI2 voltage (before correction)	D00.52 (0x6034)	U phase sampling value
D00.21 (0x6015)	AI2 voltage (after correction)	D00.54 (0x6036)	W phase sampling value
D00.22 (0x6016)	AI3 voltage (before correction)	D00.55 (0x6037)	Current fault
D00.23 (0x6017)	AI3 voltage (after correction)	D00.56 (0x6038)	Remaining run time
D00.24 (0x6018)	Keyboard potentiometer voltage (before correction)	D00.57 (0x6039)	Running time accumulation
D00.25 (0x6019)	Keyboard potentiometer voltage (after correction)	D00.58 (0x603A)	Accumulated power-on time
D00.26(0x601A)	AO1 output	D00.59 (0x603B)	High cumulative energy consumption of the motor
D00.27 (0x601B)	AO2 output	D00.60 (0x603C)	Motor cumulative energy consumption is low
D00.28 (0x601C)	High-speed pulse input frequency	D00.61 (0x603D)	High energy consumption during this operation
D00.29 (0x601D)	High-speed pulse output frequency	D00.62 (0x603E)	Low energy consumption during this operation

7.29.2 Group D01: Fault monitoring parameters

Parameter (address)	Name	Parameter (address)	Name
---------------------	------	---------------------	------

D01.00 (0x6100)	Last fault type	D01.36 (0x6118)	Last three fault types
D01.01 (0x6101)	Frequency reference upon the active fault	D01.37 (0x6119)	Set the frequency for the last three failures
D01.02 (0x6102)	Output frequency upon the active fault	D01.38 (0x611A)	Output frequency for the last three failures
D01.03 (0x6103)	Output voltage upon the active fault	D01.39 (0x611B)	Output voltage for the last three failures
D01.04 (0x6104)	Output current upon the active fault	D01.40 (0x611C)	Output current for the last three failures
D01.05 (0x6105)	Bus voltage upon the active fault	D01.41 (0x611D)	Bus voltage for the last three failures
D01.06 (0x6106)	Inverter temperature upon the active fault	D01.42 (0x611E)	Inverter temperature for the last three failures
D01.07 (0x6107)	Input terminal state upon the active fault	D01.43 (0x611F)	Enter the terminal status for the last three failures
D01.08 (0x6108)	Output terminal state upon the active fault	D01.44 (0x6120)	Output terminal status for the last three failures
D01.09 (0x6109)	AC driver state upon the active fault	D01.45 (0x6121)	Inverter status for the last three failures
D01.10 (0x610A)	Power-on duration upon the active fault	D01.46 (0x6122)	Power-on time for the last three failures
D01.11 (0x610B)	Running duration upon the active fault	D01.47 (0x6123)	Running time for the last three failures
D01.12 (0x610C)	Latest fault	D01.48 (0x6118)	Last four fault types
D01.13 (0x610D)	Frequency reference of the latest fault	D01.49 (0x6119)	Set the frequency for the last four failures
D01.14 (0x610E)	Output frequency of the latest fault	D01.50 (0x611A)	Output frequency for the last four failures
D01.15 (0x610F)	Output voltage of the latest fault	D01.51 (0x611B)	Output voltage for the last four failures
D01.16 (0x6110)	Output current of the latest fault	D01.52 (0x611C)	Output current for the last four failures
D01.17 (0x6111)	Bus voltage of the latest fault	D01.53 (0x611D)	Bus voltage for the last four failures
D01.18 (0x6112)	Inverter temperature of the latest fault of last failure	D01.54 (0x611E)	Inverter temperature for the last four failures
D01.19 (0x6113)	Input terminal state of the latest fault	D01.55 (0x611F)	Enter the terminal status for the last four failures
D01.20 (0x6114)	Output terminal state of the latest fault	D01.56 (0x6120)	Output terminal status for the last four failures
D01.21 (0x6115)	AC driver state of the latest fault	D01.57 (0x6121)	Inverter status for the last four failures
D01.22 (0x6116)	Power-on duration of the latest fault	D01.58 (0x6122)	Power-on time for the last four failures
D01.23 (0x6117)	Running duration of the latest fault	D01.59 (0x6123)	Running time for the last four failures
D01.24 (0x6118)	Second latest fault	D01.60 (0x6118)	Last five fault types
D01.25 (0x6119)	Frequency reference of the second latest fault	D01.61 (0x6119)	Set the frequency for the last five failures
D01.26 (0x611A)	Output frequency of the second latest fault	D01.62 (0x611A)	Output frequency for the last five failures

D01.27 (0x611B)	Output voltage of the second latest fault	D01.63 (0x611B)	Output voltage for the last five failures
D01.28 (0x611C)	Output current of the second latest fault	D01.64 (0x611C)	Output current for the last five failures
D01.29 (0x611D)	Bus voltage of the second latest fault	D01.65 (0x611D)	Bus voltage for the last five failures
D01.30 (0x611E)	Inverter temperature of the second latest fault of last failure	D01.66 (0x611E)	Inverter temperature for the last five failures
D01.31 (0x611F)	Input terminal state of the second latest fault	D01.67 (0x611F)	Enter the terminal status for the last five failures
D01.32 (0x6120)	Output terminal state of the second latest fault	D01.68 (0x6120)	Output terminal status for the last five failures
D01.33 (0x6121)	AC driver state of the second latest fault	D01.69 (0x6121)	Inverter status for the last five failures
D01.34 (0x6122)	Power-on duration of the second last fault	D01.70 (0x6122)	Power-on time for the last five failures
D01.35 (0x6123)	Running duration of the second latest fault	D01.71 (0x6123)	Running time for the last five failures

7.29.3 Group D02: System information

Parameter (address)	Name	Parameter (address)	Name
D02.00 (0x6200)	AC drive series	D02.06 (0x6206)	Non-stand software version of control board
D02.01 (0x6201)	Rated power of AC drive	D02.08 (0x6208)	Software version of operating panel
D02.02 (0x6202)	Rated voltage of AC drive	D02.09 (0x6209)	Customized series number
D02.03 (0x6203)	Rated current of AC drive	D02.10(0x620A)	Internal version of control board
D02.04 (0x6204)	Software version of control board		

7.30 Input terminal function

DI Selection	Reference	DI Selection	Reference	DI Selection	Reference
0	No function	18	External fault normally closed input	35	PID points suspended
1	Forward running (FWD)	19	User defined fault	36	PID pause
2	Reverse operation (REV)	20	Motor 1/2 switching	37	PID parameter switching
3	Three-wire operation control	21	Multi-speed command terminal 1	38	PID action direction is reversed
4	Forward jog	22	Multi-speed command terminal 2	39	PLC status reset
5	Reverse jog	23	Multi-speed command terminal 3	40	Swing frequency input
6	Free parking	24	Multi-speed command terminal 4	41	Swing frequency pause
7	Emergency pull over	25	Terminal UP	42	Swing frequency

					reset
8	Command channel local and remote switching	26	Terminal DOWM	43	Counter input (DI6)
9	Command channel and terminal communication switching	27	UP/DOWN setting clear (terminal, keyboard)	44	Counter reset
10	External parking terminal	28	Channel X switches to channel Y	45	length count input
12	Immediate DC braking	29	Frequency source X and initial frequency switching	46	Length reset
13	Deceleration DC braking	30	Frequency source Y and initial frequency switching	47	High-speed pulse input (DI6)
14	Run pause	31	Frequency modification enabled	48	Zero servo enable
15	Inversion prohibited	32	Acceleration and deceleration time selection terminal 1	49	Torque control disabled
16	Fault reset (RESET)	33	Acceleration and deceleration time selection terminal 2	50	Speed control/torque control switching
17	External fault normally open input	34	Acceleration and deceleration pause	51	This running time is cleared to zero

7.31 Output terminal function

DI Selection	Reference	DI Selection	Reference	DI Selection	Reference
0	No output	13	Frequency converter load loss	25	Set count value reached
1	Ready to run	14	Undervoltage status output	26	The specified count value is reached
2	The inverter is running	15	Frequency level detection FDT1 output	27	length reached
3	The frequency converter is running forward	16	Frequency level detection FDT2 output	28	Motor over temperature warning
4	The inverter is running in reverse rotation	17	frequency arrival	29	The module temperature reaches
5	The inverter is running at zero speed (stop is invalid)	18	Swing frequency is limited	30	Output current exceeds limit
6	The inverter is running at zero speed (valid when stopped)	19	Torque is limited	31	PLC cycle completed
7	zero current state	20	Upper limit frequency reached	32	Timing to reach output

8	Frequency converter fault output	21	Lower limit frequency reached (running state)	33	This running time arrives
9	Frequency converter alarm output	22	Any frequency reaches the output	34	Accumulated running time reached
11	Motor overload warning	23	Any current reaches the output	35	Accumulated power-on time reached
12	Frequency converter overload warning	24	Communication settings		

7.32 Fault code table

Operating panel display	Fault name	Operating panel display	Fault name
E0001	Acceleration overcurrent	E0024	Motor overload
E0002	Deceleration overcurrent	E0025	Load loss
E0003	Constant speed overcurrent	E0026	Inverter overheat
E0004	Acceleration overvoltage	E0028	External failure
E0005	Deceleration overvoltage	E0029	Communication timeout
E0006	Constant speed overvoltage	E0030	EEPROM read/write fault
E0007	Undervoltage at running	E0031	PID feedback loss
E0009	Output interphase short	E0032	Accumulative running duration reach
E0010	Motor short-to-ground	E0033	Accumulative power-on duration reach
E0011	Current detection exception	E0034	User defined fault
E0012	Pause-by-pulse current limit fault	E0040	Encoder fault
E0013	Motor auto-tuning exception	E0041	Excessive speed deviation
E0014	Input phase loss	E0042	Motor overspeed fault
E0015	Output phase loss	E0050	Synchronous motor initial pole position detection fault
E0018	Pre-charge resistor overload	E0060	Synchronous motor abnormal back electromotive force fault
E0023	AC driver overload		

8 Inspection, maintenance and assurance

8.1 Inspection

AC drives are composed of semiconductor devices, passive electronic devices, and moving devices, and these devices have a service life, even under normal working conditions, if the service life is exceeded, some devices may change characteristics or fail. In order to prevent this phenomenon from leading to failure, preventive inspection and maintenance such as daily inspection, regular inspection and device replacement must be carried out. It is recommended to check the machine every 3 to 4 months after installation.

Daily inspection: In order to avoid damage to the inverter and shorten the service life, please confirm the following items every day.

Table 8-1 Daily check items and countermeasures

Check Items	Check the contents	Coping strategies
Power supply	Check whether the power supply voltage meets the requirements and there is no phase power supply.	Solve according to the requirements of the nameplate.
Surroundings	Whether the installation environment meets requirements.	Identify the source and resolve it properly.
Cooling system	Inverter and motor whether there is abnormal heating and discoloration phenomenon, cooling fan working condition.	Check whether it is overloaded, tighten the screws, check whether the heat sink of the inverter is dirty, and check whether the fan is blocked.
Motors	Whether the motor has abnormal vibration and abnormal sound.	Tighten mechanical and electrical connections and lubricate mechanical parts.
Load conditions	Whether the AC drive output current is higher than the motor or AC drive rating and has lasted for a certain time.	Confirm whether overload occurs and confirm whether the selection of inverter is correct.

Regular inspection: Under normal circumstances, it is appropriate to carry out a regular inspection every 3 months to 4 months, but in actual circumstances, please determine the actual inspection cycle according to the use of each machine and the working environment.

Table 8-2 Regular inspection items and coping strategies

Check Items	Check the contents	Coping strategies
Overall	<ul style="list-style-type: none"> ● Insulation resistance check; ● Environmental inspection. 	<ul style="list-style-type: none"> ● Tighten and replace defective parts; ● Clean and improve the operating environment.
Electrical connection	<ul style="list-style-type: none"> ● Wires and connecting parts are discolored, insulation is damaged, cracked, discolored and aging and other traces; ● Whether the connection terminal is worn, damaged, loose; ● Grounding check. 	<ul style="list-style-type: none"> ● Replace damaged wires; ● Tighten loose terminals and replace damaged terminals; ● Measure the grounding resistance and tighten the corresponding grounding terminal.
Mechanical connection	<ul style="list-style-type: none"> ● Whether there is abnormal vibration and sound, whether the fixing is loose. 	<ul style="list-style-type: none"> ● Tighten, lubricate and replace bad parts.
Semiconductor devices	<ul style="list-style-type: none"> ● Whether it is stained with garbage and dust; ● Whether there is a noticeable change in appearance. 	<ul style="list-style-type: none"> ● Clean operating environment; ● Replace damaged parts.

Electrolytic capacitance	<ul style="list-style-type: none"> Whether there is leakage, discoloration, cracking, whether the safety valve is exposed, expanded, cracked or leaking. 	<ul style="list-style-type: none"> Replace damaged parts.
Peripherals	<ul style="list-style-type: none"> Peripheral equipment appearance and insulation inspection. 	<ul style="list-style-type: none"> Clean the environment and replace damaged parts.
Printed circuit board	<ul style="list-style-type: none"> Whether there is an odor, discoloration, severe rust, and whether the connector is correct and reliable. 	<ul style="list-style-type: none"> Fastening connectors; Clean the printed circuit board; Replace the damaged printed circuit board.
Cooling system	<ul style="list-style-type: none"> Cooling fan is damaged and blocked phenomenon; Whether the heat sink is stained with garbage and dust, whether it is dirty; Whether the air intake and exhaust ports are blocked or stained with foreign bodies. 	<ul style="list-style-type: none"> Clean the operating environment; Replace damaged parts.
Keyboard	<ul style="list-style-type: none"> Keyboard is broken and display is incomplete. 	<ul style="list-style-type: none"> Replace damaged parts.
Motor	<ul style="list-style-type: none"> Whether the motor has abnormal vibration and abnormal sound. 	<ul style="list-style-type: none"> Tighten mechanical and electrical connections and lubricate motor shafts.

Attention!

Do not perform related operations in the state of power on, otherwise there is a risk of electrocution and death!

When performing related operations, please cut off the power supply, and confirm that the main circuit DC voltage has dropped to a safe level, wait 5 minutes before performing related operations!

Note

8.2 Maintenance

All the equipment and parts have a service life, the correct maintenance can extend the life, but can not solve the damage of the equipment and components, please replace the components according to the requirements.

Part	Life cycle	Part name	Life cycle	Part name	Life cycle
Fan	2 to 3 years	Electrolytic	4 to 5 years	Printed circuit board	8 to 10 years

The replacement of other components is very strict on the maintenance technology and product familiarity, and it must be strictly tested before it can be put into use after replacement, so it is not recommended that users replace other internal components by themselves. If you do need to replace, please contact the agent from which you purchased the product or the sales department of the company.

8.3 Product Warranty

1. If the product fails during the warranty period, the warranty scope is detailed in the warranty clause in the warranty card.

2. Primary fault diagnosis, in principle, is carried out by your company, but can be provided by our company or our service network for a fee according to your company's request. According to the result of negotiation with your company, if the fault is caused by our company, we will provide free service.

3. Liability exemption. The inconvenience caused to you or your customers and the damage caused to non-our products due to the failure of our products, whether within the warranty period or not, shall not fall within the scope of our company's liability.

9 Accessory Recommendation

9.1 Braking Resistors

Table 9-1 Braking resistors table

AC drive type	brake unit	Brake resistor			
		Standard resistance value	Count	Resistance value Min limit value	Standard power
KC200-2S-0R40G	Standard built-in	200Ω	1	100Ω	100W
KC200-2S-0R75G		150Ω	1	100Ω	150W
KC200-2S-01R5G		150Ω	1	100Ω	150W
KC200-2S-02R2G		50Ω	1	35Ω	400W
KC200-4T/5T-0R75G		750Ω	1	125Ω	110W
KC200-4T/5T-01R5G		400Ω	1	100Ω	260W
KC200-4T/5T-02R2G		250Ω	1	100Ω	320W
KC200-4T/5T-03R7G		150Ω	1	66.7Ω	550W
KC200-4T/5T-05R5G		100Ω	1	66.7Ω	800W
KC200-4T/5T-07R5G		75Ω	1	66.7Ω	1070W
KC200-4T/5T-0011G		50Ω	1	25Ω	1600W
KC200-4T/5T-0015G		40Ω	1	25Ω	2000W
KC200-4T/5T-0018G		32Ω	1	20Ω	4800W
KC200-4T/5T-0022G		27.2Ω	1	20Ω	4800W
KC200-4T/5T-0030G		20Ω	1	14Ω	6000W
KC200-4T/5T-0037G		16Ω	1	14Ω	9600W
KC200-4T/5T-0045G		15Ω	1	13.6Ω	9600W

9.2 EMC Filter

In order for the KC200 series to meet the radiation and conductive emission requirements of the EN IEC 61800-3 standard, an externally adapted EMC filter is required. The EMC filter models available to customers in this series are listed below, and these filters meet the CE certification EN 61800-3 Class C2 emission requirements.

Note

Attention!

The connection cable between the filter and the device must be as short as possible, which should be less than 30cm. The filter and the device should be connected to the unified grounding reference surface, and the grounding of the filter output terminal should be connected to the input grounding terminal of the frequency converter to ensure the reliable grounding of the filter, otherwise the filtering function of the filter cannot be played.

9.2.1 External filters are available for single-phase models

Table 9-2 EMC Filter selection (single-phase 200V~240V)

Model	Power (kW)	Specification	Rated current(A)	Order number
KC200-2S-0R40G	0.4	ME440-5	5	18.2.01.0216
KC200-2S-0R75G	0.75	ME440-10	10	18.2.01.0215
KC200-2S-01R5G	1.5	ME440-20	20	18.2.01.0214
KC200-2S-02R2G	2.2	ME440-20	20	18.2.01.0214

9.2.2 External filters are available for three-phase models

Table 9-3 EMC Filter selection (three-phase 38V~480V)

Model	Power (kW)	Specification	Rated current (A)	Order number
KC200-4T/5T-0R75G	0.75	ME466-5	5	18.2.01.0211
KC200-4T/5T-01R5G	1.5	ME466-5	5	18.2.01.0211
KC200-4T/5T-02R2G	2.2	ME466-10	10	18.2.01.0212
KC200-4T/5T-03R7G	3.7	ME466-10	10	18.2.01.0212
KC200-4T/5T-05R5G	5.5	ME466-20	20	18.2.01.0213
KC200-4T/5T-07R5G	7.5	ME466-20	20	18.2.01.0213
KC200-4T/5T-0011G	11	ME920-30	30	18.2.01.0217
KC200-4T/5T-0015G	15	ME920-30	30	18.2.01.0217
KC200-4T/5T-0018G	18.5	ME920-45	45	18.2.01.0218
KC200-4T/5T-0022G	22	ME920-45	45	18.2.01.0218
KC200-4T/5T-0030G	30	ME920-75	75	18.2.01.0219
KC200-4T/5T-0037G	37	ME920-75	75	18.2.01.0219
KC200-4T/5T-0045G	45	ME920-100	100	18.2.01.0220
KC200-4T/5T-0055G	55	ME920-120	120	18.2.01.0221
KC200-4T/5T-0075G	75	ME920-150	150	18.2.01.0222
KC200-4T/5T-0090G	90	ME920-200	200	18.2.01.0223
KC200-4T/5T-0110G	110	ME920-250	250	18.2.01.0224
KC200-4T/5T-0132G	132	ME920-300	300	18.2.01.0225
KC200-4T/5T-0160G	160	ME920-300	300	18.2.01.0225
KC200-4T/5T-0185G	185	ME920-420	420	18.2.01.0226
KC200-4T/5T-0200G	200	ME920-420	420	18.2.01.0226
KC200-4T/5T-0220G	220	ME920-420	420	18.2.01.0226
KC200-4T/5T-0250G	250	ME920-500	500	18.2.01.0227
KC200-4T/5T-0280G	280	ME920-600	600	18.2.01.0228
KC200-4T/5T-0315G	315	ME920-600	600	18.2.01.0228
KC200-4T/5T-0355G	355	ME920-800	800	18.2.01.0229
KC200-4T/5T-0400G	400	ME920-800	800	18.2.01.0229
KC200-4T/5T-0450G	450	ME920-1000	1000	18.2.01.0230
KC200-4T/5T-0500G	500	ME920-1000	1000	18.2.01.0230
KC200-4T/5T-0560G	560	ME920-1100	1100	18.2.01.0231

9.2.3 Installation requirement

- EMC filter should be installed close to the input terminal of the device, and the cable between them should be smaller than 30cm.
- Connect the ground terminal of the EMC filter to the ground terminal of the device, and ensure that the filter and device are installed on the same conductive installation plane, which is connected to the main grounding of the cabinet.
- The upper LINE end of the EMC filter should be connected to the power grid, and the LOAD end should be connected to the device.

9.3 Common EMC problems and solutions

9.3.1 Ground cables and grounding issues

Influence factor	Solution
The ground points of different devices are different	The common grounding system is used to ensure that the ground potential of all devices is the same.
If multiple devices share the same ground point, interference on one device affects other devices	Use isolation transformers to reduce the propagation of common site interference
There is unnecessary electromagnetic interference in the circuit	Use shielding technology to block external interference and reduce electromagnetic radiation and electromagnetic induction

9.3.2 ESD discharge issues

Influence factor	Solution
Moving or touching equipment when the human body is charged	Use ESD eliminators, ESD floors, and ESD shoe covers
There is a potential difference between different devices	Ensure that devices are properly grounded and that all devices are connected to the same ground point
Static electricity builds up around the device	Add an anti-static coating and clean the surface of the device regularly
The external environment is dry and the device is rubbed	Use an ESD floor and control the humidity

9.3.3 Transient interference

Influence factor	Solution
Switching operation causes sudden voltage or current change	a. Use capacitors or inductors to eliminate or attenuate b. Filter or discharge resistance is used to suppress
The device starts and stops suddenly, causing sudden changes in the power load	a. Use power filters and regulators for smooth power supply b. Soft start or soft stop technology is used to realize the smooth change of load
Lightning strikes or discharges in the atmosphere	a. Use lightning arresters, lightning protection devices and power filters b. Wrap insulation or shielding around the equipment
During signal transmission, it is subjected to transient interference from other devices or external environment	Use shielded cables or electromagnetic shielding enclosures to protect against external transient interference

9.3.4 Harness interference

Influence factor	Solution
The harness is too long or too dense	a. Shorten the length of the wire harness and minimize the cross and overlap of the wire harness b. Separate the wire harness to avoid excessive proximity between different types of wire harnesses
The device starts and stops suddenly, causing sudden changes in the power load	a. Make sure all wiring harnesses are properly and well grounded and connect them to the same ground point b. Select harnesses that use shielded grounding technology or electromagnetic shielding materials
Lightning strikes or discharges in the atmosphere	a. Use filters to reduce power supply noise and electromagnetic radiation in the harness b. Choose a harness that uses electromagnetic shielding materials

During signal transmission, it is subjected to transient interference from other devices or external environment	a. Select suitable wire harness materials, such as shielded wire harnesses with anti-interference characteristics or materials with low electromagnetic radiation b. Wire harness should have anti-interference design, choose the appropriate structure
--	---

9.3.5 Power supply fluctuation and inrush current

Influence factor	Solution
The device suddenly starts and stops	a. Use equipment such as filters, regulators or capacitors to smooth load changes b. Use soft start or soft stop technology to achieve smooth load changes
The voltage provided by the external power supply is unstable	Use a power regulator
Insufficient power supply capacity, especially when starting with high-power loads	a. Periodically evaluate the power capacity b. Avoid overload

9.3.6 Leakage protection circuit breaker works incorrectly

If a circuit breaker with leakage protection is used in the device, and the fault occurs, please use the following methods to solve the problem.

Leakage protector tripping phenomenon	Influence factor	Solution
The leakage protector is tripped at the moment of power-on	The anti-interference performance of leakage protection is poor	a. Use the recommended brand of leakage protection circuit breaker
	The leakage protection action current is too small	b. Replace with a leakage protection circuit breaker with a larger operating current.
	An unbalanced load is connected to the back-end	c. Transfer the unbalanced load to the front end of the leakage protection circuit breaker
	The front end of the device has a large ground capacitance	d. Try to disconnect the EMC screw or the ground end of the external EMC filter to reduce the capacitance of the input end to the ground
Leakage protector trip during operation	The anti-interference performance of leakage protection is poor	a. Use the recommended brand of leakage protection circuit breaker
	The leakage protection action current is too small	b. If it is a single inverter, ensure that the EMC screws are tightened. If multiple inverters are used, disconnect the EMC optional ground screw
	An unbalanced load is connected to the back-end	c. A simple filter is installed on the input side of the equipment, and a magnetic ring is wound around the LN and RST lines near the leakage protection points.
	The distribution capacitance of the motor cable or motor to the ground is too large	d. Replace with a leakage protection circuit breaker with a larger operating current e. Appropriately reduce the carrier frequency under the premise of ensuring the performance requirements f. Reduce the length of motor cables

9.3.7 Control loop interference

High-speed pulse interference: For this interference, please follow the steps below to rectify

Step	Solution
1	Use shielded twisted pair cables and ground both ends
2	Connect the motor housing to the PE end of the device
3	Connect the PE end of the device to the PE of the power grid
4	The distance between the signal line and the power line is not less than 30cm
5	The signal line increases the magnetic buckle, or the magnetic circle is 1-2 turns
6	The UVW output line of the equipment is added with a magnetic ring and wound for 2-4 turns
7	The shielded power line is adopted, and the shielding layer is well grounded

Ordinary IO signal interference: In the process of use because of wiring, grounding and other problems, there may be interference. If the device interferes with other devices, perform the following steps to rectify the fault.

Step	Solution
1	Use a shielded cable for I/O signal cables, and connect the shielded cable to the PE end
2	The motor PE is reliably connected to the PE end of the device, and the PE end of the device is connected to the grid PE
3	The UVW output line of the equipment is added with a magnetic ring and wound for 2-4 turns
4	Low speed DI with capacitive filter, recommended maximum 0.1uF
5	AI increase capacitive filtering, recommended maximum 0.22uF
6	Add a magnetic buckle or magnetic ring to the signal line and wind 1-2 turns
7	The shielded power line is adopted, and the shielding layer is well grounded

9.3.8 Communication interference

For this interference, please follow the steps below to rectify

Step	Solution
1	Add 120 matching resistors at both ends of the bus
2	Replace the multi-core shielded twisted-pair cable with a dual-terminal grounding cable
3	The distance between the communication cable and the power cable is at least 30cm
4	Add magnetic clasps on both sides of the communication cable, or surround the cable for 1-2 turns
5	The UVW output line of the equipment is added with a magnetic ring and wound for 2-4 turns
6	The shielded power line is adopted, and the shielding layer is well grounded

9.4 Other Optional Accessories

Other optional accessories are listed in the following table. See the instructions for the accessory for detailed usage. If you need the following optional parts, please specify when ordering.

Name	Specification	Function	Order number
External keyboard (without installation box)	NETKEY	External keyboard operation	19.0616
External keyboard (with installation box)	KC100_NETKEY	External keyboard operation	20.0207
Keyboard tray component	FV20-KB-tray	Keyboard installation accessory	18.1.01.2263
8-core flat network cable	Eight-core flat network cable L=200mm	Connect the external keyboard	18.2.07.4352
10-pin network port extension cable	KC200-10PIN cable L=3000	Keyboard extension cable	18.2.07.4389

10 Compliance with certification standards

10.1 CE Certification



- "CE mark" is a mark for commercial trade (production, import, sales) in the European region, indicating that the product meets the safety (LVD), electromagnetic compatibility (EMC), environmental protection (RoHS) and other directives.
- Commercial trade (production, import, sales) in the European region must have CE marking.
- This product complies with the Low Voltage Directive (LVD), Electromagnetic Compatibility (EMC) Directive and Environmental Protection (RoHS) Directive and is CE marked.
- The machinery and devices installed with this product must also meet the CE requirements for sale in Europe.
- When the CE marking is affixed to the terminal on which the product is installed, the responsibility rests with the customer who ultimately assembles the product and verifies that the machinery and devices of the final product comply with the CE certification.

10.2 Meet the requirements of the EMC directive

Note

Attention!

- This product complies with the European EMC directive 2014/35/EU and meets the requirements of standard EN IEC 61800-5-1, suitable for Class I and Class II environments. If used in Class I environments, this product may cause radio interference. In addition to the CE compliance requirements mentioned in this chapter, the User shall also take measures to prevent interference if necessary.
- In order to make the product comply with EMC directives and standards, it is necessary to install an EMC filter on the input side and select the recommended shielded cable on the output side, while ensuring the reliable grounding of the filter and the 360° reliable lap of the shielded layer of the output cable. The manufacturer of the system in which this product is installed is responsible for the compliance of the system with the requirements of the European EMC Directive, and according to the application environment of the system, ensure that the system meets the requirements of the standard EN IEC 61800-5-1.

Appendix 1: Modbus Communication Protocol

● Communication frame structure

The communication data format is as follows:

Byte composition: includes start bit, data bit, check bit, and stop bit.

Start bit	Data bits	Check bit	Stop bit
-----------	-----------	-----------	----------

A frame of information must be transmitted in a continuous stream of data. If more than 1.5 bytes of interval time is passed before the end of the entire frame transmission, the receiving device will erase the incomplete information and mistakenly assume that the next byte is the address domain part of a new frame. Similarly, if the interval between the start of a new frame and the previous frame is less than 3.5 bytes, the receiving device will consider it as a continuation of the previous frame, and the CRC check value will be incorrect due to the confusion of the frame, resulting in a communication error.

Standard structure of RTU frame:

Frame Headers	3.5 bytes of transfer time
Slave address	Mailing address: 0 to 247 (in decimal) (0 indicates the broadcast address)
Command code	03H: Read slave parameters (read up to 12 words consecutively) 06H: Write slave parameters 10H: parameters of continuous write slave
Data area	Parameter address, number of parameters, parameter value, etc
CRC CHK low	Check value: 16-bit CRC check value
CRC CHK high	
Frame End	3.5 bytes of transfer time

● Command code and communication data description

Take reading parameter command code as an example.

For example: the slave address is 01H AC drive, the memory start address is 6000H(monitored parameter D00.00), read three consecutive words, then the structure of the frame is described as follows:

RTU host command information		RTU slave response message (normal)	
Slave address	01H	Slave address	01H
Command code	03H	Command code	03H
Starting address high	60H	number of bytes	06H
Starting address low	00H	Data address 6000H high	13H
Data count high	00H	Data address 6000H low	88H
Data number low	03H	Data Address 6001H high	00H
CRC CHK low	1BH	Data Address 6001H Low	00H
CRC CHK high	CBH	Data Address 6002H high	00H
		Data address 6002H low	00H
		CRC CHK low	C3H
		CRC CHK high	C9H

Write parameter command code consecutively as an example.

For example: the slave address is 01H AC drive, the memory start address is 9101H(multi-speed parameter F17.01, does not store EEPROM, store EEPROM address is 1101H), continuously write 3 words, then the structure of the frame is described as follows:

RTU host command information		RTU slave response information (when normal)	
Slave address	01H	Slave address	01H
Command code	10H	Command code	10H
Starting address high	91H	Starting address high	91H
Starting address low	01H	Starting address low	01H
Data count high	00H	Data count high	00H
Data number low	03H	Data number low	03H
Number of bytes	06H	CRC CHK low	FDH
First data high	00H	CRC CHK high	34H
First data low	64H		
Second data high	00H		
Second data low	C8H		
Third data high	01H		
Third data low	2CH		
CRC CHK low	BEH		
CRC CHK high	C0H		

● Communication control parameter group address description

Function Description	Address definition	Data meaning statement	R/W features
Communication given main frequency	0x7010 (F01.04=5)	0~10000 corresponds to the maximum frequency of 0.00%~100.00% (F01.11)	W
Communication given auxiliary frequency	0x7010 (F01.05=5)	0~10000 corresponds to the maximum frequency of 0.00%~100.00% (F01.11)	W
Communication command setting	0x7000	0x0000: No command 0x0001: Forward running 0x0002: Reverse operation 0x0003: forward jog 0x0004: Reverse jog 0x0005: Deceleration to stop 0x0006: Emergency shutdown 0x0007: Coast to stop 0x0008: Fault reset	W
Communication writing terminal	0x70XX	The low bits of the address are: 01: Write A01 02: Write A02 03: Write D0 04: write pulse output	W
Frequency converter fault code	0x6F00	Current fault code of the inverter (see fault code table)	R

Communication given upper limit frequency	0x7010 (F01.12=5)	0~10000 corresponds to the maximum frequency of 0.00%~100.00% (F01.11)	W
VF separation voltage setting	0x7010 (F05.20=5)	0~10000 corresponds to 0.00%~100.00% of the rated voltage value	W
Torque upper limit source under speed control (electric)	0x7010 (F06.11=5)	0~10000 corresponds to the upper limit setting value of 0.00%~100.00% (F06.12)	W
Torque upper limit source under speed control (power generation)	0x7010 (F06.13=5)	0~10000 corresponds to the upper limit setting value of 0.00%~100.00% (F06.14)	W
Communication given PID setting value	0x7010 (F16.00=5)	0~10000 corresponds to 0.00%~100.00%	W
Communication given PID feedback value	0x7010 (F16.03=4)	0~10000 corresponds to 0.00%~100.00%	W
Multi-speed command 0 frequency setting	0x7010 (F17.00=5)	0~10000 corresponds to the maximum frequency of 0.00%~100.00% (F01.11)	W
Fault status reading	0x61XX	Frequency converter fault status (save the last two faults at most) (see fault code table)	R
Input terminal status	0x6010/0x6013/0x6015/0x6017/0x6019	0x6010: DI terminal input status 0x6013: AI1 terminal input status 0x6015: AI2 terminal input status 0x6017: AI3 terminal input status 0x6019: keyboard potentiometer input status	R
Output terminal status	0x6011/0x601A/0x601B	0x6011: DO terminal output status 0x601A: AO1 terminal output status 0x601B: AO2 terminal output status (0-1000 corresponds to output 0V~10V, 0mA~20mA)	R

Note: For other function code addresses see the "Address" column in the function code brief table.

When using the write command (06H or 10H) to write F00 ~ F15 parameter group parameters, if the function code parameter address field height of half a byte is 8, only write to the inverter RAM, power off is not stored; If the function code parameter address field height half byte is 0, write to EEPROM, that is, power failure storage.

For example, parameters F00.xx: 0x80xx (write RAM), 0x00xx (save to EEPROM); Parameter F01.xx: 0x81xx (write RAM) 0x01xx (store in EEPROM), and so on for other parameter group parameters. When the F00 to F15 parameter group parameters are read, the address height is 0, for example, F03.xx: 0x03xx.

When using the write command (06H or 10H) to write F16 ~ F17 parameter group parameters, if the function code parameter address field height is 9, only write to the AC drive RAM, power off is not stored; If the function code parameter address field height half byte is 1, write to EEPROM, that is, power failure storage.

For example, parameter F16.xx: 0x90xx (write RAM) 0x10xx (save to EEPROM); Parameter F17.xx: 0x91xx (write RAM) 0x11xx (store in EEPROM), and so on for other parameter group parameters. When reading F16 to F17 parameter group parameters, the address height is 1, such as reading F17.xx: 0x11xx.

When the communication is abnormal, the slave response message will appear such as the following: (For the specific error code, see the meaning of the error code)

RTU Slave response message (when reading exception)	
Slave address	01H
Error flag	83H
Error Code	04H
CRC CHK low	40H
CRC CHK high	F3H
RTU slave response message (when write exception)	
Slave address	01H
Error flag	86H
Error Code	03H
CRC CHK low	02H
CRC CHK high	61H
RTU slave response message (when continuous write exception)	
Slave address	01H
Error flag	90H
Error Code	03H
CRC CHK low	0CH
CRC CHK high	01H

• **Error code meaning for a slave to respond to an abnormal message**

Error code	Meaning	Instructions
03	Wrong password	The user password written is different from the password set by the user
01	Read/write command error	Error in read/write command code
04	CRC check error	The CRC verification code is incorrect. Procedure
02	Function code invalid address	The read/write address does not belong to the scope of the read/write function code
03	Function code invalid parameter	The read and write parameters do not belong to the scope of function code parameters
04	Parameter change invalid	Running Status No Some parameters cannot be changed

Appendix II: CANopen communication protocol

- CAN data frame**

CAN Identifier+8 byte data

The device follows the Canopen2.0A protocol. The length of the identifier of the standard CAN is 11 bits

Each canopen frame starts with COB-ID. COB-ID is the unique identifier of the data frame

Each frame contains up to 8 bytes of data

COB_ID includes functional segments and address segments (Node-ID)

Node-ID is defined by system integrators and sets through functional code. The range of node-id is 1 ~ 127 (0 is not allowed to be used)

The smaller the COB_ID, the higher the priority of the message. Canopen's COB_ID range from 0-77F.

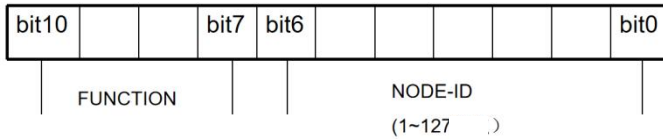

COB-ID		DLC	Data							
0	1		0	1	2	3	4	5	6	7
XX		8	XX	XX	XX	XX	XX	XX	XX	XX

- Command message and communication data description**

CANopen communication defines 4 communication messages:

1. Management packets, network management, and ID distribution services, such as initialization nodes, starting nodes, reset nodes, etc.; These services are based on the main communication mode of the main city. In the CAN network, there can be only one master node that sends management messages.
2. Preview packets or special function objects, such as nodes/life protection, BOOT-UP, emergency packets, synchronous messages, time marks
3. Service data object SDO (Service Data Objects), by using indexes and sub -indexes, SDO enables customers to access the item in the device (server) object dictionary
4. Process data object PDO (Process Data Objects), which is used to transmit real -time objects, data transmission is limited to 1 to 8 bytes

Manage Canopen communication status through NMT messages

COB-ID		Data							
0	1	0	1	2	3	4	5	6	7
000		CS	Node-ID						
000		01	01						
000		02	01						
000		82	01						

ID (000) indicates that the packet is an NMT management packet.

Data0: CS Indicates the command word. 0x01 indicates that the node is started to start PDO transmission. 0x02 indicates that the node is closed and PDO transmission is disabled. 0x80 indicates preoperation. 0x81 indicates that the node is reset. 0x82 indicates reset communication;

Data1: indicates the slave ID of the NMT packet management command. When Node-ID=0, all NMT slave devices are addressed

For the schematic diagram of packets supported by each node status, see:

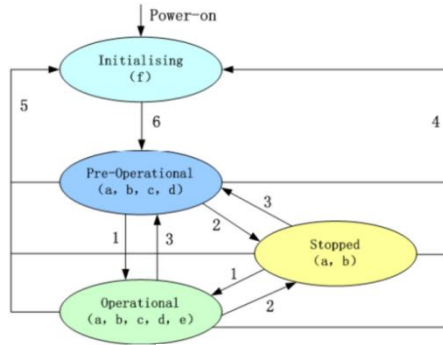

Node state transition diagram

Code	Meaning
a	NMT
b	Node Guard
c	SDO
d	Emergency
e	PDO
F	Boot-up

Configure (write) function codes through SDO messages

COB-ID		Data							
0	1	0	1	2	3	4	5	6	7
0x600+Node-ID		Send command word	Object Index		Object subindex	Maximum 4 bytes of data			
601		2B	01	20	03	02	00		

For example, F01.03 Run command channel is set to 2.

Including: ID (600+ slave station number) indicates the device operated by SDO, and slave station number is set by F14.21;

Data0: indicates the length of the object to be written. 2F indicates 1byte, 2B indicates 2byte, 27 indicates 3byte, and 23 indicates 4byte.

Data1 and Data2: indicates the index of the object to be written (primary index 2001). The high value of the primary index of the function code is always 20, and the low value 01 indicates the F01 group of function code.

Data3: indicates the written object sub index (subindex 03), which indicates the 03 object of function code F01 group, that is, F01.03.

Data4 and Data5:0200 represent the valid data 0002 of the object being written.

Note:

1. The high bits of the object index and data is stored in the low address, and the low bits is stored in the high address
2. The function code index of this series of inverter is 0x20 at the high bits and the function code group number at the low bits.
3. The read and write operation of the function code of this series inverter is 2byte data, otherwise it will judge and report an error.

Slave recover

COB-ID		Data							
0	1	0	1	2	3	4	5	6	7
0x580+Node-ID	Receive command word	Object Index		Object subindex		Maximum 4 bytes of data			
581	60	01	20	03		02	00	00	00

Successful response

- Data0:60 indicates success
- Data1 and Data2:01 20 Primary index (2001)
- Data3:03 Subindex
- Data4 to Data7:0200 represents data 0002.

Response fail

- Data0:80 indicates success
- Data1 and Data2:01 20 Primary index (2001)
- Data3:03 Subindex
- Data4 to Data7:The data is an SDO abort code error

Read the function code through the SDO message

COB-ID		Data							
0	1	0	1	2	3	4	5	6	7
0x600+Node-ID	Send command word	Object Index		Object subindex					
601	40	60	20	07					

- Read the function code D00.07 bus voltage;
- ID (600+ slave station number) indicates the device operated by SDO;
- Data0: indicates that the command word read during sending is 40.
- Data1 and Data2: indicates index (primary index 2060).
- Data3: indicates the sub index (sub-index 07) of the object to be written.
- Data4 to Data7: indicates invalid data.

Slave recover

COB-ID		Data							
0	1	0	1	2	3	4	5	6	7
0x580+Node-ID	Receive command word	Object Index		Object subindex		Maximum 4 bytes of data			
581	4B	60	20	07		02	16	00	00

Successful response

- Data0:4F indicates 1byte, 4B indicates 2byte, 47 indicates 3byte, and 43 indicates 4byte.
- Data1 and Data2: 60 20 primary index (2060)
- Data3:07 Subindex
- Data4 to Data7:02160000 indicates data 00 00 16 02=5634, that is 563.4V(Hex to DEC, one decimal).

Response fail

- Data0:80 indicates success
- Data1 and Data2: 60 20 primary index (2060)

Data3:07 subindex

Data4 to Data7:The data is an SDO abort code error

(SDO abort code error refer to the SDO abort code error meaning table for the slave to respond to an exception message)

Configure PDO

The KC200 has three groups of TPDO and RPDO,each group contains four mapping objects.The contents of TPDO1 and RPDO1 mapping objects cannot be configured. The remaining groups of PDO mapping groups can be configured based on the standard object dictionary index definition.

TPDO1 mapping object 1 is the running state of D00.13 inverter, and the mapping object 2 is D00.04 output frequency.

RPDO1 mapping object 1 is function code 0x7000 run control command word, mapping object 2 is function code 0x7010 communication settings (frequency, etc.).

TPDO2,TPDO3 and RPDO2,RPDO3 can be configured by function code parameters or corresponding index of object dictionary.

Note: After the function code is configured, the application needs to be reset through the NMT management message (command word 0x81 or 0x82).

The mapping object is configured using the object dictionary in the following format: Mapping object index address + mapping object sub-index address + data type:

The default TPDO2 mapping object 1 is the D00.00 primary setting frequency, mapping object 2 is the D00.07 bus voltage, and mapping object 3 is the D00.19All voltage. The default mapping object of TPDO3 is 0.

The default RPDO2 mapping object 1 is the F01.03 Run command channel, and mapping object 2 is the F01.04 main frequency given source channel. The default mapping object of RPDO3 is 0.

TPDO packet synchronous transmission

After the node is enabled through NMT packets, PDO transmission is started. TPDO packets are transmitted according to the transmission type.

The transmission type of the PDO synchronous transmission mode is 1-240. When the value of the TPDO2 transmission type settings is 3, the meaning indicates that the controller is sent 3 times, the synchronous packet can trigger the transmission data once,the value can be modified according to the actual situation.

Send synchronous message 3 times

COB-ID		Data							
0	1	0	1	2	3	4	5	6	7
080		Remote frame, no data content							

Slave recover

COB-ID		Data							
0	1	0	1	2	3	4	5	6	7
281		88	13	2B	16	26	02	00	00
0x280+Node-ID,corresponds to the TPDO2 group		Indicates the data content of TPDO2 mapping object 1		Indicates the data content of TPDO2 mapping object 2		Indicates the data content of TPDO2 mapping object 3		Indicates the data content of TPDO2 mapping object 4	

ID: 281 (280+ slave station number) means TPDO2;

Data0, Data1: corresponds to D00.00, 8813 indicates that the main setting frequency is 1388=50.00Hz;

Data2, Data3: corresponds to D00.07, 2B16 indicates bus voltage data 162B=567.5V;

Data4, Data5: corresponding to D00.19, 2602 indicates that AI1 voltage is 0226=5.50V;

The data content of the three mapping objects corresponding to the default Settings of the TPDO2 group

TPDO packet asynchronous transmission

When the TPDO2 event time is not zero (the initial default is 1000ms) and the transmission type is 254 or 255, TPDO2 sends data every 1000ms.

COB-ID		Data							
0	1	0	1	2	3	4	5	6	7
281		88	13	15	16	26	02	00	00
0x280+Node-ID, corresponds to the TPDO2 group		Indicates the data content of TPDO2 mapping object 1		Indicates the data content of TPDO2 mapping object 2		Indicates the data content of TPDO2 mapping object 3		Indicates the data content of TPDO2 mapping object 4	

ID: 281 (280+ slave station number) means TPDO2;

Data0, Data1: corresponds to D00.00, 8813 indicates that the main setting frequency is 1388=50.00Hz;

Data2, Data3: corresponds to D00.07, 1516 indicates bus voltage data 1615=565.3V;

Data4, Data5: corresponding to D00.19, 2602 indicates that AI1 voltage is 0226=5.50V;

The data is sent once at an interval of 1000ms

When the TPDO1 event time is zero, the disable time is 300ms (not zero), and the transmission type is 255, the minimum interval is 300ms when the data in the mapping group changes

Return data

COB-ID		Data							
0	1	0	1	2	3	4	5	6	7
181		01	00	88	13				
0x180+Node-ID, corresponds to the TPDO1 group		Indicates the data content of TPDO1 mapping object 1		Indicates the data content of TPDO1 mapping object 2					

ID: 181 (180+ slave station number) indicates TPDO1;

Data0, Data1: corresponds to D00.13, 0100 indicates the operating state of the inverter is 0001, that is the forward running;

Data2, Data3: corresponds to D00.04, 8813 indicates the output frequency data 1388=50.00Hz;

It is sent every time the data changes, with a minimum interval of 300ms.

When the TPDO1 event time is zero, the disable time is not zero, and the transmission type is 254, the slave sends TPDO1 data once for each frame of RPDO1 data received.

COB-ID		Data							
0	1	0	1	2	3	4	5	6	7
201		05	00	10	27				
0x200+Node-ID, corresponds to the RPDO1 group		Indicates the data content of RPDO1 mapping object 1		Indicates the data content of RPDO1 mapping object 2					

Send RPDO1 data once

ID: 201 (200+ slave station number) indicates RPDO1;

Data0, Data1: corresponding to 0x7000, 0500 indicates that the inverter running command is 0005, that is, slow down and stop;

Data2, Data3: corresponding to 0x7010, 1027 indicates that when the main frequency channel is communication, the given frequency data of communication is $2710 = 100.00\% * 50.00\text{Hz}(\text{maximum frequency}) = 50.00\text{Hz}$;

Slave send

COB-ID		Data							
0	1	0	1	2	3	4	5	6	7
181		41	00	F5	12				
0x180+Node-ID, corresponds to the TPDO1 group		Indicates the data content of TPDO1 mapping object 1		Indicates the data content of TPDO1 mapping object 2					

ID: 181 (180+ slave station number) indicates TPDO1;

Data0, Data1: corresponds to D00.13, 4100 indicates that the operating state of the inverter is 0041, that is, 0100 0001, and it is in positive and decelerating operation;

Data2, Data3: corresponds to D00.04, F512 indicates the current instantaneous output frequency data $12F5 = 48.53\text{Hz}$;

Each time RPDO1 sends data, the slave sends TPDO1 data

RPDO message transmission

COB-ID		Data							
0	1	0	1	2	3	4	5	6	7
301		02	00	05	00				
0x300+Node-ID, corresponds to the RPDO2 group		Indicates the data content of RPDO2 mapping object 1		Indicates the data content of RPDO2 mapping object 2		Indicates the data content of RPDO2 mapping object 3		Indicates the data content of RPDO2 mapping object 4	

Send RPDO2 packet

ID: 301 (300+ slave station number) indicates RPDO2;

Data0, Data1: corresponds to F01.03. 0200 indicates that the command channel is 0002, that is, the communication command channel.

Data2, Data3: corresponding to F01.04, 0500 indicates that the given source channel of the main frequency is 0005, that is, the given main frequency of communication;

Note: The type of transmission of RPDO does not distinguish between synchronization and asynchronous. When the data is sent, it can be received.

Supervisory protection message

During operation, the master station detects the status of the slave station by any monitoring method

Heartbeat message

The slave station periodically sends heartbeat packets to the master station according to Heartbeat Packet Generation Time. If the master station does not receive the next heartbeat packet from the slave station after a certain period of time (set in the master station), the master station determines that the slave station is faulty.

Message format -- (0x700+ node number) + status

Status - 0: start, 4: Stop, 5: Run, 127: preoperation

COB-ID		Data							
0	1	0	1	2	3	4	5	6	7
0x700+Node-ID		State							
701		7F							

ID: 701 (700+ slave station ID) indicates the monitor packet.

Data0:7F indicates the pre-operation state of 127.

The default heartbeat interval is 10000ms.

Node Protection

The master station periodically sends the message to the slave station with the "supervision time". If the slave station has not received the node message sent by the master station after the "supervision time * life factor" time, then the slave station alarms!

Master request message format -- (0x700+ node number) (the message has no data)

Slave response message format -- (0x700+ node number) + Status:

Status - The data section includes a trigger bit (bit7), which must be alternately set to "0" or "1" in each node protection response.

The trigger bit is set to 0 for the first node protection request. Bit 0 in place 6 (bit0~6) indicates the node status.

0: initialization; 1: not connected; 2: connection; 3: Operation; 4: Stop; 5: Run; 127: pre-operation.

When the heartbeat time is zero, a remote frame is sent

COB-ID		Data							
0	1	0	1	2	3	4	5	6	7
701		Remote frame, no Data data							

Alternate response from slave

COB-ID		Data							
0	1	0	1	2	3	4	5	6	7
701		05							

COB-ID		Data							
0	1	0	1	2	3	4	5	6	7
701		85							

ID: 701 (700+ slave station ID) indicates the monitor packet.

Data0:05 indicates 0101. The trigger position 0,05 is running. 85 indicates 1000 0101, triggering position 1,05 Running status

The default value of the monitoring time is 1000ms. The default value of the life factor is 3, that is, the default value of the power saving protection monitoring time is 3000ms.

Urgent message

When a fatal error occurs inside the device, it is sent to other devices with the highest priority. Error alarm signal for interrupt type. An emergency message contains eight bytes. The format of the message is as follows:

COB-ID	Data
--------	------

0	1	0	1	2	3	4	5	6	7
081		00	81	04	1D				
0x080+Node-ID		Emergency error code		Error register (object 0x1001)	KC200 specified fault code				

ID: 080 indicates an urgent packet.

Data0-Data1:0081 indicates a communication error with error code 8100.

Data2:04 Indicates error type Communication error.

Data3:1D indicates E0029, indicating fault code 029, indicating a communication timeout fault

Error types and error codes refer to the standard CANopen protocol, and fault codes refer to the KC200 fault code table

Communication control parameter group address description

The high of the main index of the communication control parameter is the same as the high of the main index of the function code, which is always 0x20. The low level of the primary index and the low level of the sub-index correspond to the high level and low level of the communication address respectively

Function description	Address	Data meaning declaration	R/W
Communication given master frequency	0x7010 (F01.04=5)	0 ~ 10000 corresponds to the maximum frequency of 0.00% ~ 100.00% (F01.11)	W
Communication given auxiliary frequency	0x7010 (F01.05=5)	0 ~ 10000 corresponds to the maximum frequency of 0.00% ~ 100.00% (F01.11)	W
Communication command setting	0x7000	0x0000: No command 0x0001: Forward run 0x0002: Reverse run 0x0003:FJOG 0x0004: RJOG 0x0005: deceleration and shutdown 0x0006: emergency shutdown 0x0007: Free stop 0x0008: Fault reset	W
Communication write terminal	0x70XX	The lowest address is: 01: Write A01 02: Write A02 03: Write D0 04: Write pulse output	W
Inverter fault code	0x6F00	Inverter current fault code (see fault code table)	R
Communication given upper limit frequency	0x7010 (F01.12=5)	0 ~ 10000 corresponds to the maximum frequency of 0.00% ~ 100.00% (F01.11)	W
VF separation voltage settings	0x7010 (F05.20=5)	0 to 10000 corresponds to 0.00% to 100.00% of the rated voltage	W
Maximum torque source under speed control (electric)	0x7010 (F06.11=5)	0 ~ 10000 corresponds to the upper limit of 0.00% ~ 100.00% (F06.12)	W
Maximum torque source under speed control (power generation)	0x7010 (F06.13=5)	0 ~ 10000 corresponds to the upper limit of 0.00% ~ 100.00% (F06.14)	W
Communication given PID setting value	0x7010 (F16.00=5)	The value from 0 to 10000 corresponds to 0.00% to 100.00%	W
Communication given PID feedback value	0x7010 (F16.03=4)	The value from 0 to 10000 corresponds to 0.00% to 100.00%	W
Multi-speed instruction 0 frequency setting	0x7010 (F17.00=5)	0 ~ 10000 corresponds to the maximum frequency of 0.00% ~ 100.00% (F01.11)	W
Fault status reading	0x61XX	Inverter fault status (save up to five faults) (see fault code table)	R

Input terminal state	0x6010/0x6013/0x6015/ 0x6017/0x6019	0x6010: DI terminal input status 0x6013: AI1 Terminal input status 0x6015: AI2 Terminal input status 0x6017: AI3 Terminal input status 0x6019: Keyboard potentiometer input status	R
Output terminal state	0x6011/0x601A/0x601B	0x6011: DO terminal output status 0x601A: AO1 terminal output status 0x601B: AO2 terminal output status (0-1000 corresponds to output 0V ~ 10V, 0mA ~ 20mA)	R

Note: For other function code addresses, see the "Address" column in the function code table.

When the F00 to F15 parameter group parameters are written using the write command, if the address field height of the function code parameter is 8, the parameters are written only into the RAM of the inverter and are not stored after power failure. If the upper half byte of the address field of the function code parameter is 0, the parameter is written to the EEPROM.

For example, parameters F00.xx: 0x80xx (write to RAM), 0x00xx (save to EEPROM); Parameter F01.xx: 0x81xx (write to RAM) 0x01xx (save to EEPROM), and so on for other parameter groups. When the F00 to F15 parameter group parameters are read, the upper half byte of the address is 0, for example, F03.xx: 0x03xx.

When the F16 to F17 parameter group parameters are written using the write command, if the address field height of the function code parameter is 9, it is only written into the RAM of the inverter and is not stored after power failure. If the address field height of the function code parameter is 1, the parameter is written into the EEPROM.

For example, parameter F16.xx: 0x90xx (write to RAM) 0x10xx (save to EEPROM); Parameter F17.xx: 0x91xx (write to RAM) 0x11xx (save to EEPROM), and so on for other parameter groups. When the F16 to F17 parameter groups are read, the upper half byte is 1, for example, F17.xx: 0x11xx.

SDO abort code error meaning for the slave to respond to an exception message

Error code	Meaning	Description
0x05040001	Client/server command specifiers are invalid or unknown	The command instruction entered by SDO is invalid
0x06010000	The object is not accessible	The access function code parameter is invalid
0x06010002	Trying to write a read-only object	Invalid read-only object or function code parameter change for write object dictionary
0x06010001	Attempts to read only write objects	The read object dictionary only writes objects
0x06020000	The object does not exist in the object dictionary	The read/write index does not belong to the object dictionary object parameter
0x06070010	The data type does not match	Write function code data exceeds the limit
0x06090011	Object dictionary neutron index does not exist	Access object dictionary Object subindex exceeds the limit
0x80000000	General failure	Write function code non-two-byte data or other generic errors
0x08000020	Data cannot be transferred or saved to the application	Read object dictionary data type is incorrect