

PROVEN PERFORMANCE

Customers in over 60 countries and in diverse markets and sectors.

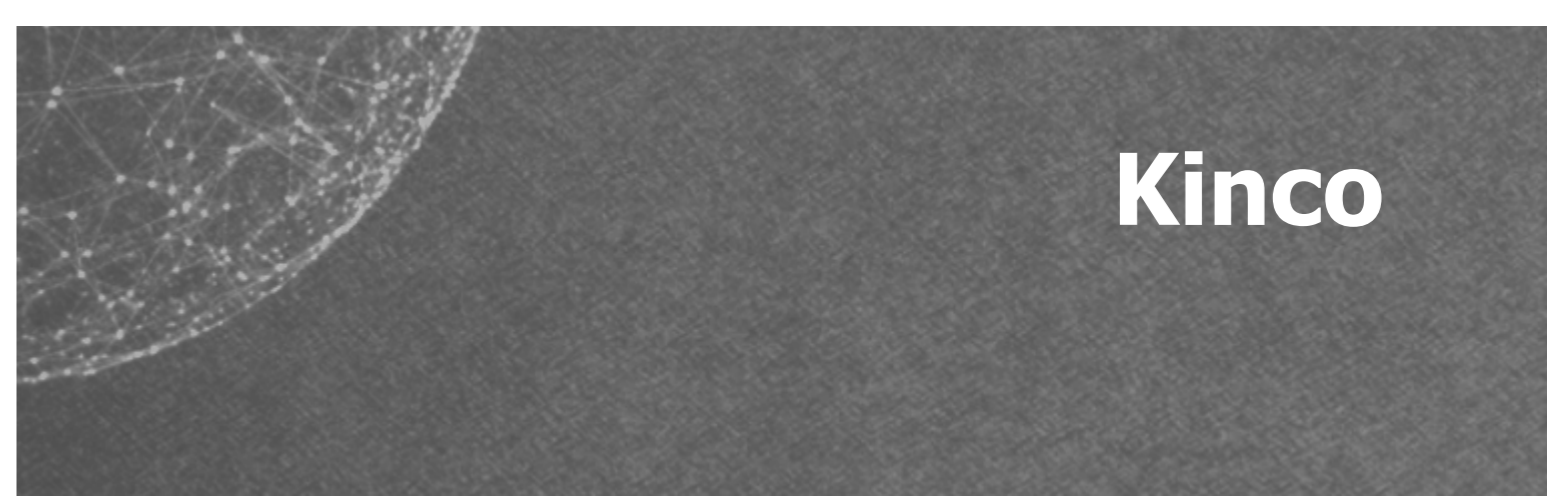

Motion
Control
Servo System

➔ **Low-voltage
Servo System Catalog**

- FD1X5 Servo Drive
- iSMK drive and motor integrated machine
- SMK low voltage servo motor



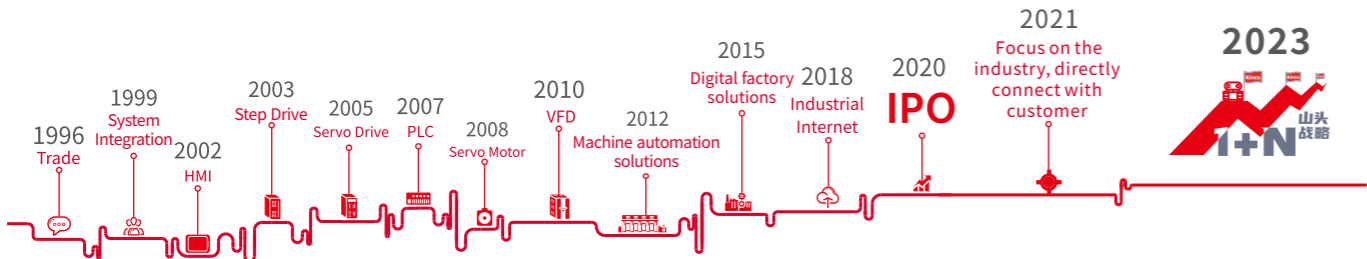

Shanghai Kinco Automation Co., Ltd. focuses on R&D, production, sales and technical services of automation standard products and intelligent hardware products, which is a leading supplier of machine automation and intelligent solutions for factories in China.

In 1996, Kinco has been providing total automation solutions for global industrial automation equipment manufacturers by relying on standard automation products such as HMI, servo system, stepping system, PLC, low-voltage inverter, etc. to penetrate into the industry, making China's automation solutions prevail all over the world. The company's HMI products have led the wave of HMI popularization in China, and its market share has maintained a leading position among local brand manufacturers for many years.

With the mission of "Making China's manufacturing become the top manufacturing in the world", Kinco company insists on investing a large amount of resources in the research and development of automated technology platforms, and sets up R&D facilities in Shanghai, Shenzhen and Changzhou. Kinco company has an automated technology platform that covers all aspects of control, drive, human-machine interaction, communication and electromechanical integration design. In the field of machine automation, Kinco focuses on the industry and has developed special solutions for logistics automation, service robots, medical instruments, professional drones, 3C machine tools, ozone and other industries.

In the field of smart factory, Kinco provides customers with the most easy-to-implement smart factory solutions for manufacturing companies at the field implementation level, PLC control and communication level, Scada and system integration level, and MES management level through its comprehensive automation technology platform and software system developed for smart factory.

With the vision of "creating a better life intelligently" and adhering to the values of "maintain conscience in growth and hold ingenuity in innovation", Kinco is a platform to help employees maximize their creative potential and a partner to help customers succeed in innovative management. We develop products and operate businesses with innovative thinking and practical spirit, adhere to ideals, and expect human creativity to make the world more wonderful.

FD1X5 series

New design platform, high-performance low-voltage fifth generation servo driver

FD1X5

New design platform

NEW



- ✓ Compatible with both RS485 and CANopen communication;
- ✓ Automatically identify motor parameters;
- ✓ Motor temperature monitoring and over temperature protection;
- ✓ Equipped with S-curve and parameter self-tuning function;
- ✓ Motor overspeed protection;
- ✓ Use Type-C debugging port.

Drive naming rule

Model: **FD 1 2 5 - AB - 000**

① ② ③ ④ ⑤ ⑥

①-Series Name	FD: FD series	④-Drive version	5: Fifth generation low-voltage drive
②-Upply voltage	1: Input Voltage DC24~60V	⑤ -Control mode	AB: RS485, CANopen, Have pulse, 24V logic power supply
③-Drive current	2: 15Arms 3: 30Arms 4: 50Arms	⑥Software Version	000: Software Version Number

Note : The output currents for the FD125, FD135 and FD145 are 15Arms, 30Arms and 50Arms respectively. These values were measured with the driver mounted on a 300mm*300mm*10mm (L*W*H) black oxide 6063 aluminum plate auxiliary heatsink.

FD1X5 Servo driver configuration table

Rated power/ Rated current	Servo motor	Description	Power cable Brake cable	Encoder cable	Servo Drive		
					CANopen+RS485 Pulse		
200W/5.7A	SMK60S-0020-30SAK-5DSA	Singleturn communication type magnetolectric encoder motor	MOT-005-LL-KA-D	ENCHG-LL-GA	FD125-AB-000		
	SMK60S-0020-30SBK-5DSA	Singleturn communication type magnetolectric encoder brake motor	MOT-005-LL-KAB-D				
400W/10.6A	SMK60S-0040-30SAK-5DSA	Singleturn communication type magnetolectric encoder motor	MOT-011-LL-KA-D				
	SMK60S-0040-30SBK-5DSA	Singleturn communication type magnetolectric encoder brake motor	MOT-011-LL-KAB-D				
750W/19.9A	SMK80S-0075-30SAK-5DKA	Singleturn communication type magnetolectric encoder motor	MOT-020-LL-KA-D			FD135-AB-000	
	SMK80S-0075-30SBK-5DKA	Singleturn communication type magnetolectric encoder brake motor	MOT-020-LL-KAB-D				
1000W/26.4A	SMK80S-0100-30SAK-5DKA	Singleturn communication type magnetolectric encoder motor	MOT-030-LL-KA-D				
	SMK80S-0100-30SBK-5DKA	Singleturn communication type magnetolectric encoder brake motor	MOT-030-LL-KAB-D				
200W/5.7A	SMK60S-0020-30QAK-5DSA	Multiturn communication type magnetolectric absolute value encoder motor	MOT-005-LL-KA-D		ENC DG-LL-GA/ ★ENCHG-(4)-GU-DC		FD125-AB-000
	SMK60S-0020-30QBK-5DSA	Multiturn communication type magnetolectric absolute value encoder holding motor	MOT-005-LL-KAB-D				
400W/10.6A	SMK60S-0040-30QAK-5DSA	Multiturn communication type magnetolectric absolute value encoder motor	MOT-011-LL-KA-D				
	SMK60S-0040-30QBK-5DSA	Multiturn communication type magnetolectric absolute value encoder holding motor	MOT-011-LL-KAB-D				
750W/19.9A	SMK80S-0075-30QAK-5DKA	Multiturn communication type magnetolectric absolute value encoder motor	MOT-020-LL-KA-D	FD135-AB-000			
	SMK80S-0075-30QBK-5DKA	Multiturn communication type magnetolectric absolute value encoder holding motor	MOT-020-LL-KAB-D				
1000W/26.4A	SMK80S-0100-30QAK-5DKA	Multiturn communication type magnetolectric absolute value encoder motor	MOT-030-LL-KA-D				
	SMK80S-0100-30QBK-5DKA	Multiturn communication type magnetolectric absolute value encoder holding motor	MOT-030-LL-KAB-D				

Note:1. "LL" in the power line/brake line/encoder line list indicates the cable length, please refer to the model description.
2. ★ENCHG - (4) - GU-DC is an essential battery power cable for multi turn absolute encoder motors, with a length of 40CM.
3. SMK80S-0100-30□■K-5DKA is recommended to match FD135, If 3 times overload is required, it needs to be matched with FD145.

FD1X5 servo driver technical parameters table



Model parameter		FD1X5 servo driver		
		FD125-AB-000	FD135-AB-000	FD145-AB-000
Rated input voltage	Power	24VDC~60VDC		
	Logic power	24VDC 1A (Can not connect)		
Rated output current	Maximum continuous output current (rms)	15A (Up to 12A without auxiliary cooling plate)	30A (Up to 22A without auxiliary cooling plate)	50A (Up to 35A without auxiliary cooling plate)
	Peak current (AP)	48A	100A	160A
Feedback signal		Tamagawa protocol single-turn, multi-turn encoder		
Energy consumption brake		Need external brake resistance (depending on the operation condition, mainly used in rapid start-stop occasions)		
Energy consumption brake voltage absorption point		The default is 63V, which can be set by software		
Overvoltage alarm voltage		The default is 70V, which can be set by software		
Undervoltage alarm voltage		The default is 18V, which can be set by software		
Cooling mode		Natural cooling		
Weight (kg)		0.322	0.657	0.861
Logic loss power (mW)		1000	1200	1300
General function	General function	3 channels digital input, COM1 terminal; High level: 12.5-30VDC; Low level: 0-5VDC; Maximum frequency: 1KHz; Input impedance: 5KΩ.		
	Input function	Freely defined as required, the functions are as follows: drive enable, drive error reset, drive mode control, speed loop proportional control, positive limit, negative limit, origin signal, command reverse, internal speed segment control, internal position segment control, emergency stop, start to find the origin, command activation, electronic gear ratio switching, gain switching		
	Pulse control	Pulse+direction, phase A+phase B (3.3V~24V)		
	Output specification	1 digital output, OUT1 is an open collector output, up to 30V, 100mA drive capability, The brake is PWM output, the effective voltage value is 24V, (BR+/BR-) capacity is 1A, no external power supply is required, and the brake device can be directly driven		
	Output function	following functions can be freely defined as needed, with the following functions: drive ready, drive error, motor position reached, motor zero speed, motor holding brake, motor speed reached, index Z signal present, maximum limit speed in torque mode, motor locked axis, motor in limit, home position found.		
	Type-C	Debug special, can use Kinco PC software connection		
	Protect function	Overvoltage protection, undervoltage protection, motor overheat (I2T) protection, short circuit protection, drive overheat protection		
Bus function	Modbus/RS485	It supports a maximum 115.2K baud rate and can communicate with the controller using Modbus RTU		
	CANopen	It supports a maximum of 1 M baud rate and can communicate with the controller using the CANopen		
Installation site		Dust-free, dry, lockable (e.g. electrical cabinet)		
Installation method		Install vertically or horizontally		
Application environment	Working Temperature	-20°C~40°C (no freezing) ,When the operating temperature exceeds 40°C, the driver needs to be derated		
	Storage temperature	-40°C~70°C (no freezing)		
	Humidity (no condensation)	Less than 90%RH		
	Protection class	IP20		
	Altitude	The rated working altitude is less than 1000 meters above sea level. When the working altitude is higher than 1000 meters, it is necessary to reduce the rated value by 1.5% for every 100 meters of elevation. The maximum working altitude is 4000 meters above sea level.		
	Atmospheric pressure	86kpa~106kpa		

FD125 mechanical dimension drawing

Note: wiring is needed around the driver, so it is recommended to keep a space of > 80 mm.

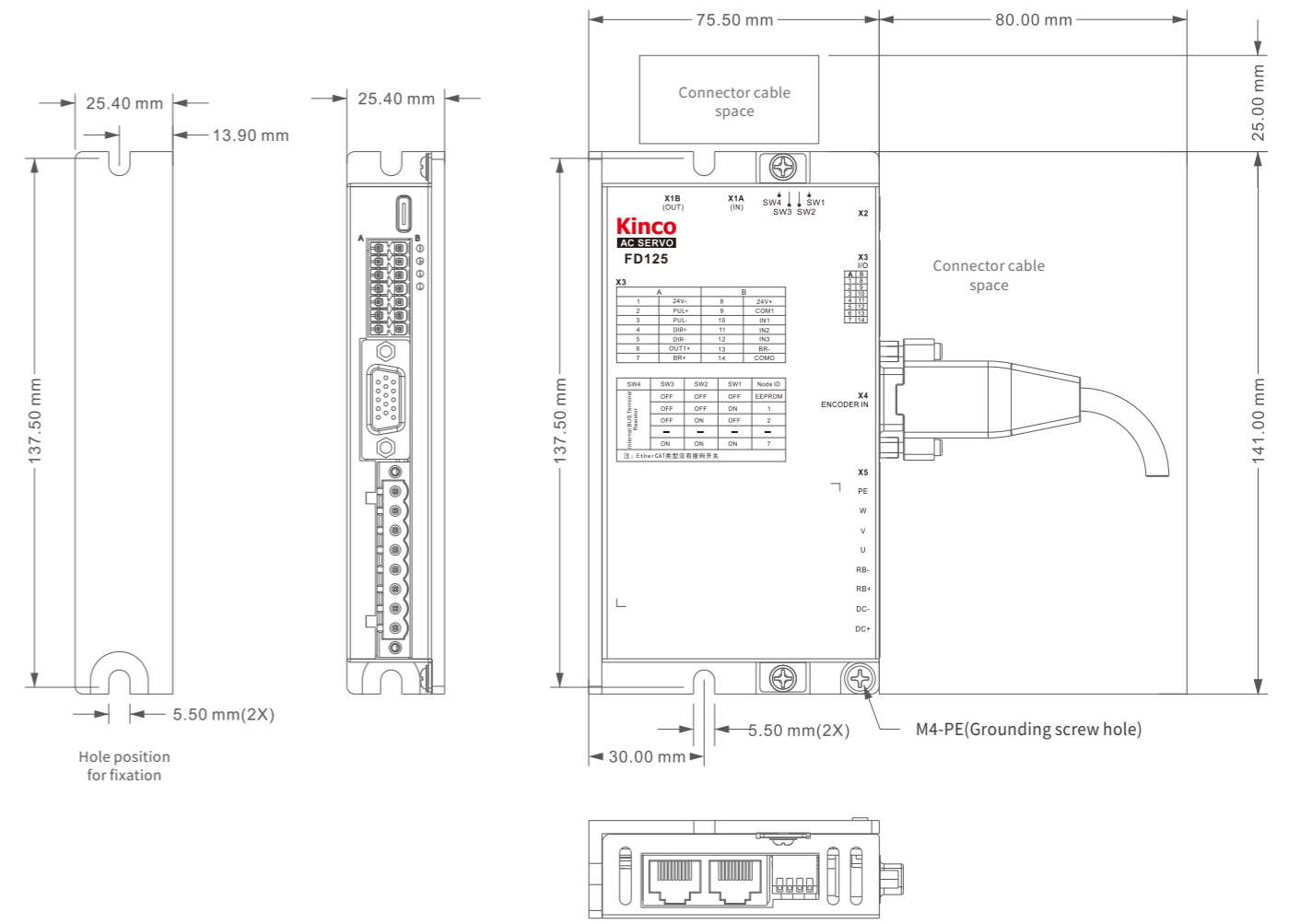

FD135 mechanical dimension drawing

Note: wiring is needed around the driver, so it is recommended to keep a space of > 80 mm.

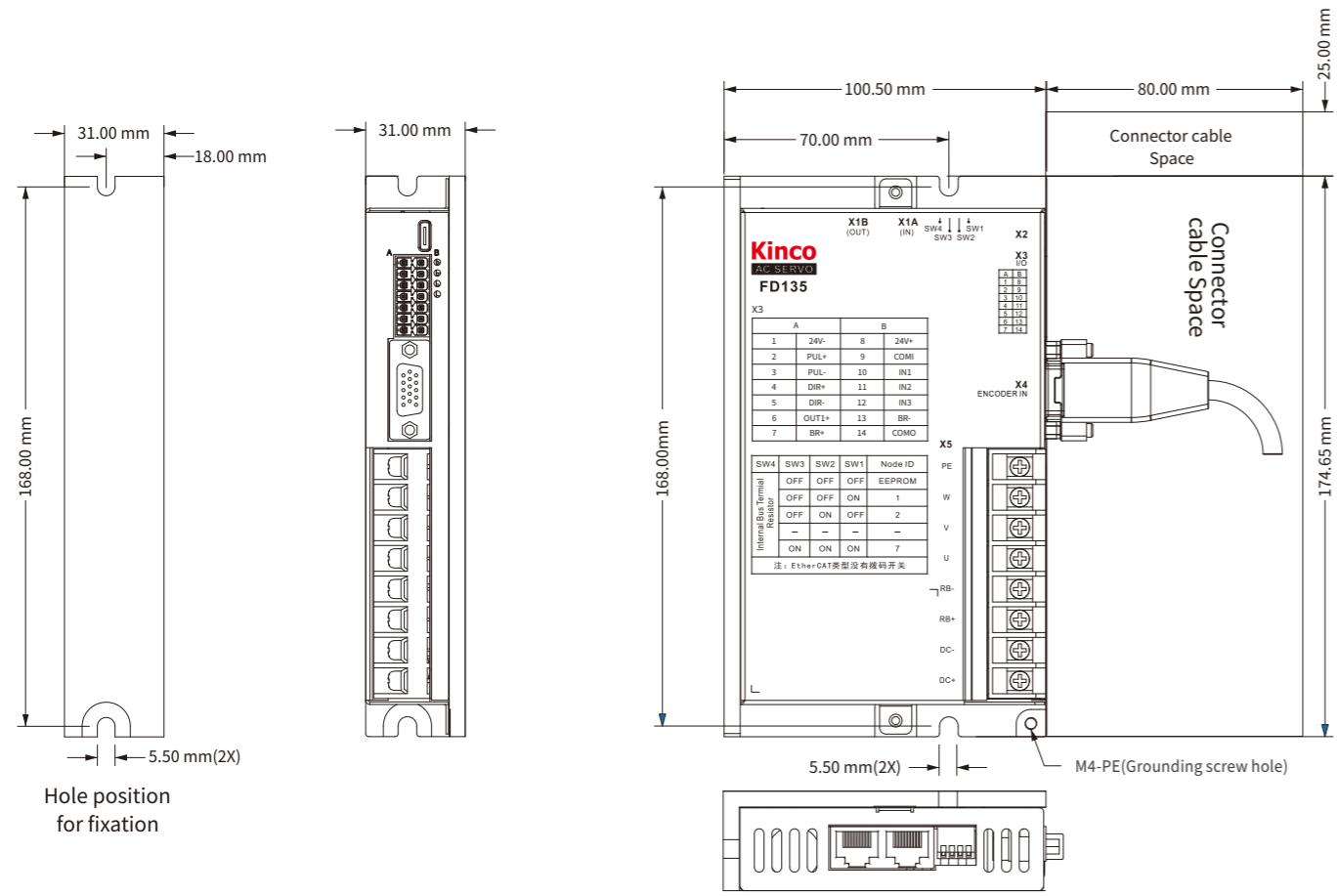

FD145 mechanical dimension drawing

Note: wiring is needed around the driver, so it is recommended to keep a space of > 80 mm.

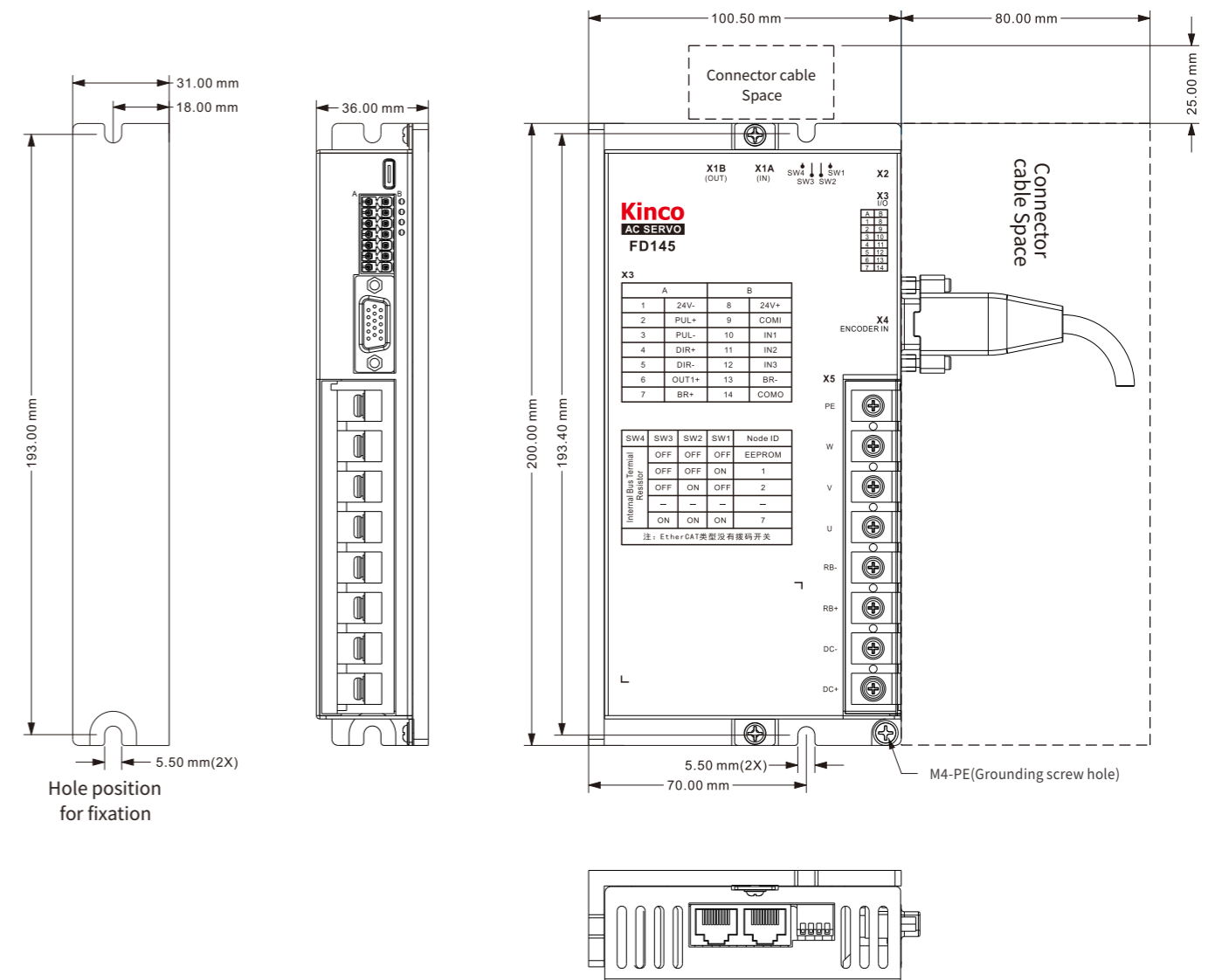

FD1X5 servo driver wiring port description

Bus communication interface X1

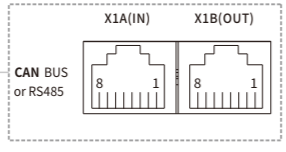

Pin No.	RS485/Modbus	CAN
1	\	CAN_H
2	\	CAN_L
3	\	GND_CAN
4	485B	\
5	485A	\
6	\	\
7	\	\
8	GND_RS485 (reserve)	+5V_CAN (reserve)

USB communication interface X2

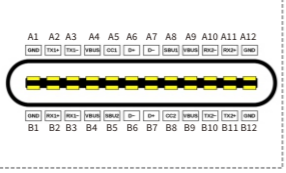

Pin No.	Signal
A1&B12	GND
A6&B6	USBDP
A7&B7	USBDN
A4&B9	+5V

Digital signal input/output port X3

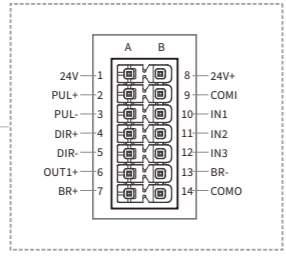

Pin No.	Signal	Pin specification
8	24V+	The logical power input is positive Input voltage: 24V, rated input current: 1A
1	24V-	The logical power input is negative Input voltage: 24V, rated input current: 1A
2	PUL+	Input voltage: 3.3V~24V, Maximum input frequency: 500KHz
3	PUL-	
4	DIR+	
5	DIR-	
6	OUT1+	
14	COMO	Output common terminal
7	BR+	Lock gate output positive end The output current of the lock port is 500mA
13	BR-	Lock output negative end The output current of the lock port is 500mA
9	COMI	Input common terminal
10	IN1	Digital signal input
11	IN2	High level: 12.5-30VDC; Low level: 0-5VDC;
12	IN3	Maximum frequency: 1KHz; Input impedance: 5KΩ.

Encoder input X4

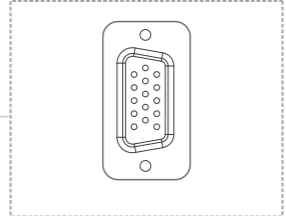

Pin No.	Magnetolectric photoelectric encoder signal(Supporting the Tamagawa Agreement)
1	+5V
2	GND
3	PTC_IN (Motor temperature detection)
4	\
5	\
6	\
7	\
8	\
9	ENC_A
10	\
11	\
12	\
13	\
14	ENC_B
15	\

Power and Motor Ports X5

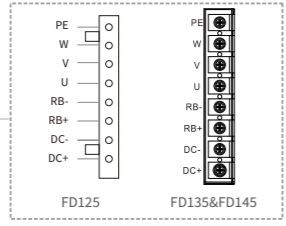

Pin No.	Signal
1	PE
2	W
3	V
4	U
5	RB-
6	RB+
7	DC-
8	DC+

FD1X5 servo drive electrical and communication wiring

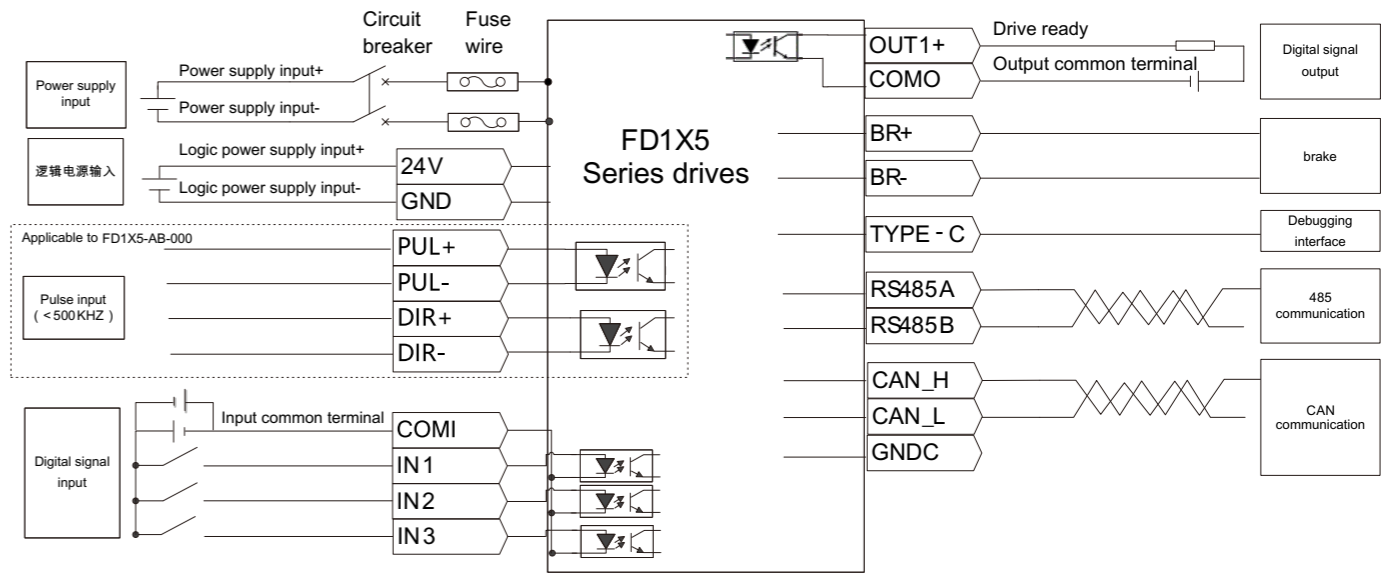

iSMK drive and motor integrated machine

Product features:

Compact body, highly integrated motor, driver, encoder and brake in one;

Support 24 ~ 60VDC wide voltage.

Supports CANopen, Modbus RTU, etc.

A variety of safety protection measures such as overvoltage protection, under pressure protection, short-circuit protection, motor overheating (IIT) protection, and driver overheating protection;

Can be equipped with a standard reducer, suitable for rotary jacking and other scenes.



iSMK naming rules

型号: iSMK60-040-DMAK-AA-000

① ② ③ ④ ⑤ ⑥ ⑦ ⑧ ⑨

①-Series name	iSMK: iSMK Integrated servo motor	⑥-Brake	A: Without brake B: With brake
②-Flange	60: 60x60(mm) 80: 80x80(mm)	⑦-Output axis style	K: With key
③-Rated power	020: 20x10(W) 075: 75x10(W) 040: 40x10(W)	⑧-Contro mode	AA: RS485, CANopen, Not pulse, 24V logic power supply
④-Supply voltage	D: Input Voltage DC24~60V	⑨-Software version number	000: Software version number
⑤-Encoder type	M: Singleturn communication type magnetolectric encoder		

Note: The oil seal is an optional accessory, and it can be omitted if it is not necessary.

iSMK integrated servo drive motor technical parameters

Model parameter		iSMK drive and motorintegrated machine		
		iSMK60-020-DM■K-AA-000	iSMK60-040-DM■K-AA-000	iSMK80-075-DM■K-AA-000
Input	power	24VDC~60VDC	24VDC~60VDC	24VDC~60VDC
	Built-in fuse	Null	Null	Null
	Logic power	24V	24V	24V
Rated power Pn(W)		200	400	750
Rated speed nN(rpm)		3000	3000	3000
Rated torque Ts(Nm)		0.64	1.27	2.39
Maximum torque Tm(Nm)		1.92	3.81	7.17
Weight (Kg)		1.1	0.31	0.85
		1.6 (With brake) (With brake)	0.314 (带抱闸)	0.91 (With brake)
Rotational inertia Jm(Kg·cm ²)		0.17	900	900
		0.176 (With brake)		
Logic loss power (mW)		900		
Energy consumption brake		There is no brake circuit inside the driver, and an external brake module is required		
Overvoltage alarm voltage		The default is 70V, which can be set by software		
Undervoltage alarm voltage		The default is 18V, which can be set by software		
Cooling mode		Natural cooling		
General function	Input specification	Two digital inputs, high: 12.5VDC ~ 30VDC Low: 0VDC ~ 5VDC Input impedance: 5KΩ Input frequency: <1KHz		
	Input function	Freely defined as required, the functions are as follows: drive enable, drive error reset, drive mode control, speed loop proportional control, positive limit, negative limit, origin signal, command reverse, internal speed segment control, internal position segment control, emergency stop, start to find the origin, command activation, electronic gear ratio switching, gain switching		
	Output specification	1 digital output, OUT1 for the open collector output, the highest voltage 30V, driving capacity of 100mA		
	Output function	Freely defined according to needs, the functions are as follows: driver ready, driver error, motor position to, motor zero speed, motor lock brake, motor speed to, index Z signal appears, maximum limit speed in torque mode, motor lock shaft, motor limit medium, origin finding		
Bus function	Protection function	Overvoltage protection, undervoltage protection, motor overheat (I2T) protection, short circuit protection, driver overheat protection		
	RS485	It supports a maximum 115.2Kbps baud rate and can communicate with the controller using the Modbus RTU		
Apply environment	CANopen	It supports a maximum 1Mbps baud rate and can communicate with the controller using the CANopen		
	Operation temperature	-20°C~40°C (no freezing) ,When the operating temperature exceeds 40°C, the driver needs to be derated		
	Operating humidity	Less than 90%RH (no condensation)		
	Storage temperature	-40°C~70°C (no freezing)		
	Storage humidity	90%RH (no condensation)		
	Installation method	Motor flange installation (vertical side installation)		
	Protection grade	IP65, shaft end IP54		
Altitude	The rated working altitude is less than 1000 meters above sea level. When the working altitude is higher than 1000 meters, it is necessary to reduce the rated value by 1.5% for every 100 meters of elevation. The maximum working altitude is 4000 meters above sea level.			
Atmospheric pressure	86kpa~106kpa			

Note: ■=A: Without brake
B: With brake (Power supply conversion, external unlocking.)

iSMK integrated servo drive motor mechanical dimensions

iSMK60 series mechanical dimension diagram (unit: mm)

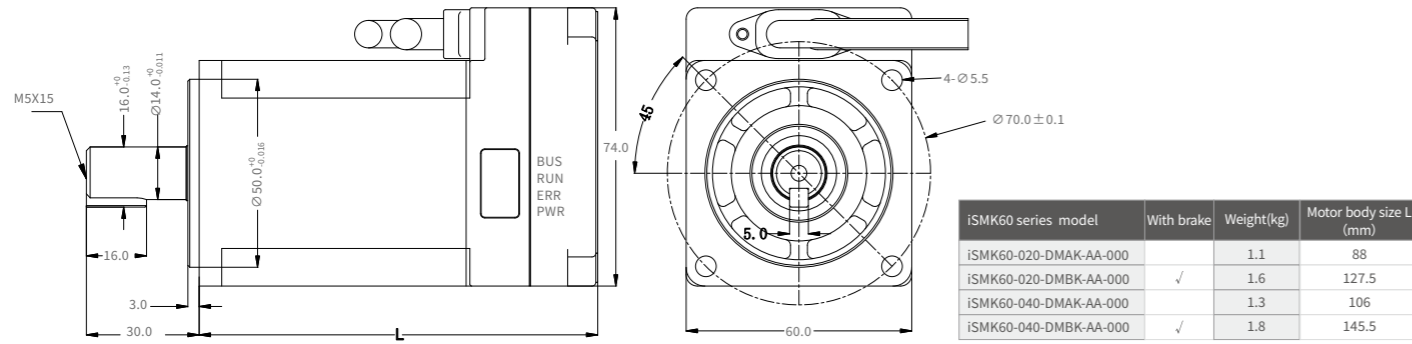

iSMK80 series mechanical dimension diagram (unit: mm)

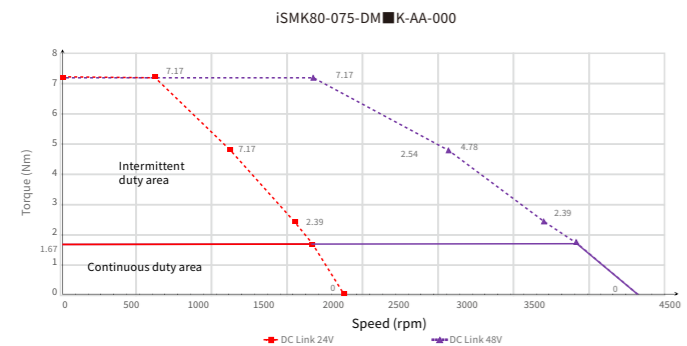
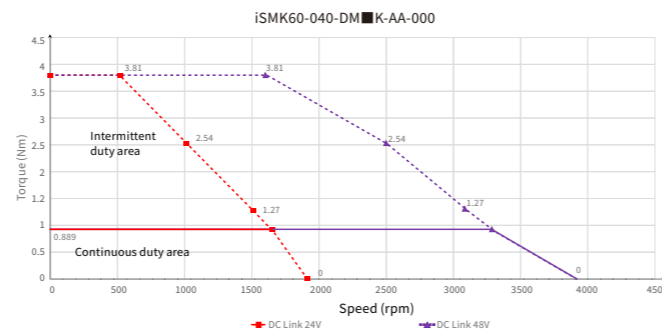
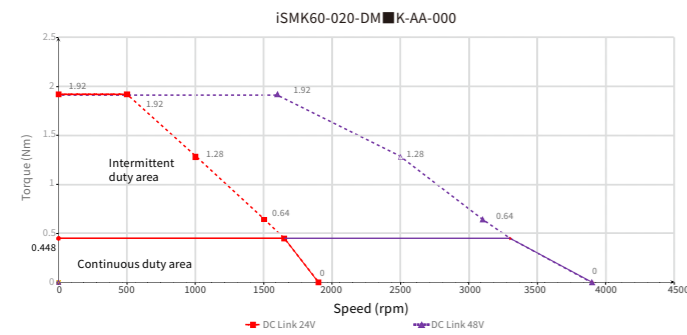
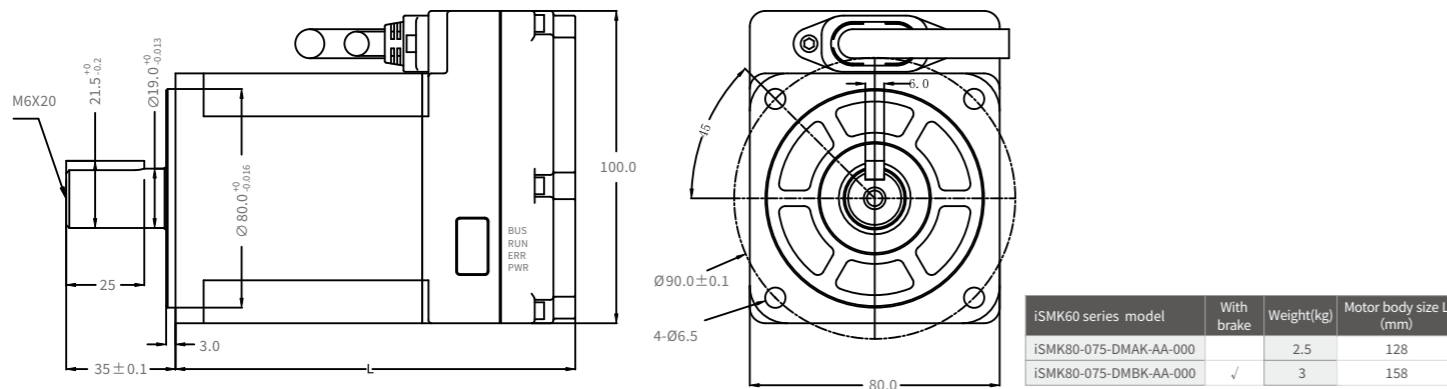

iSMK integrated servo drive motor connection port description

Communication cable terminal definition

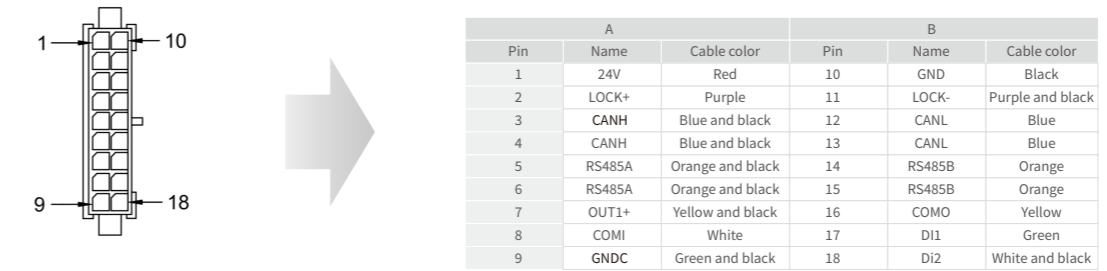

Note: This definition applies to iSMK60 & 80 AA. External wiring of ISMK AA can be purchased.

Wiring Diagram of Recommended Circuit for Forced Unlocking Brake

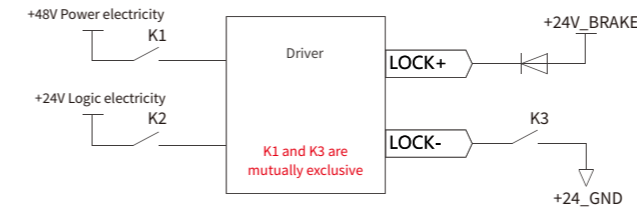

Note: After cutting off the iSMK logic and power supply, use the power supply

Signal	Function description
24V	The logic power supply is an optional option. When using the logic power supply, ensure that the power supply and logic are completely isolated. If the system power supply is not isolated, the logical ground cable is not connected. The logic power supply is connected at DC- and 24V
GND_IN	Logic electrical reference ground
LOCK+	External release beake input The input voltage is 24V, the maximum input current is 0.7A, only when the AGV body battery is out of emergency use;
LOCK-	Only when both the logic power supply and the power supply are powered off, the external lock can be unlocked. Do not short-circuit or connect to other signals and enclosures during normal operation
CANH	CAN signal positive end
CANL	CAN signal negative end
485A	RS485 data positive end
485B	RS485 data negative end
GND_C	Signal ground
DIN1	Digital signal input; High level: 12.5VDC~30VDC Low level: 0VDC~5VDC Input impedance: 5KΩ Input frequency: <1KHz
COMI	Digital signal input to the common end
OUT1+	Digital signal output; 1 digital output, maximum output current: 100mA
COMO	Digital signal output common terminal

Power cable port definition

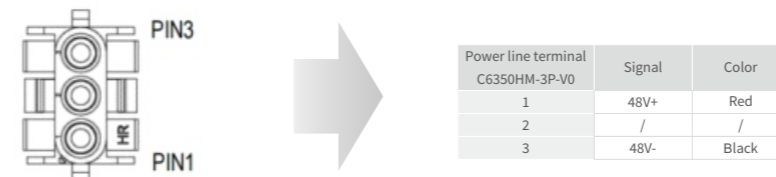

SMK series common body low-voltage servo motor

Product features:

New electromagnetic design

Adopting 12-slot and 10-pole design, with small slot torque and low torque pulsation, which is conducive to reducing the vibration during the operation of the motor and making the torque output more smooth.

New structure and short fuselage

The redesign of the fuselage structure shortens the length of the fuselage, which can save more installation space and reduce the size of the equipment for customers' equipment.

Insulation class F

The motor in the industry is at the highest insulation level, which can maintain high reliability and stability in high temperature extreme environment.

Energy efficiency class: 2



SMK series naming rules

Model: **SMK60S-0040-30SAK-5DSA**

① ② ③ ④ ⑤ ⑥ ⑦ ⑧ ⑨ ⑩ ⑪ ⑫

①-Series name	SMK: Common body series	⑦-Brake	A: Without brake B: With brake
②-Flange	60: 60x60(mm) 80: 80x80(mm)	⑧-Output axis style	K: Withkey
③-Inertia type	S: Small inertia	⑨-Number of polar pairs	5: 5-pole pair
④-Rated power	0020: 10x20(W) 0040: 10x40(W) 0075: 10x75(W) 0100: 10*100 (W)	⑩- Supply voltage	D: DC48V
⑤-Rated speed	30: 30x100(rpm)	⑪- Motor version number	S: S version K: K version
⑥-Encoder type	S: Singleturn communication type magnetoelectric encoder Q: Multiturn communication type magnetoelectric absolute encoder	⑫- Motor Outlet Type	A: Special socketfor common motor

Note: S: Singleturn communication type magnetoelectric encoder
Q: Multiturn communication type magnetoelectric absolute encoder

Note: The oil seal is an optional accessory, and it can be omitted if it is not necessary.

SMK series servo motor technical parameters table

Servo motor model	SMK series servo motor			
	SMK60S-0020-30□■K-5DSA	SMK60S-0040-30□■K-5DSA	SMK80S-0075-30□■K-5DKA	SMK80S-0100-30□■K-5DKA
Drive power supply voltage	48	48	48	48
Intermediate link DC voltage VDC				
Continuous Characteristics	Rated power Pn(W)	200	400	750
	Rated torque Tn(Nm)	0.64	1.27	2.39
	Rated speed Nn (rpm)	3000	3000	3000
	Rated current In(A)	5.7	10.6	19.2
MAX torque Tm(Nm)	1.92	3.81	7.17	9.54
MAX current Im (A)	18.2	33.9	62.7	81
Standstill torque Ts(Nm)	0.7	1.4	2.63	3.5
Standstill current Is(A)	6.27	11.7	21.1	28.4
Resistance cable R _c (Ω)	0.68	0.32	0.088	0.058
Inductance cable L _c (mH)	1.33	0.65	0.32	0.22
Electrical time constant τ _e (ms)	1.96	2.03	3.64	3.79
Mechanical time constant τ _m (ms)	1.3	0.98	0.687	0.63
	1.33(with brake)	1(with brake)	0.736(with brake)	0.66(with brake)
Reverse voltage constant K _e (V/krpm)	7.5	8	8.3	8.23
Torque constant K _t (Nm/A)	0.124	0.132	0.137	0.136
Rotor moment of inertia J _m (Kg·cm ²)	0.17	0.31	0.85	1.16
	0.174(with brake)	0.314(with brake)	0.91(with brake)	1.22(with brake)
Brake holding torque T(Nm)	2	2	4	4
Number of pole pairs	5	5	5	5
MAX voltage rising du/dt (KV/μs)	8	8	8	8
Insulation class	F	F	F	F
Max radial force Fr(N)	40	40	392	392
Max axial force Fa(N)	30	30	147	147
Weight G(Kg)	0.9	1.1	1.9	2.4
	1.3(with brake)	1.5(with brake)	2.6(with brake)	3.1(with brake)
Fuselage length L(mm)	66.5±1.5	89±1.5	100.5±1	112.5±1
	98±1.5(with brake)	116±1.5(with brake)	134.5±1	146.5±1
Cooling method	Totally enclosed, self-cooling			
Protection level	IP67, IP54 at the shaft end (Note: add oil seal IP54 at the shaft end, no oil seal Ip50)			
Operation Environment	Temperature	- 20~40°C		
	Humidity	Below 90% RH (no condensation)		
	Ambient environment	Keep away from corrosion, flammable gases, oil droplets, dust		
	Altitude	The highest altitude is 4000m. Above 1000m, the power will decrease by 1.5% for every		

Note: □ = S : Singleturn communication type magnetoelectric encoder ■ = A : Motor without holding brake
Q : Multiturn communication type magnetoelectric absolute encoder B : Motor with holding brake

SMK series servo motor dimensions

60 flange

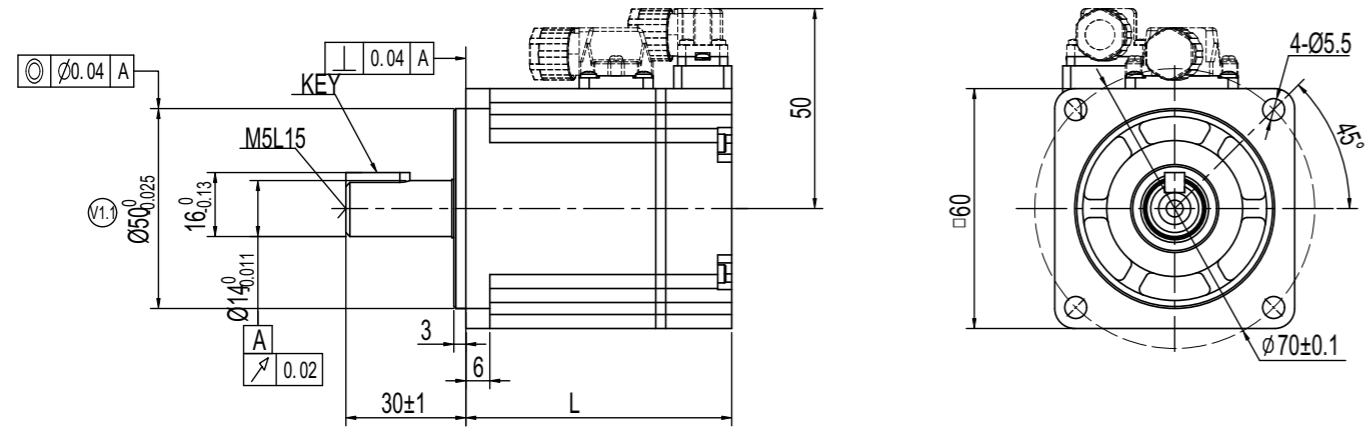

SMK series servo motor dimensions

80 flange

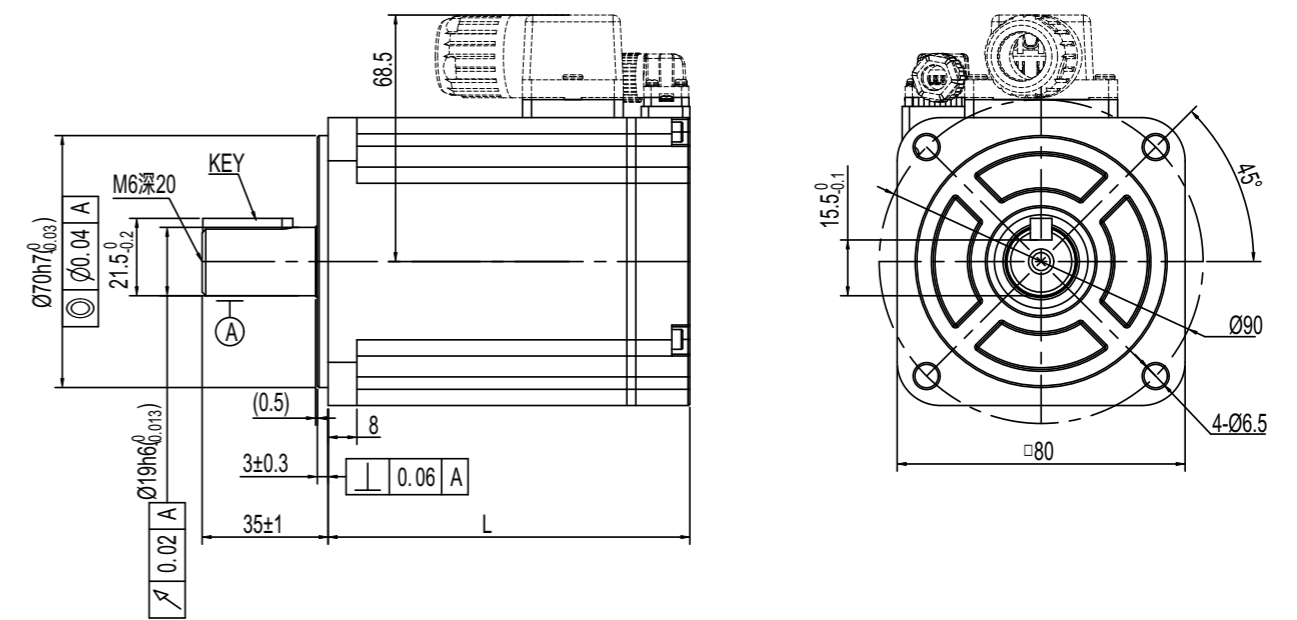

60 flanges (with brake)

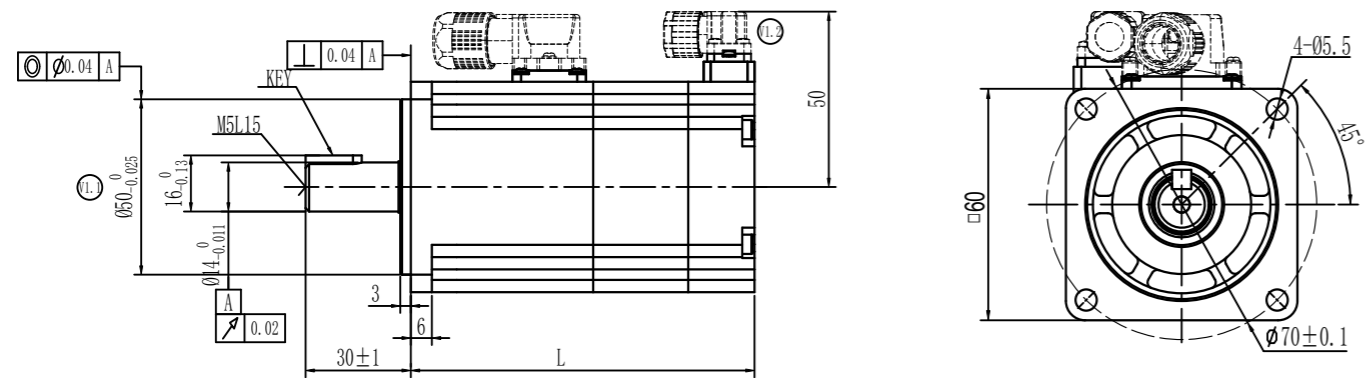

80 flanges (with brake)

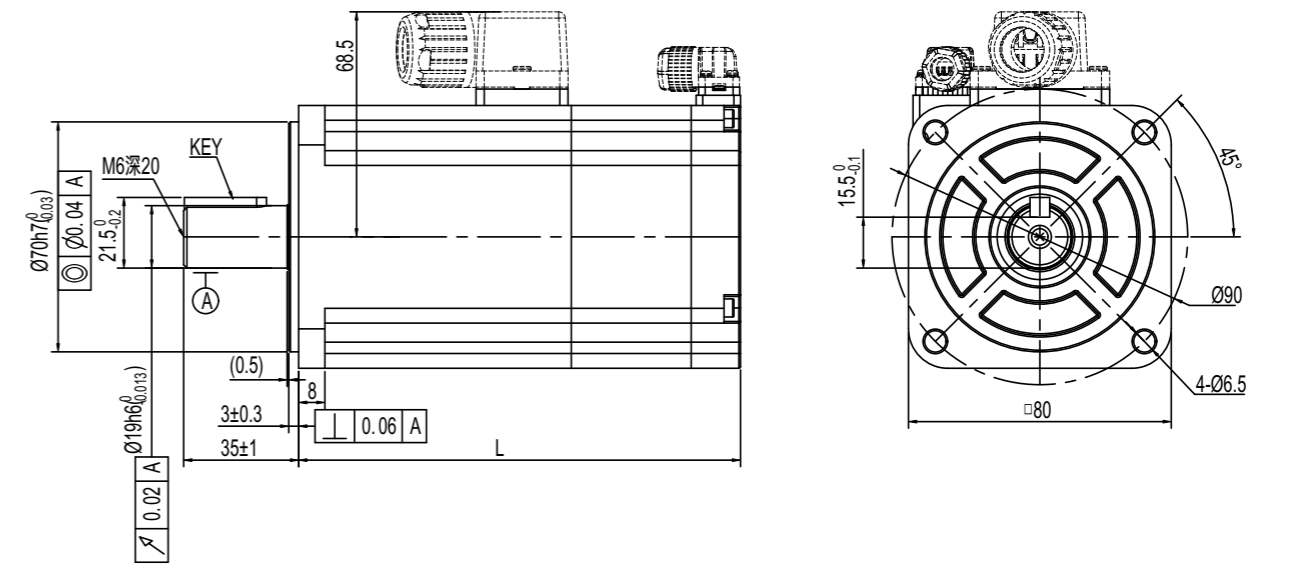

SMK series servo motor end connectors and wiring

Num	Definition
1	U
2	W
3	V
4	PE

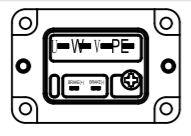

SMK60 power socket without brake

Num	Definition
1	U
2	W
3	V
4	PE

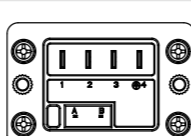

SMK80 power socket without brake

Num	Definition
1	U
2	W
3	V
4	PE
5	BRAKE(+)
6	BRAKE(-)

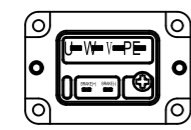

SMK60 power socket with

Num	Definition
1	U
2	W
3	V
4	PE
5	BRAKE(+)
6	BRAKE(-)

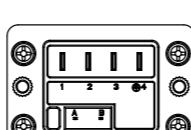

SMK80 power socket with brake

Num	Definition
1	DC +5V
2	GND
3	NC
4	NC
5	485+
6	485-

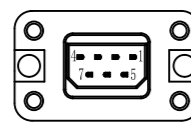

Encoder socket single turn

Num	Definition
1	DC +5V
2	GND
3	VB+
4	VB-
5	SD+
6	SD-

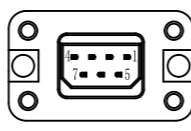

Encoder socket multiturn

SMK series servo motor curve

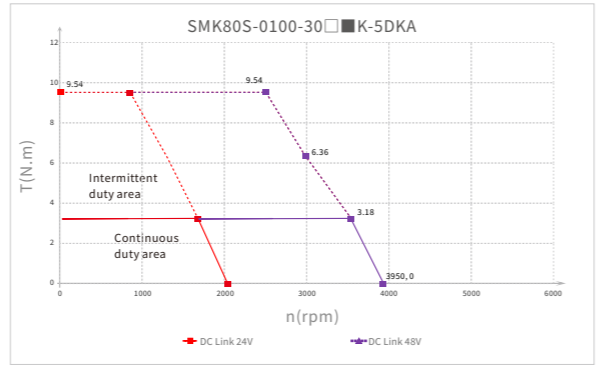
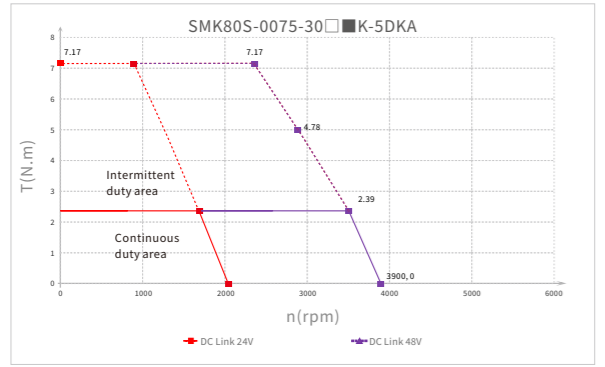
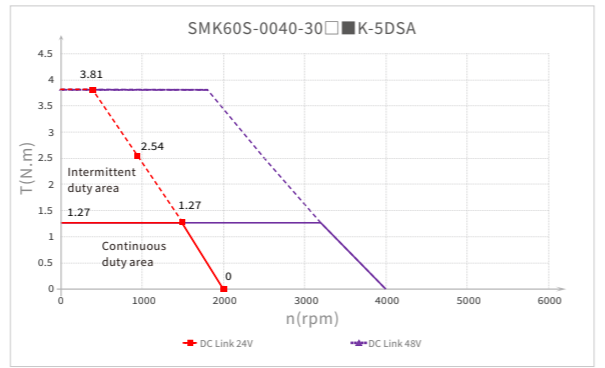
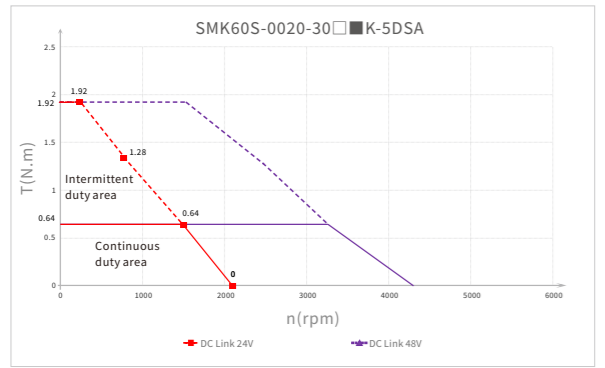

Cable naming rules

Power cable:

Model: MOT F - 005 - LL - KAB - D

① ② ③ ④ ⑤ ⑥

①-Cable function type	MOT: Motor power cable	④ -Cable length	(5) :0.5m 01:1m 02:2m 03:3m
②-Cable type	F: Flexible cable Empty: Common cable	⑤-Motor outlet type	KA: Pluggable motor connector (power) KAB: Pluggable motor connector (power and brake)
③-Rated current	005: 5A 011: 11A 020: 20A 030: 30A	⑥-Connector types	D: DC servo standard connector

Encoder cable/encoder battery cable

Model: ENC D G F - LL - G A - DC

① ② ③ ④ ⑤ ⑥ ⑦ ⑧

①-Cable function type	ENC: Motor encoder cable	⑤-Cable length	(5) :0.5m 01:1m 02:2m 03:3m
②-Drive encoder connector type	D: 1394 connector H: Three rows of 15DB connectors	⑥-Core cable type	G: 6-core cable
③-Drive connector definition	G: Communication type connector	⑦-Type of encoder connector to the motor end	A: Pluggable encoder connector U: 1394 connector
④-Cable type	F: Flexible cable Empty: Common cable	⑧-Cable accessories	DC: With battery box outlet wire Empty: Without battery box outlet wire

Wiring drawing

ENCHG-LL-GA

Wire specification: 1P22AWG+2P26AWG standard cable
 22AWG corresponds to a cross-sectional area of 0.3247mm²
 26AWG corresponds to a cross-sectional area of 0.1281mm²

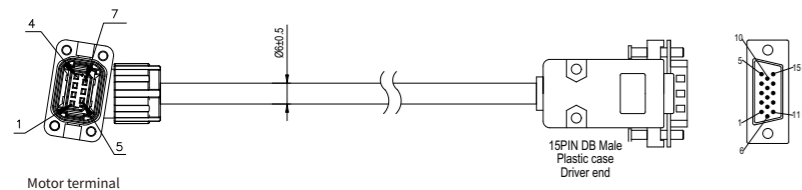

Motor end	Color	Signal	15PIN DB Male
PIN1	Red	VDD	PIN1
PIN2	Orange	GND	PIN2
PIN3	/	/	/
PIN4	/	/	/
PIN5	Blue	485+	PIN9
PIN6	Purple	485-	PIN14
Outer shell	Shielded wire	Shield	Shield

Note :Corresponding kit ENCHG-GA

ENCHGF-LL-GA

Wire specification: 1P22AWG+2P26AWG flexible drag chain cable
 22AWG corresponds to a cross-sectional area of 0.3247mm²
 26AWG corresponds to a cross-sectional area of 0.1281mm²

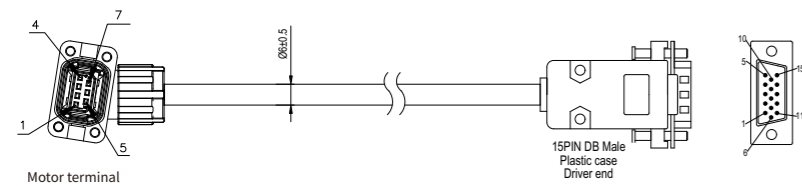

Motor end	Color	Signal	15PIN DB Male
PIN1	Red	VDD	PIN1
PIN2	Orange	GND	PIN2
PIN3	/	/	/
PIN4	/	/	/
PIN5	Blue	485+	PIN9
PIN6	Purple	485-	PIN14
Outer shell	Shielded wire	Shield	Shield

Note :Corresponding kit ENCHG-GA

ENCDG-LL-GA

Wire specification: 1P22AWG+2P26AWG standard cable
 22AWG corresponds to a cross-sectional area of 0.3247mm²
 26AWG corresponds to a cross-sectional area of 0.1281mm²

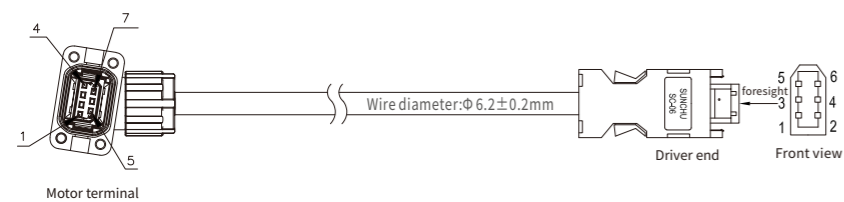

Motor end	Color	Signal 1	Signal 2	SC06 Male
PIN1	red	VDD	VDD	PIN1
PIN2	Orange	GND	GND	PIN2
PIN3	Brown	MA_P+	/	PIN3
PIN4	Black	MA_N-	/	PIN4
PIN5	Blue	SLO_P+	SD	PIN5
PIN6	Purple	SLO_N-	/SD	PIN6
Outer shell	Shielded wire	Shield	Shield	Shield

Note: Signal 1 for magnetolectric encoders,
 signal 2 for absolute encoders;
 Corresponding kit: ENCDG/ENCDGF-GA

Wiring drawing

ENCDGF-LL-GA

Wire specification: 1P22AWG+2P26AWG flexible drag chain cable
 22AWG corresponds to a cross-sectional area of 0.3247mm²
 26AWG corresponds to a cross-sectional area of 0.1281mm²

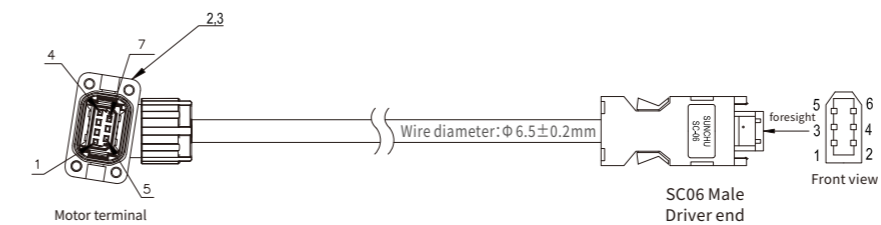

Motor end	Color	Signal 1	Signal 2	SC06 Male
PIN1	red	VDD	VDD	PIN1
PIN2	Orange	GND	GND	PIN2
PIN3	Brown	MA_P+	/	PIN3
PIN4	Black	MA_N-	/	PIN4
PIN5	Blue	SLO_P+	SD	PIN5
PIN6	Purple	SLO_N-	/SD	PIN6
Outer shell	Shielded wire	Shield	Shield	Outer shell

Note: Signal 1 for magnetolectric encoders,
 signal 2 for absolute encoders;
 Corresponding kit: ENCDG/ENCDGF-GA

ENCHG-(4)-GU-DC

Wire specification: 3×2 ×0.2mm²

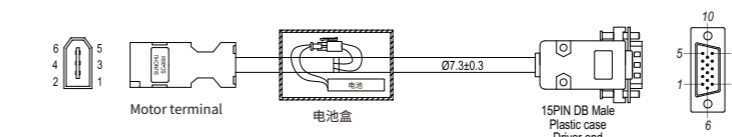

ENCHG-(4)-GU-DC					
Motor end	Color	Black HSG	External single line	Signal	15PIN DB Male
PIN1	red	/	/	+5V	PIN1
PIN2	black	/	/	GND	PIN2
PIN3	brown	PIN1	Red	BAT+	/
PIN4	blue	PIN2	Black	BAT-	/
PIN5	Yellow	/	/	SD	PIN9
PIN6	Green	/	/	/SD	PIN14
Outer shell	Shielded wire	/	/	Shield	Outer shell

MOT-005-LL-KA-D

Wire specification: 4C*20AWG 300V standard cable
 20AWG corresponds to a cross-sectional area of 0.5189mm²

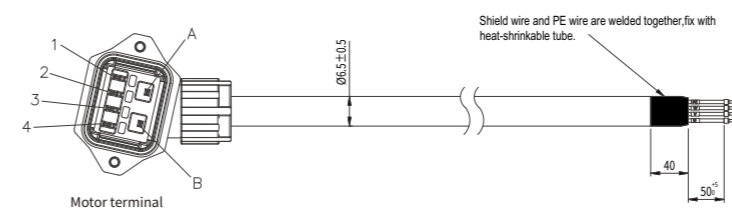

Motor end	Color	Signal
PIN1	White	U
PIN2	Black	W
PIN3	Red	V
PIN4	Yellowgreen+Shielding	PE

Note: Corresponding kit MOT/MOTF-005-KA

Wiring drawing

MOTF-005-LL-KA-D

Wire specification: 4C*20AWG 300V flexible drag chain cable
20AWG corresponds to a cross-sectional area of 0.5189mm²

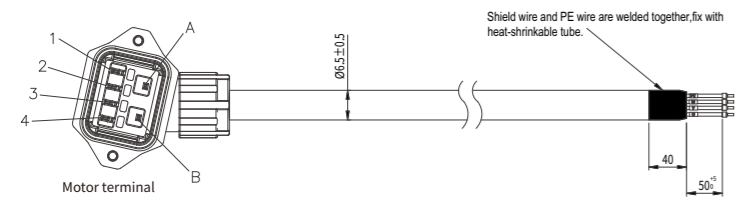

Motor end	Color	Signal
PIN1	White	U
PIN2	Black	W
PIN3	Red	V
PIN4	Yellowgreen+Shielding	PE

Note: Corresponding kit MOT/MOTF-005-KA

Wiring drawing

MOT-011-LL-KA-D

Wire specification: 4C*16AWG 300V standard cable
16AWG corresponds to a cross-sectional area of 1.318mm²

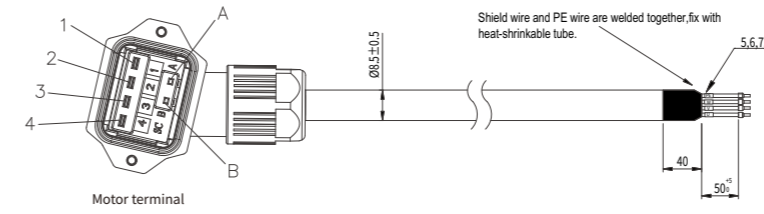

Motor end	Color	Signal
PIN1	White	U
PIN2	Black	W
PIN3	Red	V
PIN4	Yellowgreen+Shielding	PE

Note: Corresponding kit MOT-011-KA

MOT-005-LL-KAB-D

Wire specification: 4C*18AWG+1P*24AWG standard cable
18AWG corresponds to a cross-sectional area of 0.8107mm²
24AWG corresponds to a cross-sectional area of 0.2047mm²

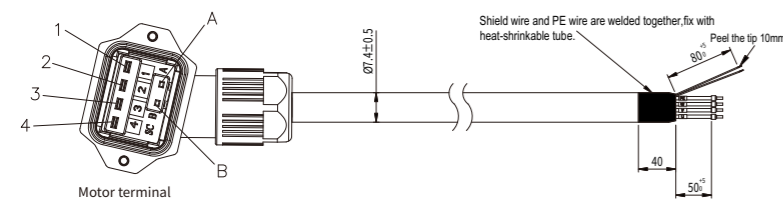

Motor end	Color	Signal
PIN1	White	U
PIN2	Black	W
PIN3	Red	V
PIN4	Yellowgreen+Shielding	PE
PINA	Brown	BRAKE+
PINB	Blue	BRAKE-

Note: Corresponding kit MOT-011-KA

MOTF-011-LL-KA-D

Wire specification: 4C*16AWG 300V flexible drag chain cable
16AWG corresponds to a cross-sectional area of 1.318mm²

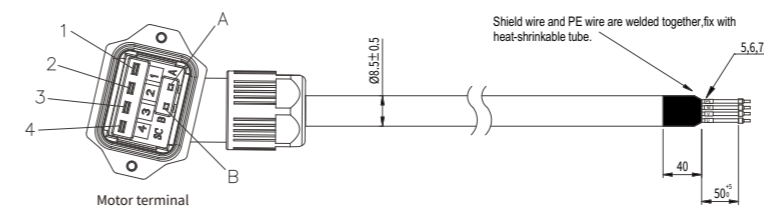

Motor end	Color	Signal
PIN1	White	U
PIN2	Black	W
PIN3	Red	V
PIN4	Yellowgreen+Shielding	PE

Note: Corresponding kit MOT-011-KA

MOTF-005-LL-KAB-D

Wire specification: 4C*18AWG+1P*24AWG flexible drag chain cable
18AWG corresponds to a cross-sectional area of 0.8107mm²
24AWG corresponds to a cross-sectional area of 0.2047mm²

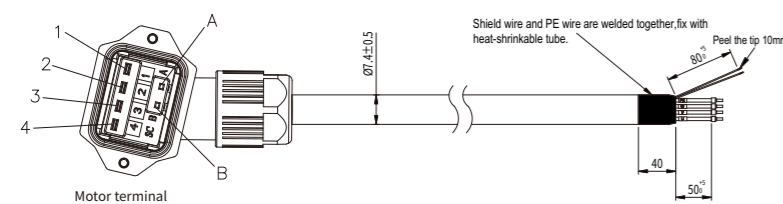

Motor end	Color	Signal
PIN1	White	U
PIN2	Black	W
PIN3	Red	V
PIN4	Yellowgreen+Shielding	PE
PINA	Brown	BRAKE+
PINB	Blue	BRAKE-

Note: Corresponding kit MOT-011-KA

MOT-011-LL-KAB-D

Wire specification: 4C*16AWG+1P*24AWG standard cable
16AWG corresponds to a cross-sectional area of 1.318mm²
24AWG corresponds to a cross-sectional area of 0.2047mm²

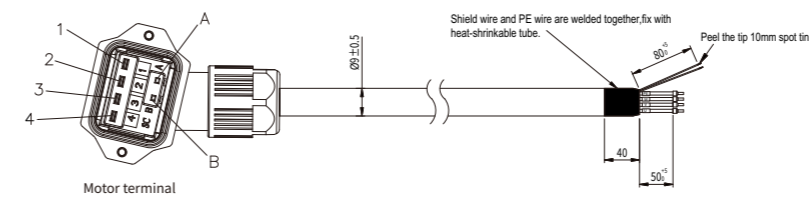

Motor end	Color	Signal
PIN1	White	U
PIN2	Black	W
PIN3	Red	V
PIN4	Yellowgreen+Shielding	PE
PINA	Brown	BRAKE+
PINB	Blue	BRAKE-

Note: Corresponding kit MOT-011-KA

Wiring drawing

MOTF-011-LL-KAB-D

Wire specification: 4C*16AWG+1P*24AWG flexible drag chain cable
 16AWG corresponds to a cross-sectional area of 1.318mm²
 24AWG corresponds to a cross-sectional area of 0.2047mm²

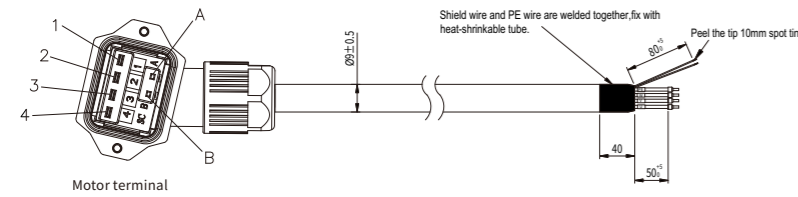

Motor end	Color	Signal
PIN1	White	U
PIN2	Black	W
PIN3	Red	V
PIN4	Yellowgreen+Shielding	PE
PINA	Brown	BRAKE+
PINB	Blue	BRAKE-

Note: Corresponding kit MOT-011-KA

MOT-020-LL-KA-D

Wire specification: UL2586 4x13AWG standard cable
 13AWG corresponds to a cross-sectional area of 2.627mm²

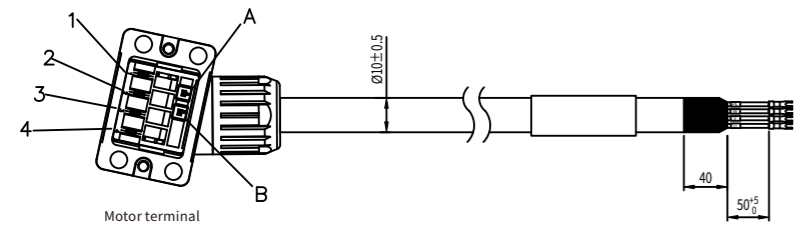

Motor end	Color	Signal
PIN1	White	U
PIN2	Black	W
PIN3	Red	V
PIN4	Yellowgreen+Shielding	PE

MOTF-020-LL-KA-D

Wire specification: UL2586 4x13AWG flexible drag chain cable
 13AWG corresponds to a cross-sectional area of 2.627mm²

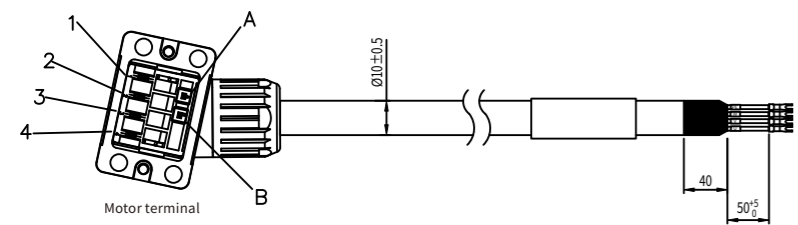

Motor end	Color	Signal
PIN1	White	U
PIN2	Black	W
PIN3	Red	V
PIN4	Yellowgreen+Shielding	PE

Wiring drawing

MOT-020-LL-KAB-D

Wire specification: UL25864Cx13AWG+1Px20AWG standard cable
 13AWG corresponds to a cross-sectional area of 2.627mm²
 20AWG corresponds to a cross-sectional area of 0.5189mm²

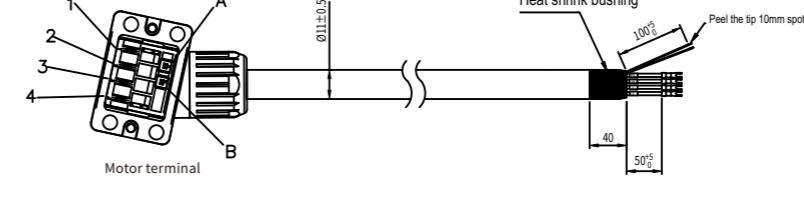

Motor end	Color	Signal
PIN1	White	U
PIN2	Black	W
PIN3	Red	V
PIN4	Yellowgreen+Shielding	PE
PINA	Brown	BRAKE+
PINB	Blue	BRAKE-

MOTF-020-LL-KAB-D

Wire specification: UL25864Cx13AWG+1Px20AWG flexible drag chain cable
 13AWG corresponds to a cross-sectional area of 2.627mm²
 20AWG corresponds to a cross-sectional area of 0.5189mm²

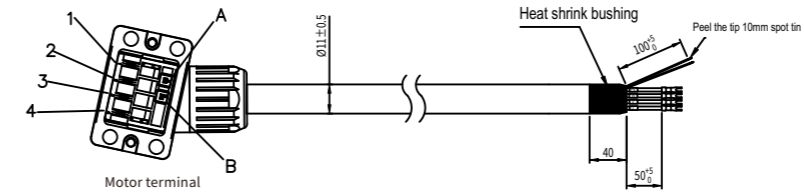

Motor end	Color	Signal
PIN1	White	U
PIN2	Black	W
PIN3	Red	V
PIN4	Yellowgreen+Shielding	PE
PINA	Brown	BRAKE+
PINB	Blue	BRAKE-

MOT-030-LL-KA-D

Wire specification: UL2586 4x12AWG standard cable
 12AWG corresponds to a cross-sectional area of 3.332mm²

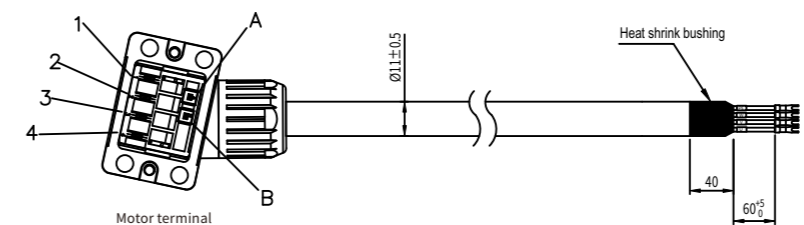

Motor end	Color	Signal
PIN1	White	U
PIN2	Black	W
PIN3	Red	V
PIN4	Yellowgreen+Shielding	PE

Wiring drawing

MOTF-030-LL-KA-D

Wire specification: UL2586 4x12AWG flexible drag chain cable
 12AWG corresponds to a cross-sectional area of 3.332mm²

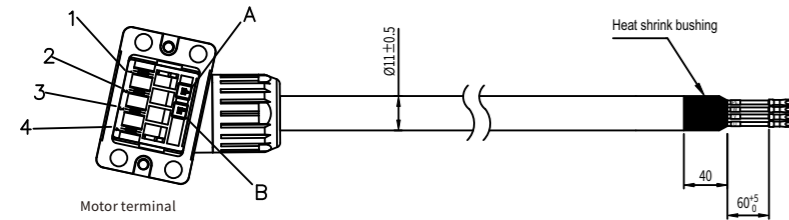

Motor end	Color	Signal
PIN1	White	U
PIN2	Black	W
PIN3	Red	V
PIN4	Yellowgreen+Shielding	PE

MOT-030-LL-KAB-D

Wire specification: UL2586 4Cx12AWG+1Px20AWG standard cable
 12AWG corresponds to a cross-sectional area of 3.332mm²
 20AWG corresponds to a cross-sectional area of 0.5189mm²

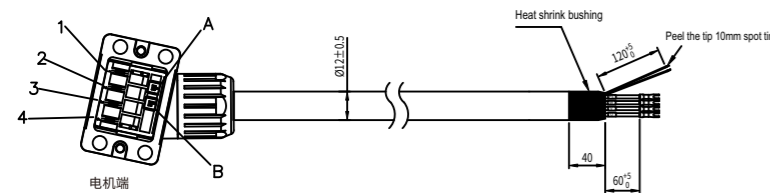

Motor end	Color	Signal
PIN1	White	U
PIN2	Black	W
PIN3	Red	V
PIN4	Yellowgreen+Shielding	PE
PINA	Brown	BRAKE+
PINB	Blue	BRAKE-

MOTF-030-LL-KAB-D

Wire specification: UL2586 4Cx12AWG+1Px20AWG flexible drag chain cable
 12AWG corresponds to a cross-sectional area of 3.332mm²
 20AWG corresponds to a cross-sectional area of 0.5189mm²

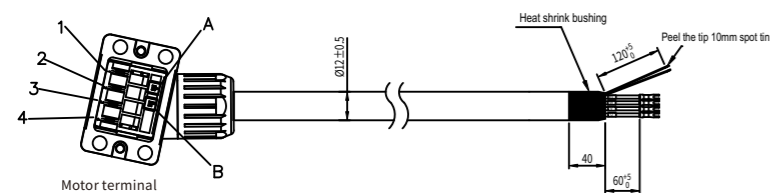

Motor end	Color	Signal
PIN1	White	U
PIN2	Black	W
PIN3	Red	V
PIN4	Yellowgreen+Shielding	PE
PINA	Brown	BRAKE+
PINB	Blue	BRAKE-