

## 安装说明

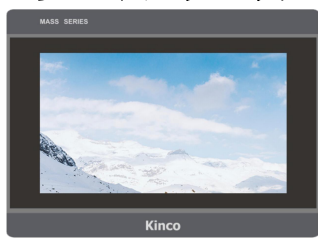

深圳市步科电气有限公司



电话: 0755-26585555

传真: 0755-26616372

技术支持热线: 400-700-5281

http://www.kinco.cn Email: sales@kinco.cn

步科官方微信 地址: 深圳市南山区高新科技园北区朗山一路6号一栋

## 1. 安装注意事项

## 1.1 环境要求

工作环境温度: M2070H/M2070HE 人机界面的设计规范可以保证它能够在 32°F~122°F (0~50°C) 的大多数工业环境中稳定工作。NEMA 防护规定: M2070H/M2070HE 人机界面的前面板符合 NEMA1 的防护规定。

## 请勿在以下场所使用:

- 阳光直射处
- 周围温度和相对湿度超出规格的场所
- 温度急剧变化易引起结露的场所
- 有腐蚀性气体和可燃性气体的场所
- 尘埃、灰尘、盐分、铁粉较多的场所
- 会被溅到水、油、药品等飞沫的场所
- 给主机带来直接振动和冲击的场所

## 在以下场所使用时请采取屏蔽措施:

- 有静电或其它形式噪音处
- 有较强电磁场的场所
- 可能暴露于射线的场所
- 靠近于动力电源的场所

## 1.2 电源要求

- 输入电压: DC10.8V~DC28V;
  - 特别需要注意与变频调速器和开关电源供应器保持较远的距离, 这类设备的输入和输出电缆都必须采用屏蔽电缆, 并将屏蔽网接到系统的星形接地点;
  - 直流电源必须与交流主电源正确的隔离开;
  - 不要让 M2070H/M2070HE 人机界面和感性负载或控制器的输入电路共用电源。
- 注意:** 产品内部的快速熔丝在电源电压过高的时候可以起到保护作用, 但并不能够确保内部电子元件不被损坏。

## 2. 产品安装

## 2.1 尺寸图

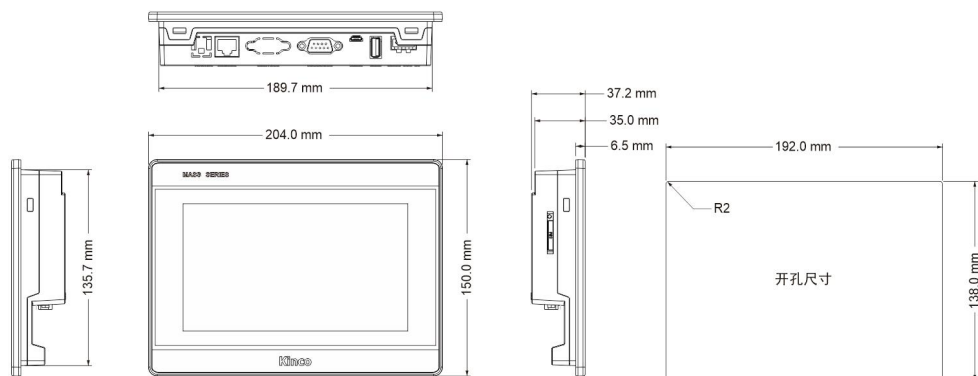

## 2.2 固定螺钉安装说明

将产品放入机器设备控制面板上已开好的安装孔中, 从控制面板背面将安装卡扣卡入 HMI 壳体上的安装方孔中, 然后拧紧螺钉, 推荐扭力: 0.5N.m (以达到防水、防尘效果及避免外壳变形)。

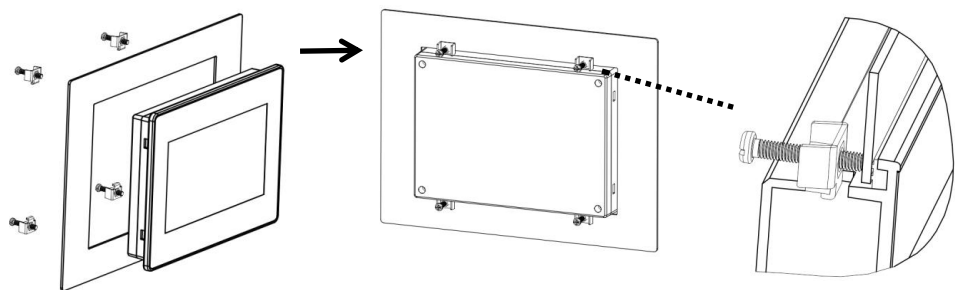

## 2.3 电源连接

在连接电源前, 请确认符合所有当地和国家的电气标准。电源线缆请选择耐压值和电流值符合安全规定的线缆。

将产品背面接线端子的螺丝按逆时针方向旋松, 插入电源电缆, 然后顺时针拧紧接线端子的螺丝。**注意:** 将电源的正极接到标有 'DC24V' 的端子上, 直流的地接到标有 'GND' 的端子上, 地线接到标有 'FG' 的端子上

## 3. 外部接口

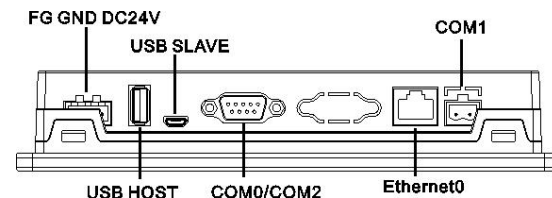
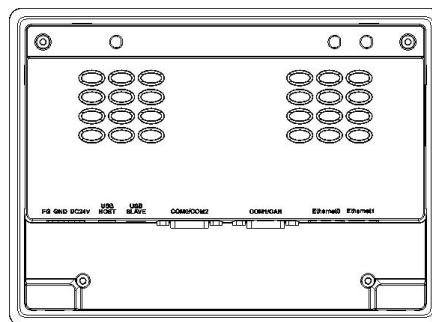

## 3.1 电源端子

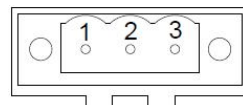

序号	含义
1	DC24V
2	GND
3	FG

## 3.2 COM0/COM2

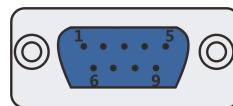

COM0/COM2 通讯端口是 9 针 D 型公座。**注意:** COM0 支持 RS232/485/422 通讯功能, 一个串口同时只能支持一种协议。COM2 只支持 RS232 通讯功能。

管脚	信号	COM0 [RS-422]	COM0 [RS-485]	COM0 [RS-232]	COM2 [RS-232]
1	Rx- (B)	RS422 R-	RS485 B		
2	RxD_PLC			RS232 RxD	
3	TxD_PLC			RS232 TxD	
4	Tx-	RS422 T-			
5	GND	信号地			
6	Rx+ (A)	RS422 R+	RS485 A		
7	RxD_PC				RS232 RxD
8	TxD_PC				RS232 TxD
9	Tx+	RS422 T+			

## 3.3 USB HOST 接口

连接	连接 USB 接口设备或 U 盘
端口作用	连接 USB 接口键盘、鼠标、打印机等, 插入 U 盘上传/下载程序以及存储数据

## 3.4 USB SLAVE 接口

接口类型是 *MicroUSB*。

连接	通过一条通用的 USB 通讯电缆和 PC 机连接
端口作用	上/下载用户组态程序和设置 HMI 系统参数



**注意:** USB HOST 接口与 USB SLAVE 接口为分时复用, 应避免同时使用!

## 3.5 以太网接口(M2070HE 支持)

10M/100M 自适应以太网 RJ45 端口。

连接	采用五类 UTP 网线与带网口的设备连接
端口作用	用于 HMI 组态的上/下载, 系统参数的设置和在线模拟; 构成多 HMI 联机; 与 PLC 等通过以太网通讯; 通过以太网口与 PC 机通讯

## 3.6 COM1

COM1 通讯端口是 2pin 端子。**注意:** COM1 支持 RS485 通讯功能。

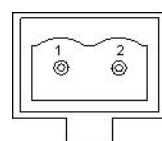

管脚	信号
1	Rx+ (A)
2	Rx- (B)

## 4. 售后服务

《人机界面售后服务条款》请登录如下网址查看: <http://www.kinco.cn>

# Installation Instruction

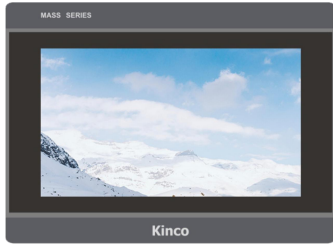

## Kinco Electric (Shenzhen) Ltd.

Add: Building 1, No. 6 Langshan 1st Rd, Hi-tech Park North, Nanshan, Shenzhen, China.  
 Tel: 0755-26585555 Fax: 0755-26616372 <http://www.kinco.cn> Email: sales@kinco.cn

## 1. Installation Note

### 1.1 Environmental Requirement

Operating temperature: M2070H/M2070HE HMI can work stably in most industrial environments that the temperature between 32°F to 122°F (0~50°C).

NEMA rating: This Series HMI frontpanel is NEMA 1 rated.

#### Please do not use in the following places:

- Places direct in sunlight
- Surrounding temperature and humidity beyond the specifications
- Places of temperature changes sharply and easily cause condensation
- Places that exist corrosive gas and combustible gas
- Places of much dust, dirt, salt and iron powder
- Places that will be splashed water, oil and drugs
- Places that bring direct vibration and shock to host

#### Please take shielding measures in the following places:

- Places that exist electrostatic or other kinds of noise
- Places of strong electromagnetic
- Places that may be exposed to rays
- Places near the power

### 1.2 Power Requirement

- Input voltage: DC10.8 V~DC28V.
- Particularly note that there must be enough distance between this product and converters or switch mode power supply. Make sure that the input and output cables of that kind equipment are shield cable and the shielding network is connected with the ground.
- Make sure that the DC power and AC power is isolated.
- Do not use common power with perceptual load or input circuit of the controller.

**Note:** An Internal fuse will prevent damage for over voltage condition, however it isn't guaranteed the internal electronic components are not damaged.

## 2. Installation Description

### 2.1 Dimensional Drawing

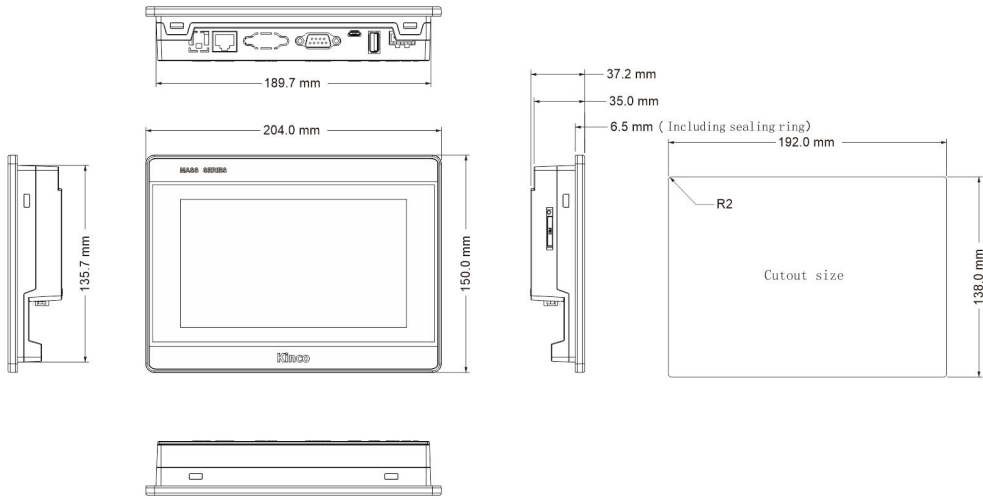

### 2.2 Fixed Screw Installation Instructions

The product is put into the well mounted hole of the machine control box's panel, and the mounting screws are inserted into the fixing holes around the HMI shell from the back of the control box's panel. Recommended lock torque: 0.5N.m (to waterproof effect and avoid shell deformation)

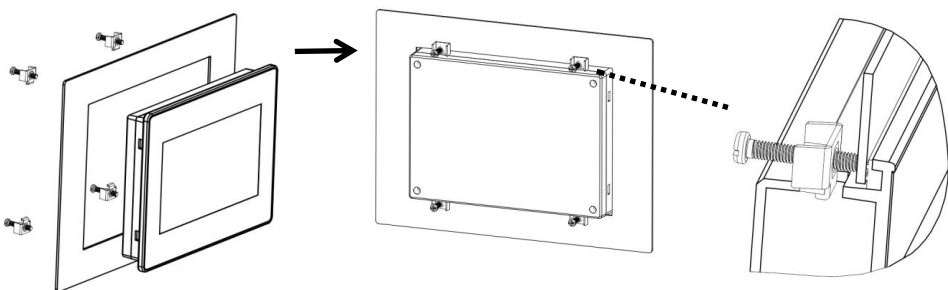

### 2.3 Power Connection

Before connecting the power, please make sure all local and national electrical standards are met. For power cables, please select cables with their dielectric strength values and current values in compliance with the safety specifications.

First find the power terminal at the back of the product and loosen the screw according to counterclockwise, then insert the power cables and tighten the screw up.

Connect positive DC line to the 'DC24V' terminal, the DC ground to the 'GND' terminal and the ground line to the 'FG' terminal.

## 3. External Interface

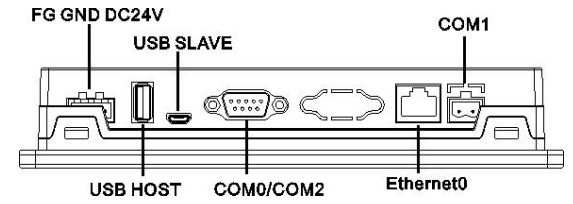
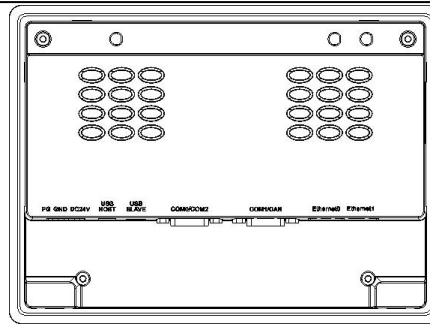

### 3.1 POWER

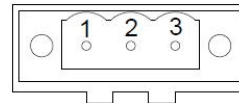

Pin#	Signal
1	DC24V
2	GND
3	FG

Pin	Signal	PLC (COM0) [RS-422]	PLC (COM0) [RS-485]	PLC (COM0) [RS-232]	PC/PLC (COM2) [RS-232]
1	Rx- (B)	RS422 R-	RS485 B		
2	RxD_PLC			RS232 RxD	
3	TxD_PLC			RS232 TxD	
4	Tx-	RS422 T-			
5	GND	Signal ground			
6	Rx+(A)	RS422 R+	RS485 A		
7	RxD_PC				RS232 RxD
8	TxD_PC				RS232 TxD
9	Tx+	RS422 T+			

### 3.2 COM0/COM2

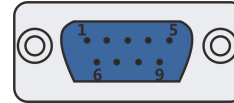

Pin assignment of the 9-pin male, D-SUB, COM0/COM2. **Note:** RS232/485/422 communication functions are supported by COM0. COM2 supports RS232 communication function.

### 3.3 USB HOST

<b>Connection</b>	Connect with USB interface devices or U disks
<b>Port Function</b>	This interface can be connected with USB keyboard, mouse and printers, and the U disk can be used for user's configuration uploading/ downloading as well as data storage.

### 3.4 USB SLAVE

The interface type is MicroUSB

<b>Connection</b>	USB Slave port can be connected with a PC
<b>Port Function</b>	The port is only used to download user configuration program to the HMI and to set HMI system parameters.



**Note:** USB HOST interface and USB SLAVE interface are time-sharing multiplexing, and should not be used at the same time!

### 3.5 Ethernet (M2070HE support)

10M/100M adaptive Ethernet RJ45 port.

<b>Connection</b>	With CAT5 UTP cable connected to the Ethernet device.
<b>Port Function</b>	The port can be used for upload/download of HMI configuration, setting of system parameters and online simulations of configurations. It can connect multiple HMIs via the Ethernet to form an HMI network. Furthermore, it can implement communications between HMI and PLC via the Ethernet, as well as communications with a PC via the Ethernet port.

### 3.6 COM1

2-pin terminal blocks, COM1. **Note:** COM1 supports RS485.

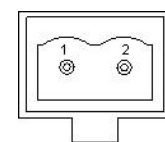

Pin	Signal
1	Rx+(A)
2	Rx-(B)

## 4. After-sales Service

For < Service Terms and Conditions for HMI >, please check: <http://www.kinco.cn>